

12' x 16'

**HARDTOP GAZEBO
WITH DOUBLE ROOF**

Assembly Manual

Warnings and Cautions

Please retain this instruction for future usage and read carefully before assembly.

Make sure you have all the parts & hardware as item list shows.

2 adults or more are recommended to install your gazebo.

Do not discard any of the packaging until you have checked that you have all the parts and pack of fittings.

Check all bolts for tightness before use, and periodically check and tighten bolts ensure your gazebo works properly.

Some parts might have sharp edges/corners. Please follow basic safety precautions to reduce the risk of hurts.

*Maximum weight capacity is **1000 pounds**.*

*It is essential to place the gazebo on level ground and not less than **6 feet** from any obstruction such as fences, garages, the house, overhanging branches, laundry lines, or electrical wires.*

CHOKER HAZARD

**THIS ITEM CONTAINS SMALL PARTS WHICH CAN BE SWALLOWED BY CHILDREN.
PLEASE KEEP IT AWAY FROM CHILDREN UNDER 3 YEARS OLD and PETS DURING
INSTALLATION.**

Pre-assembly

TOOLS THAT MAY BE REQUIRED (Not included in boxes)

*NOTE: Tools / equipment are not shown to actual size and scale.



LEVEL

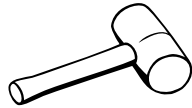

RUBBER Mallet



PHILLIPS SCREW



DRILL

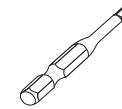

ALLEN KEY

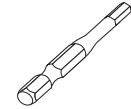

ALLEN KEY

EQUIPMENT REQUIRED (Not included in boxes)

*NOTE: Equipment are not shown to actual size and scale.



SAFETY HAT



GLOVES



SAFETY GOGGLES



STEPLADDER

Matters needing attention



1. Two or more people are required for assembly.



2. Do not fully tighten screws prior to complete assembly.

MOUNTING BLUEPRINT

Gazebo 12×16

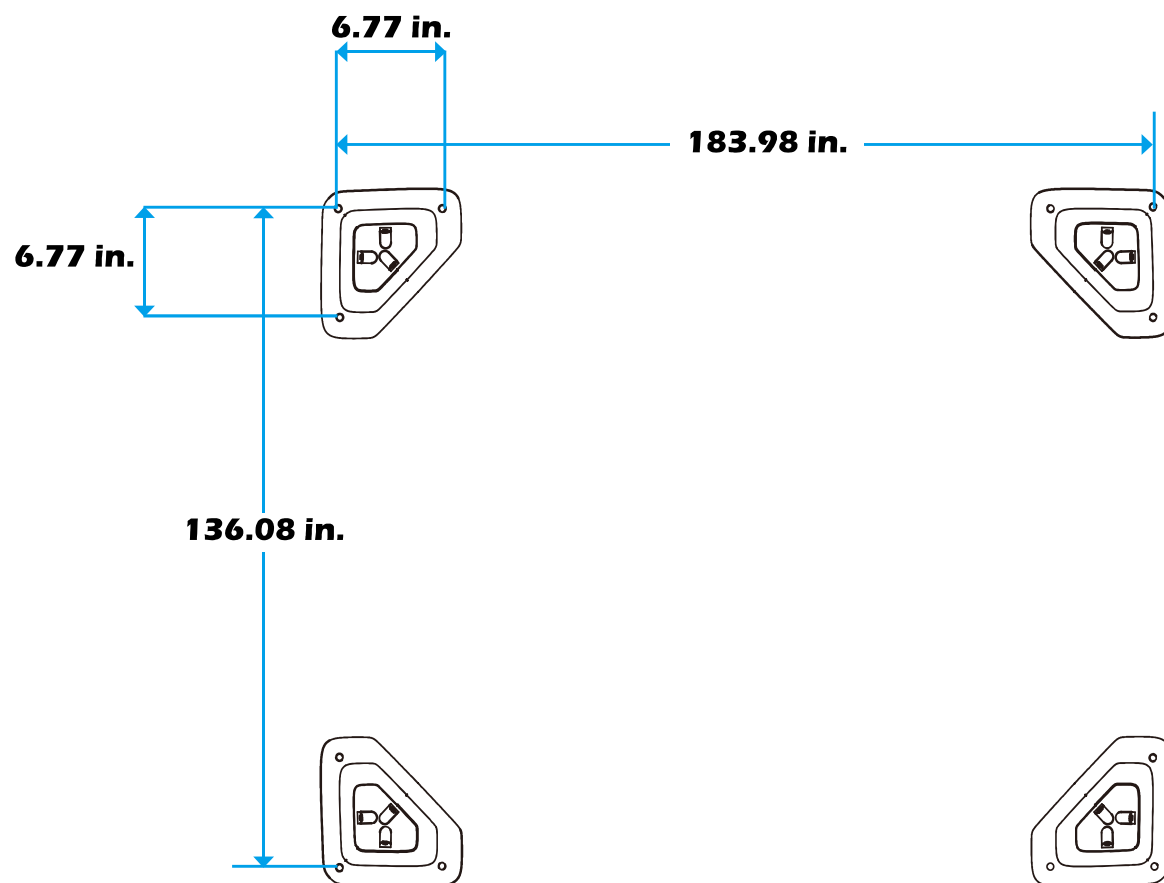

1

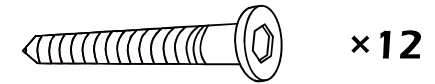
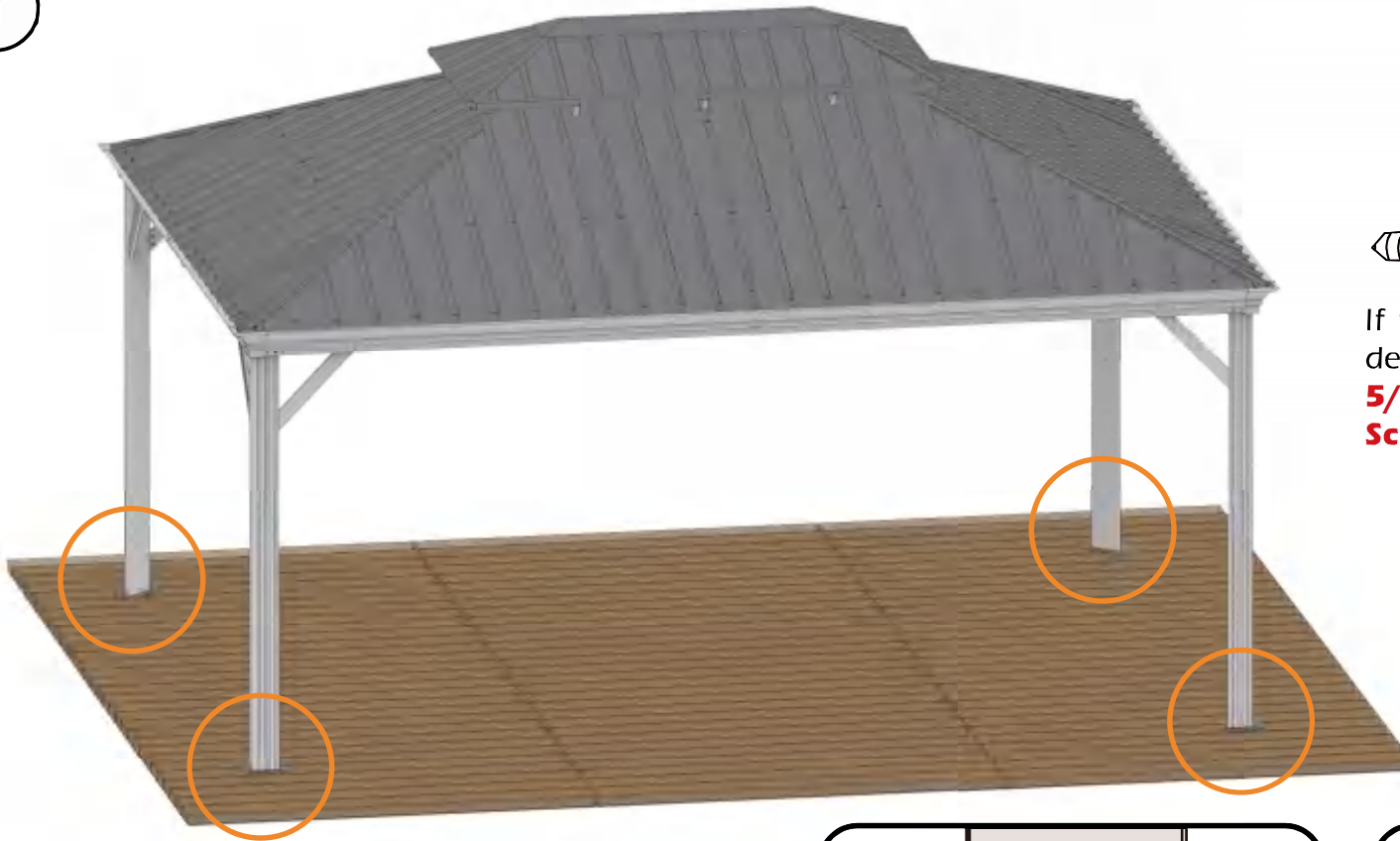

If the deck is hard wood and the depth of it is over 3 inch, you can use **5/16 in. ×4 in. Structural Wood Screw** to mount the gazebo.

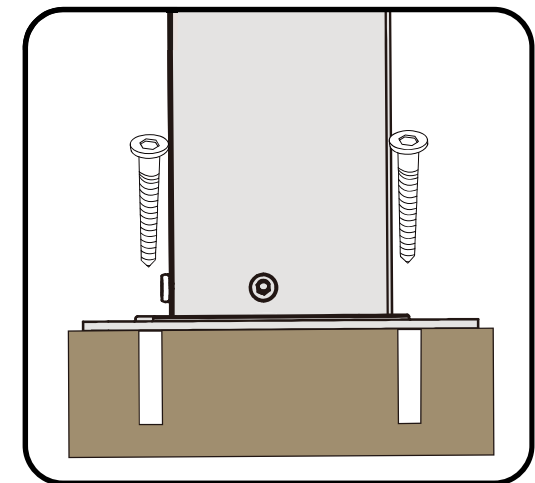
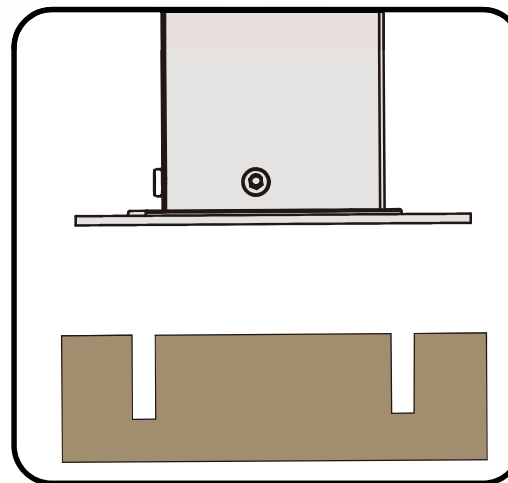

2

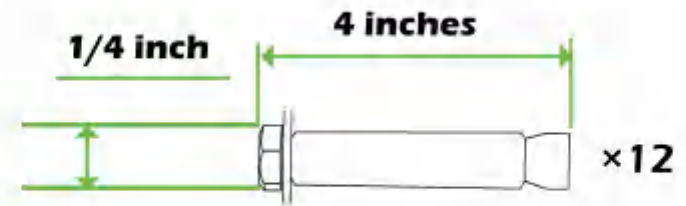
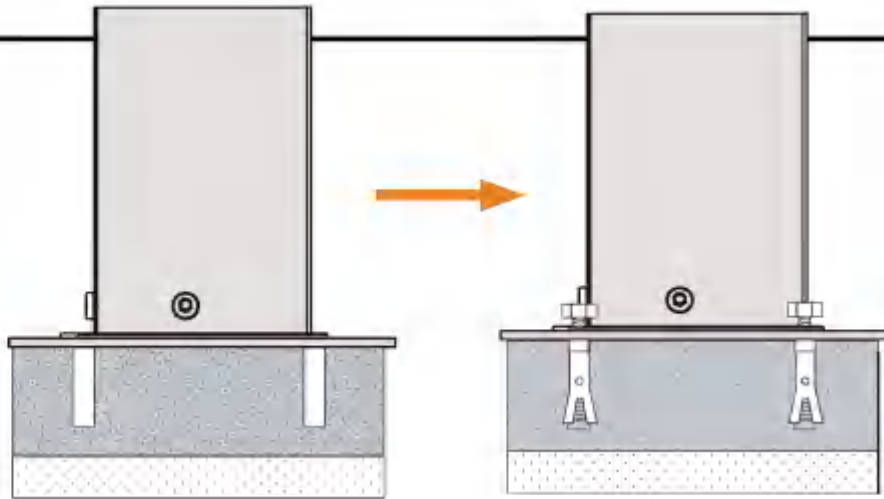

If the ground is concreted and the depth of it is over 3 inch, you can use 1/4 inch expansion bolts to mount the gazebo

3

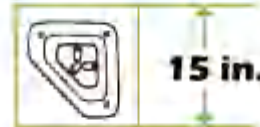

Or you can make a concrete footing for gazebo, **15×15×15 inches** is recommended, use expansion bolts to mount the pergola like ② shows.

IMPORTANT:
Anchor is not recommended



CHECK LIST

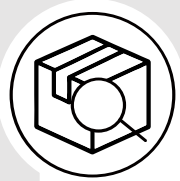

A × 4



B × 2

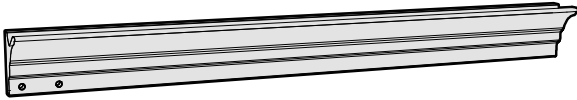

B1 × 2



B2 × 2



C × 2

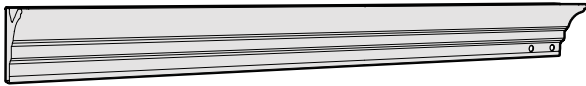

C1 × 2



C2 × 2



D × 2

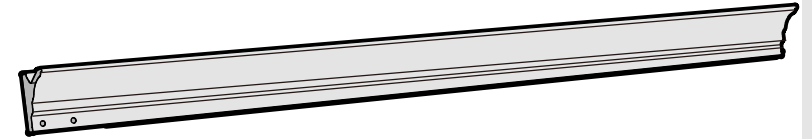

D1 × 2

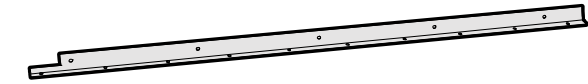

D1a × 2



D2 × 2



E × 2

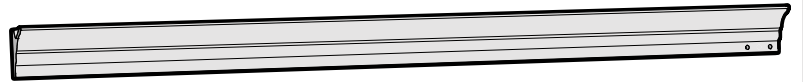

E1 × 2

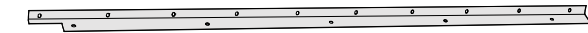

E1a × 2



E2 × 2



F × 4

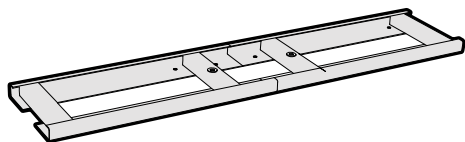

G × 4

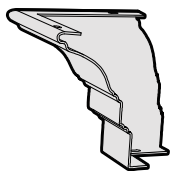

H × 4

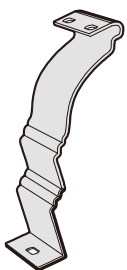

H1 × 4

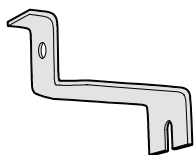

H2 × 1

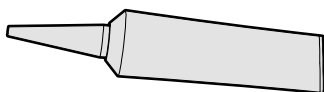

J1 × 4



J2 × 4



K × 1

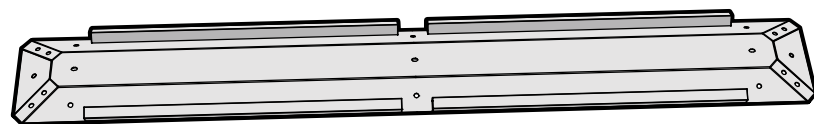

K1 × 1

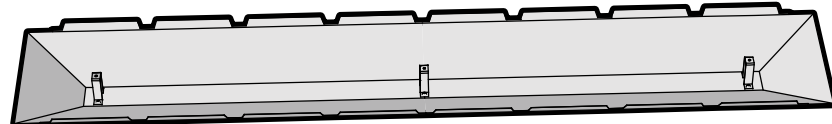

L × 4

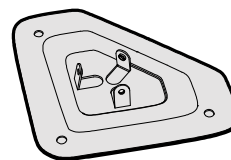

M × 4



N × 4



N1 × 4



P × 2

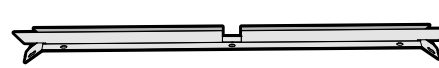

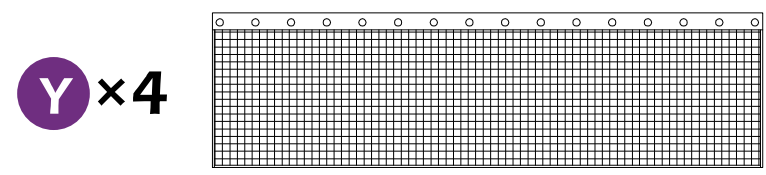
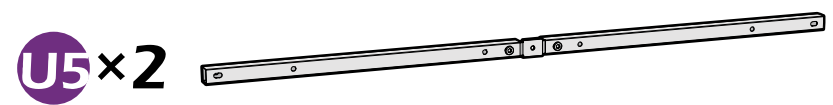
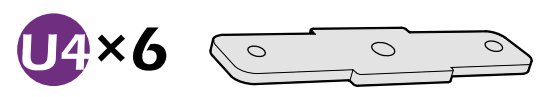
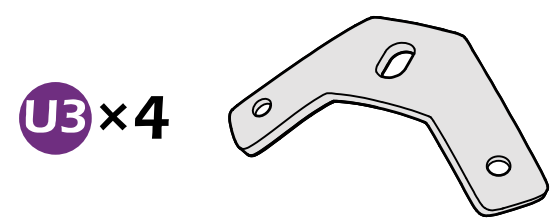
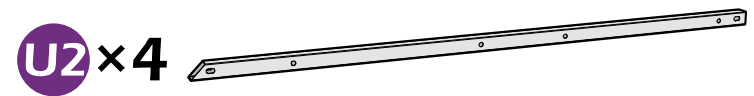
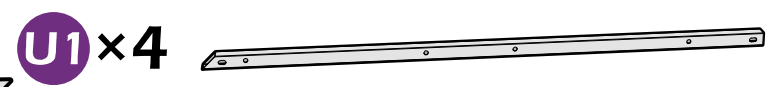
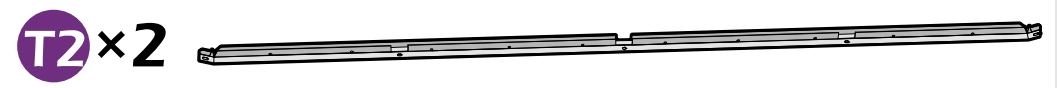
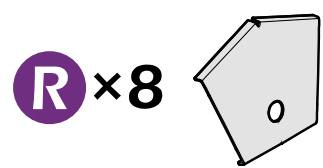
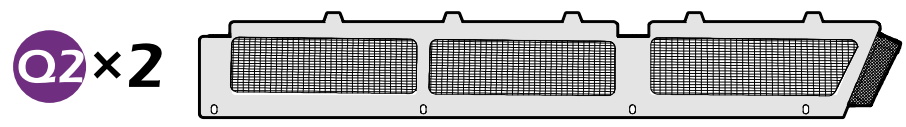
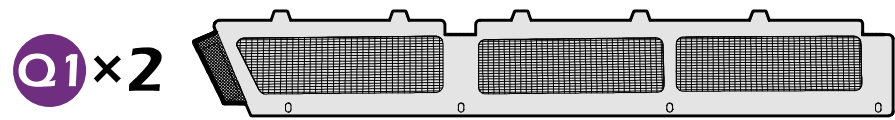
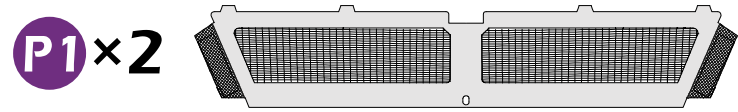

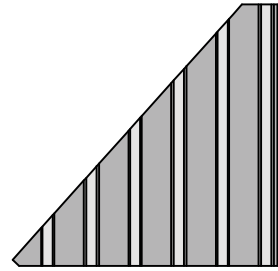

V1×2

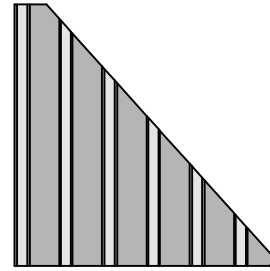

V2×2

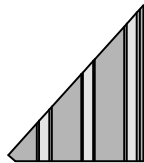

V3×2

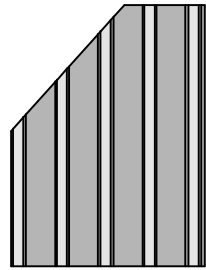

V4×2

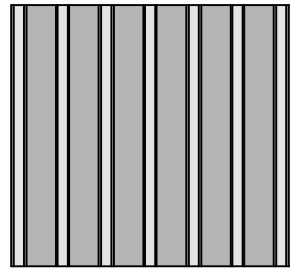

V×4

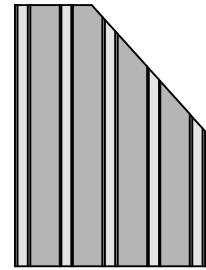

V5×2

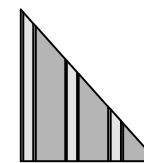

V6×2



W1×2

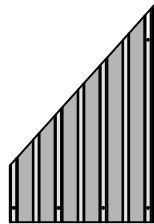

W2×2

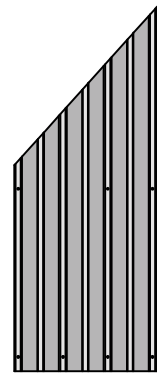

W3×2

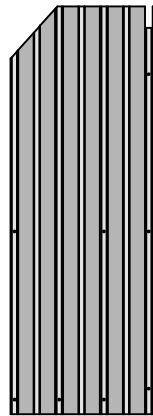

W4×2

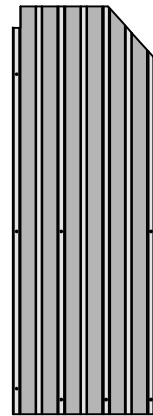

W5×2

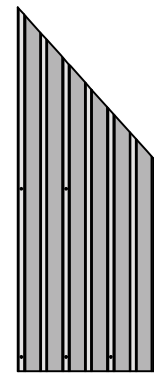

W6×2

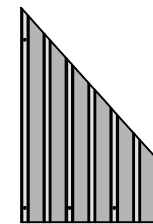

W7×2



W8×2

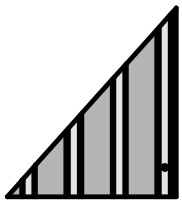

X1 × 2

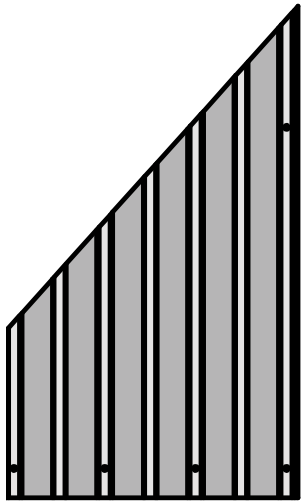

X2 × 2

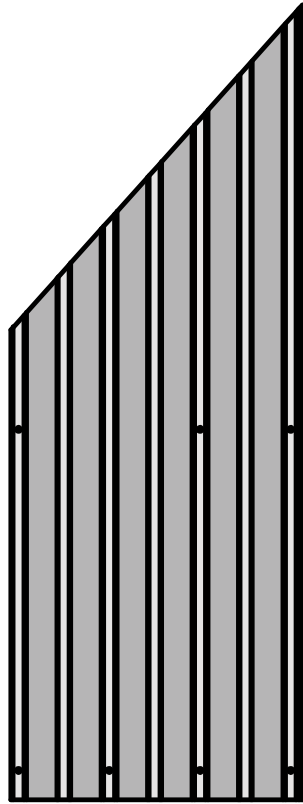

X3 × 2

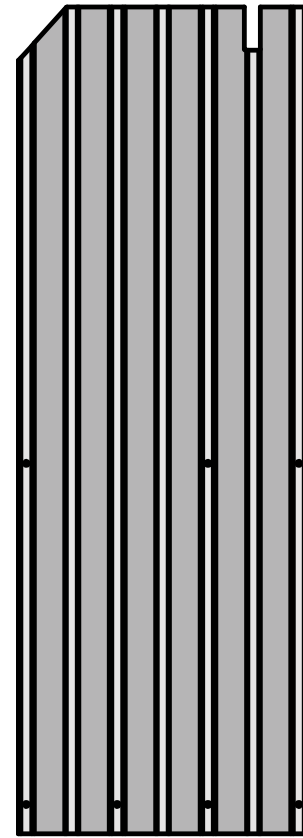

X4 × 2

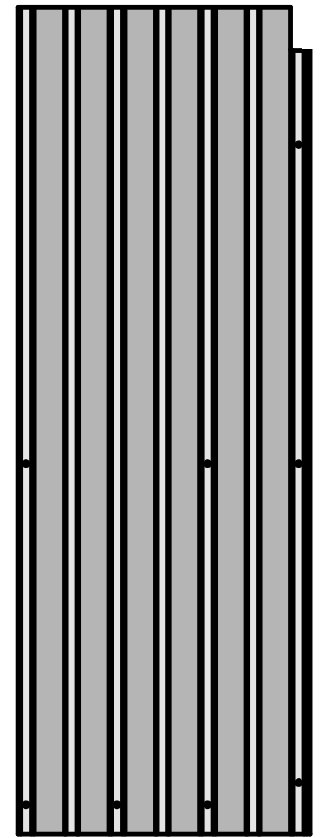

X5 × 2

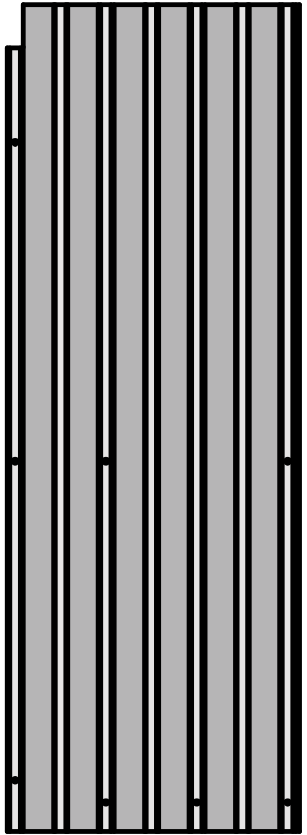

X6 × 2

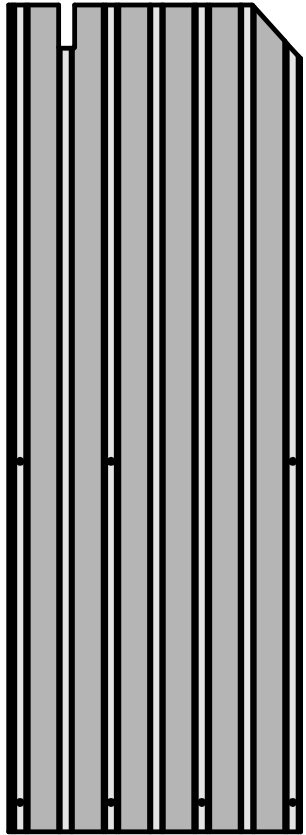

X7 × 2

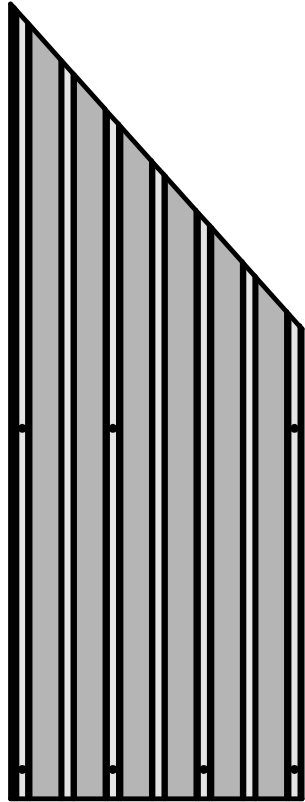

X8 × 2

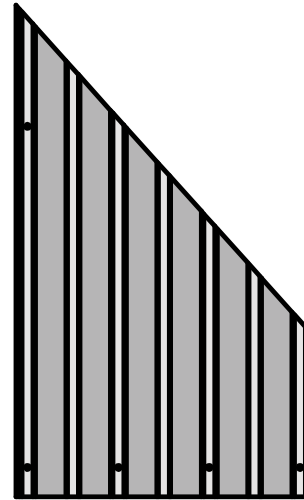

X9 × 2

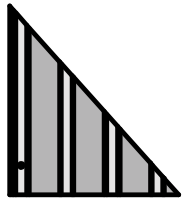

X10 × 2

Z×72



Z1×4



Z2×4



Z3×4



Z4×4



1#×259

(M6×16)

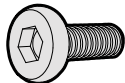

2#×16

(M6×20)

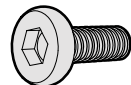

3#×16

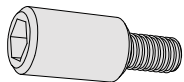

4#×64

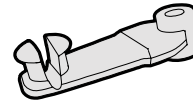

5#×84

(M6×28)

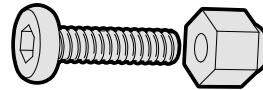

6#×8

(M6×45)

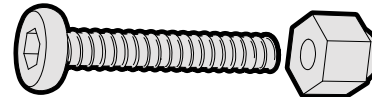

7#×40

(M6×50)

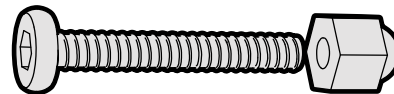

8#×4

(M5×16)

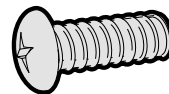

9#×24

(ST4.8×13)

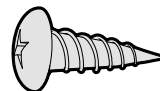

10#×4

(M6×25)

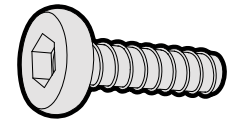

11#×12

(M6×10)

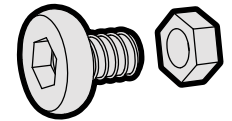

12#×1

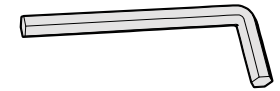

13#×1



14#×1

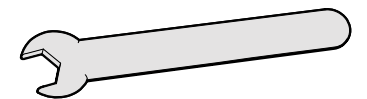

15#×1

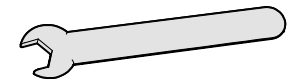



STEP 1

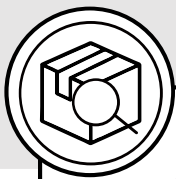

A × 4



L × 4

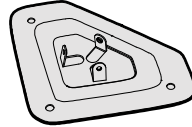

1# × 12

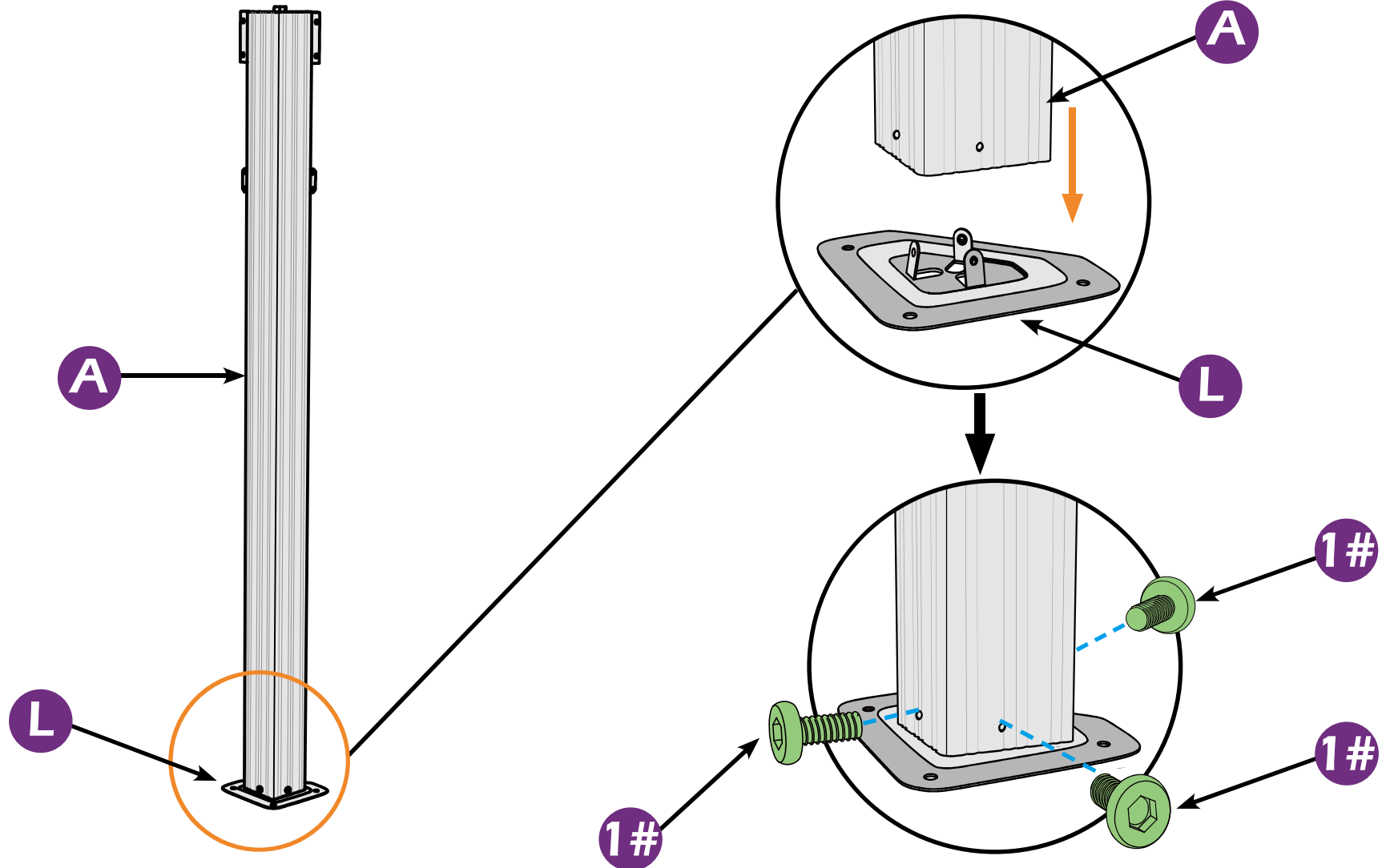
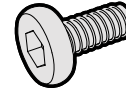

STEP 1

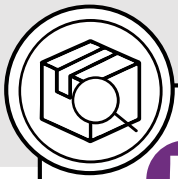

B × 2

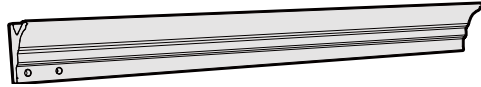

F × 2

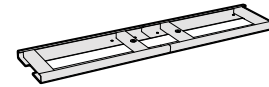

C × 2

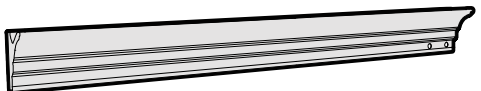

1# × 8

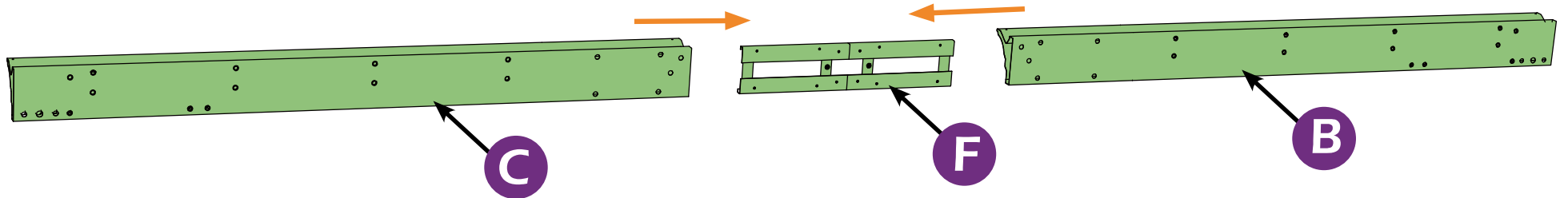
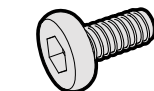

STEP 1

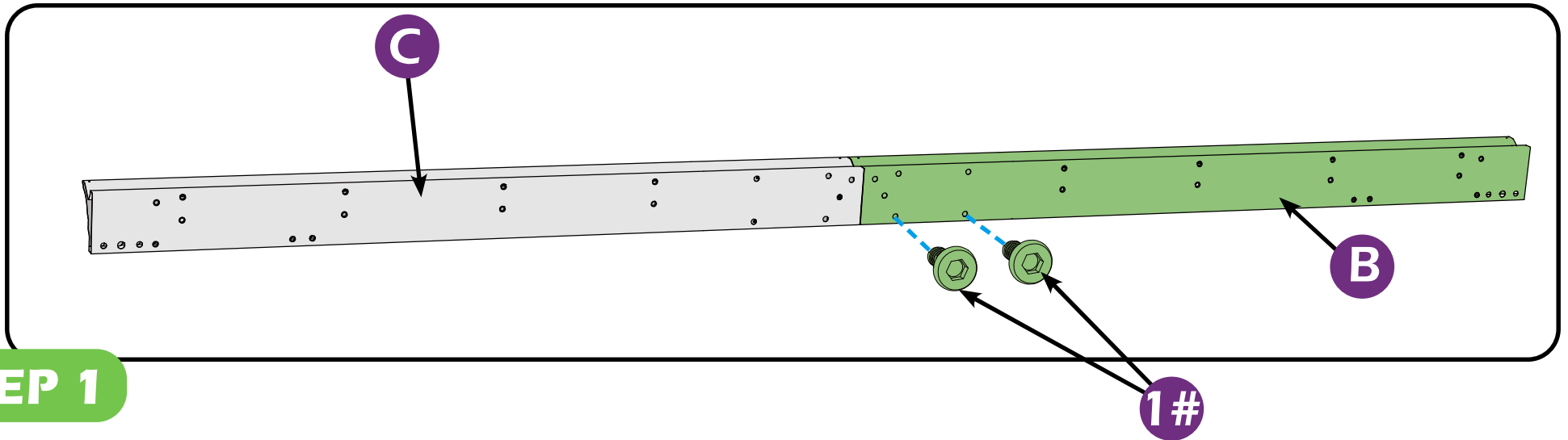
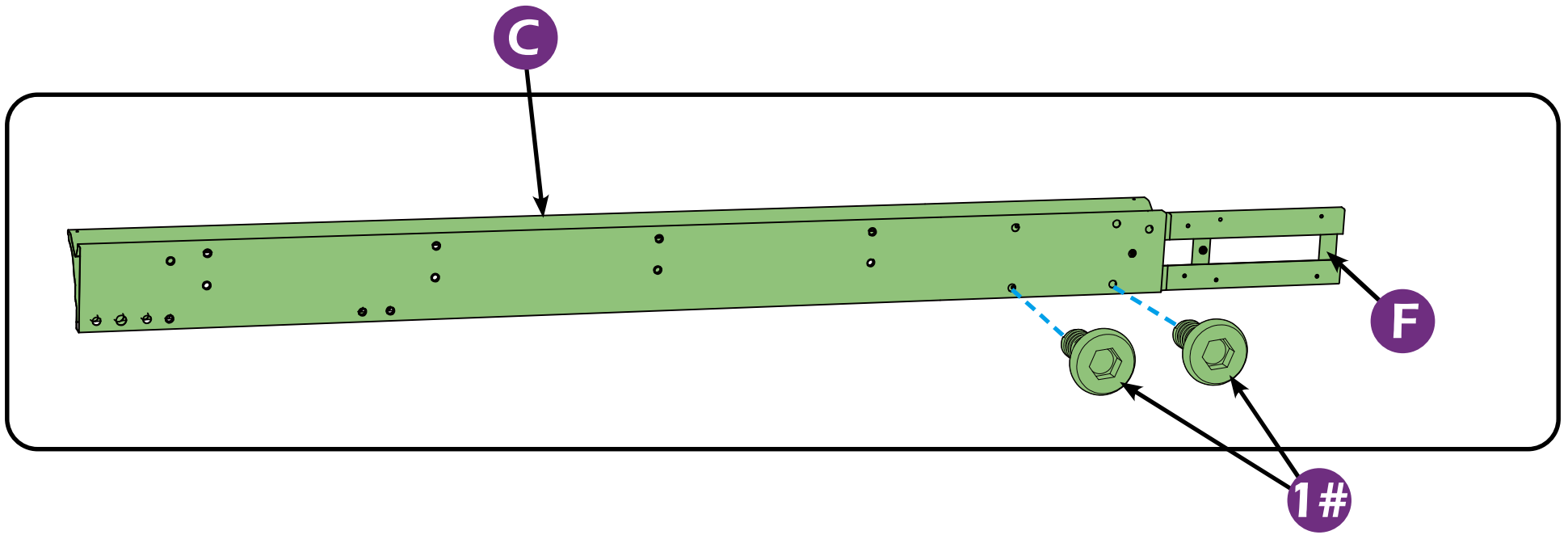

STEP 1

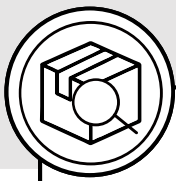

C1 × 2



1# × 24

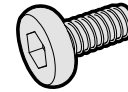

B1 × 2

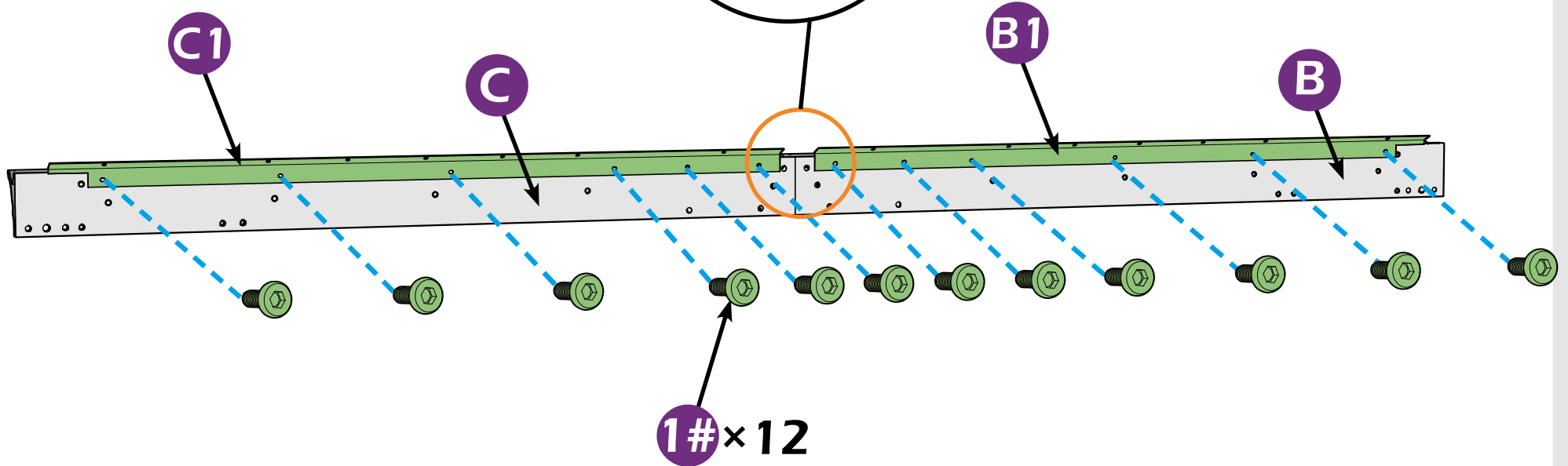
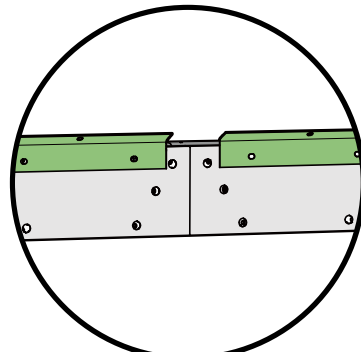

STEP 1



D × 2



F × 2

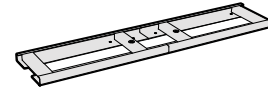

E × 2

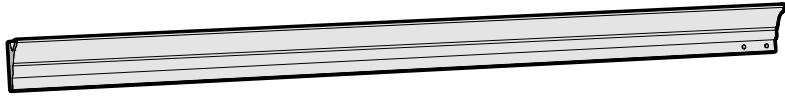

1# × 8

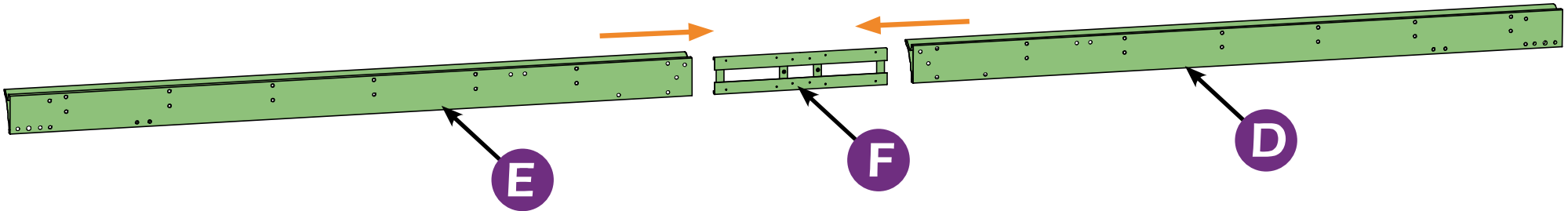
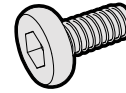

STEP 1

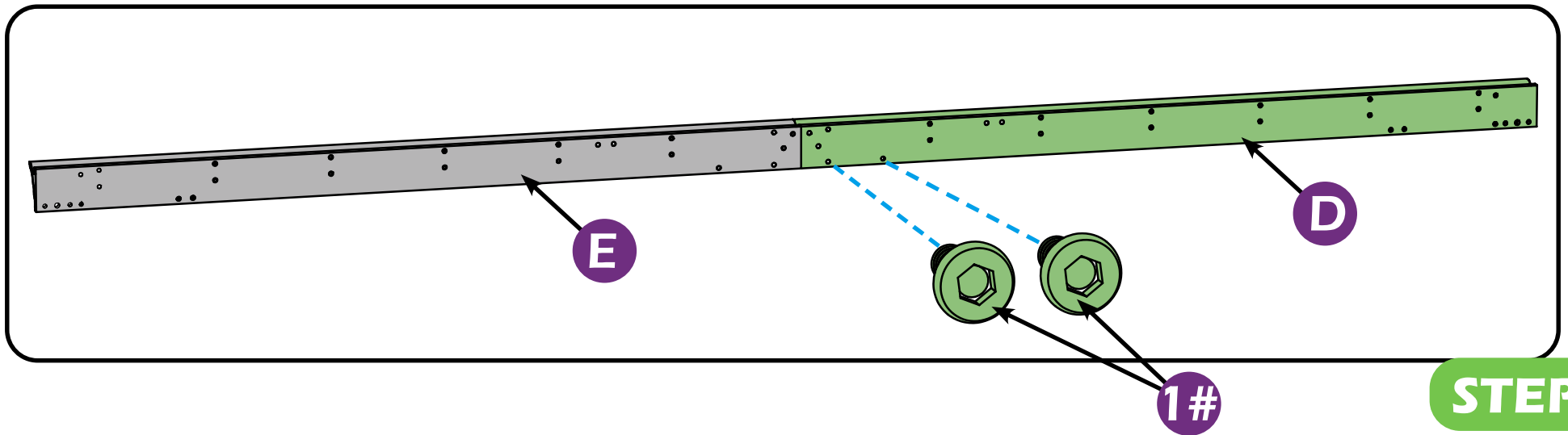
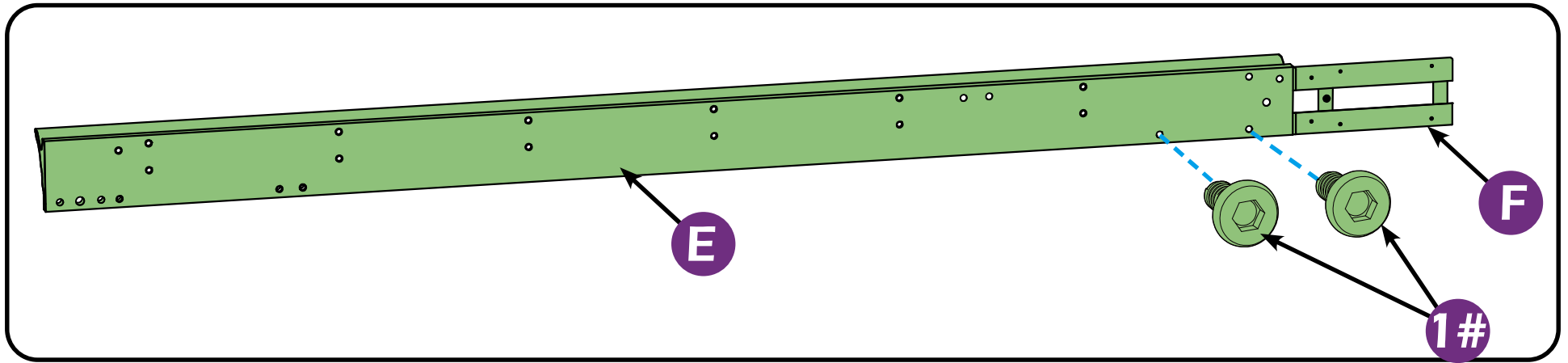

STEP 1

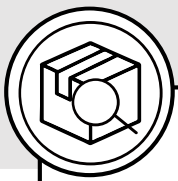

D1×2

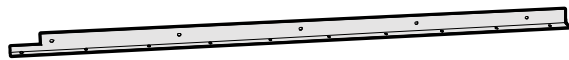

D1a×2



1#×32

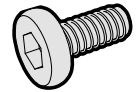

E1×2

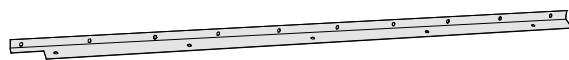

E1a×2

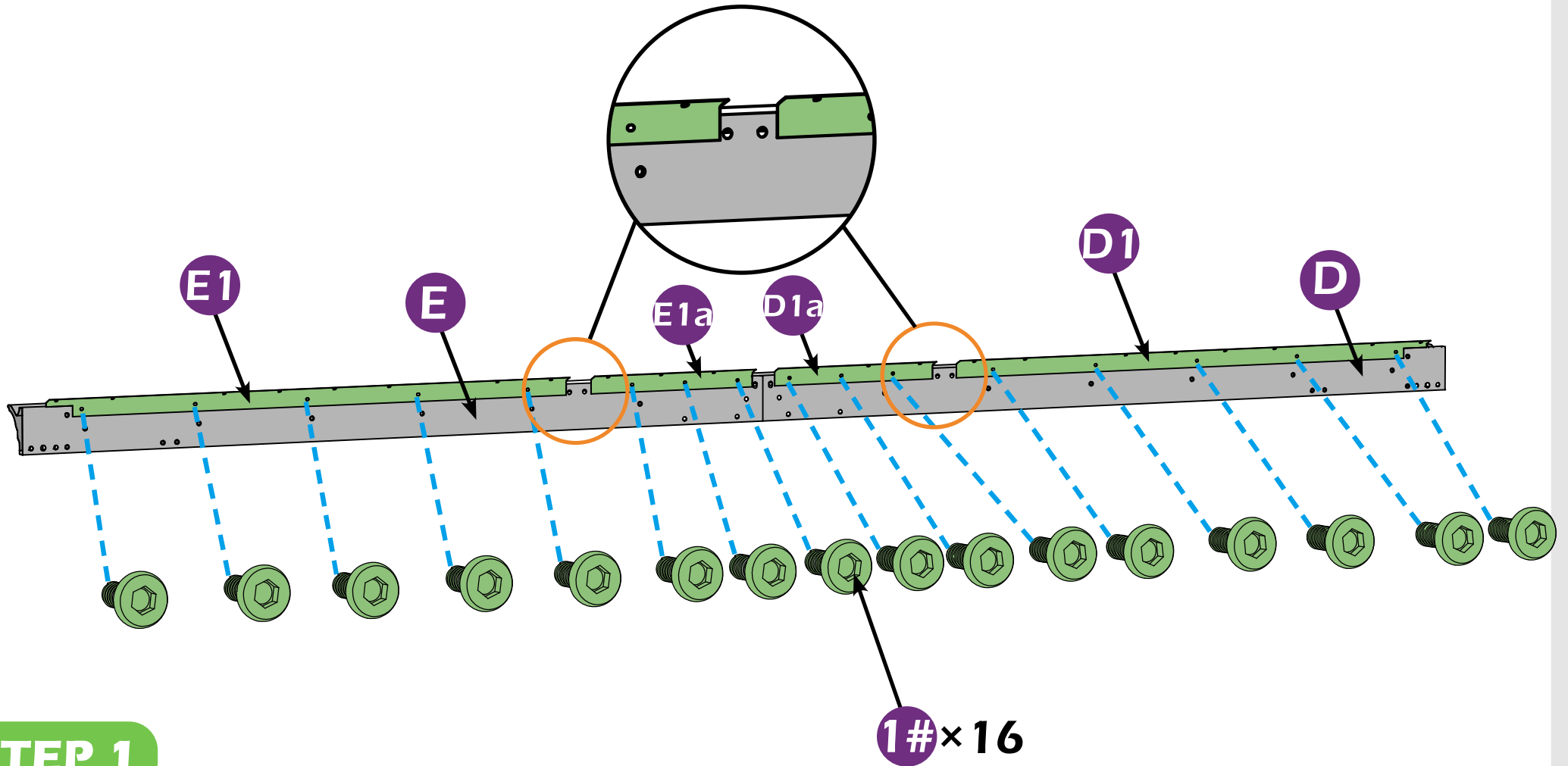

STEP 1

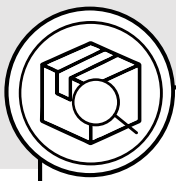

2# × 16

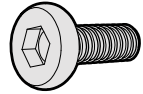

3# × 16

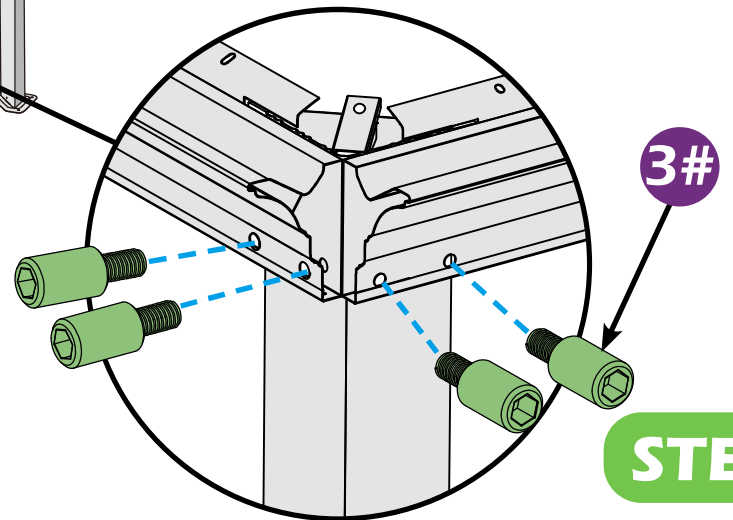
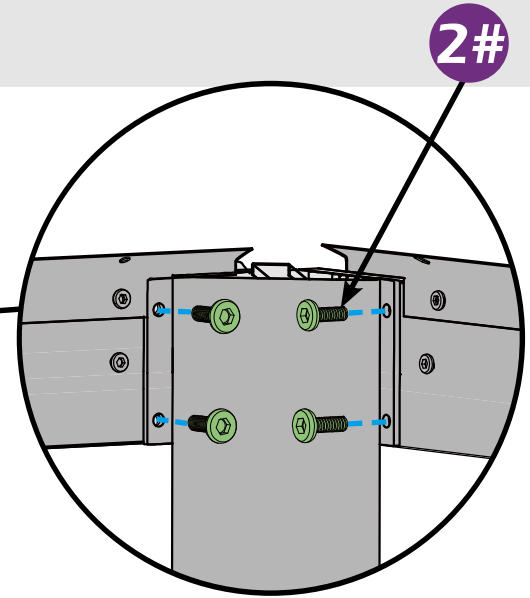
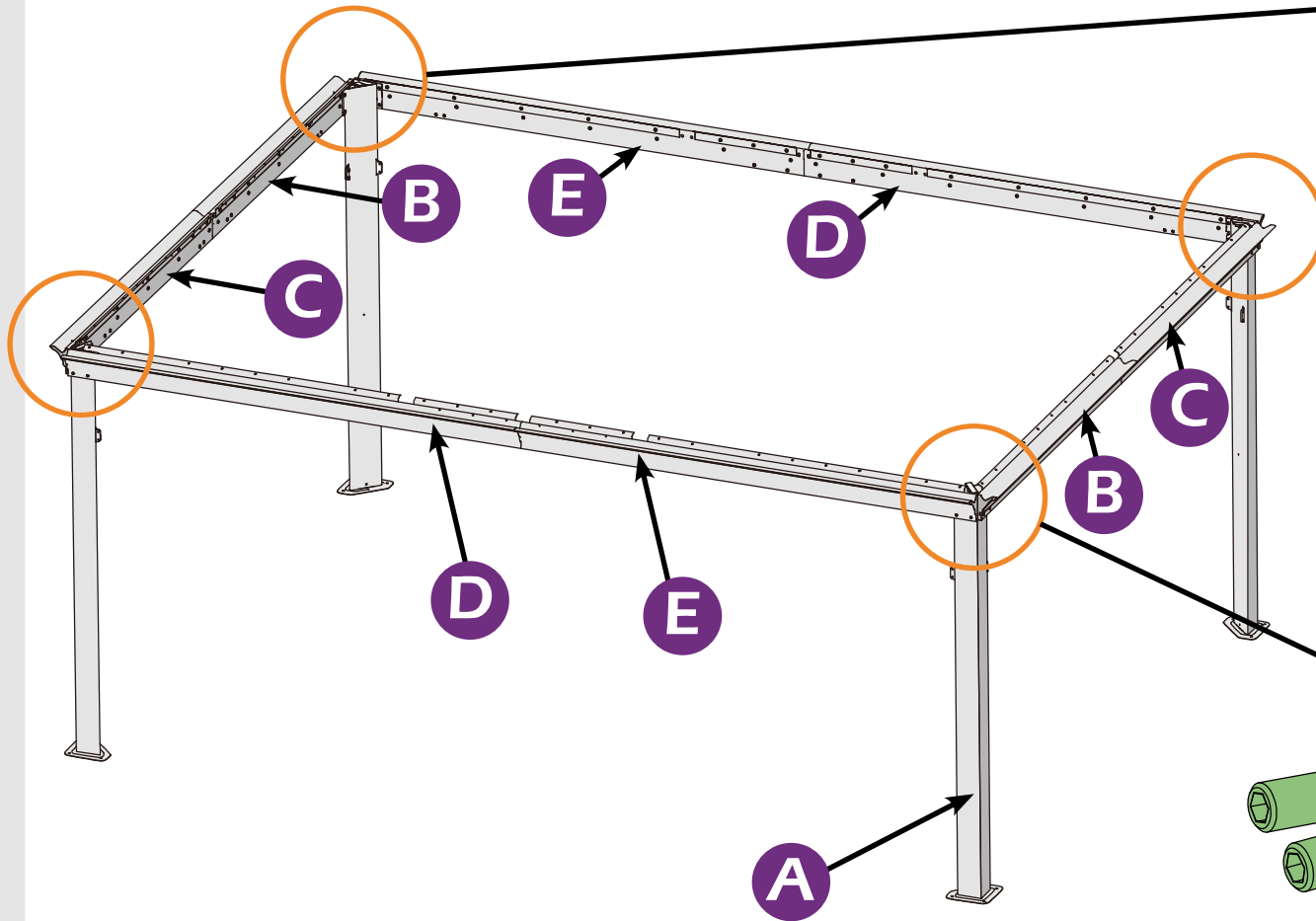
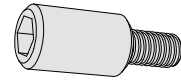

STEP 1

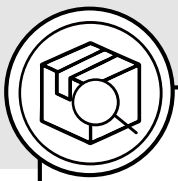

J1 × 4



1# × 32

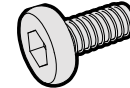

J2 × 4

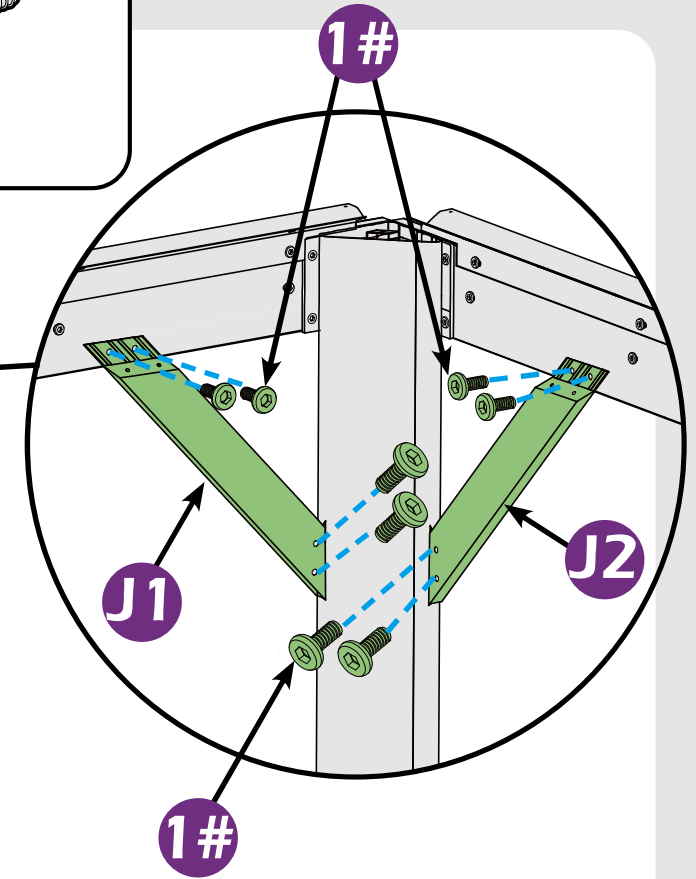
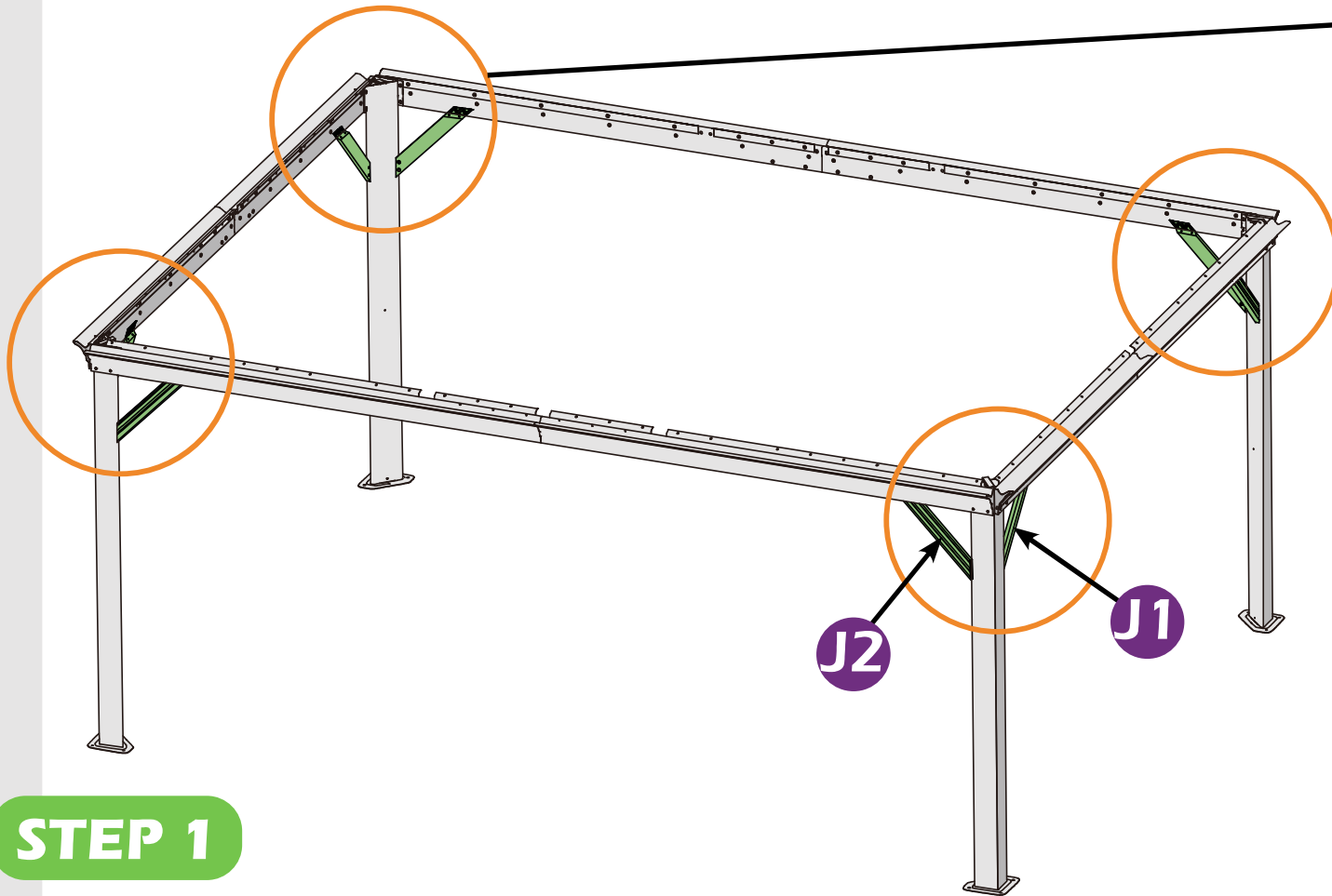

STEP 1

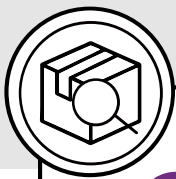

G × 4

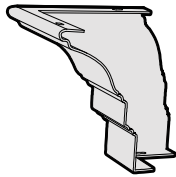

9# × 16

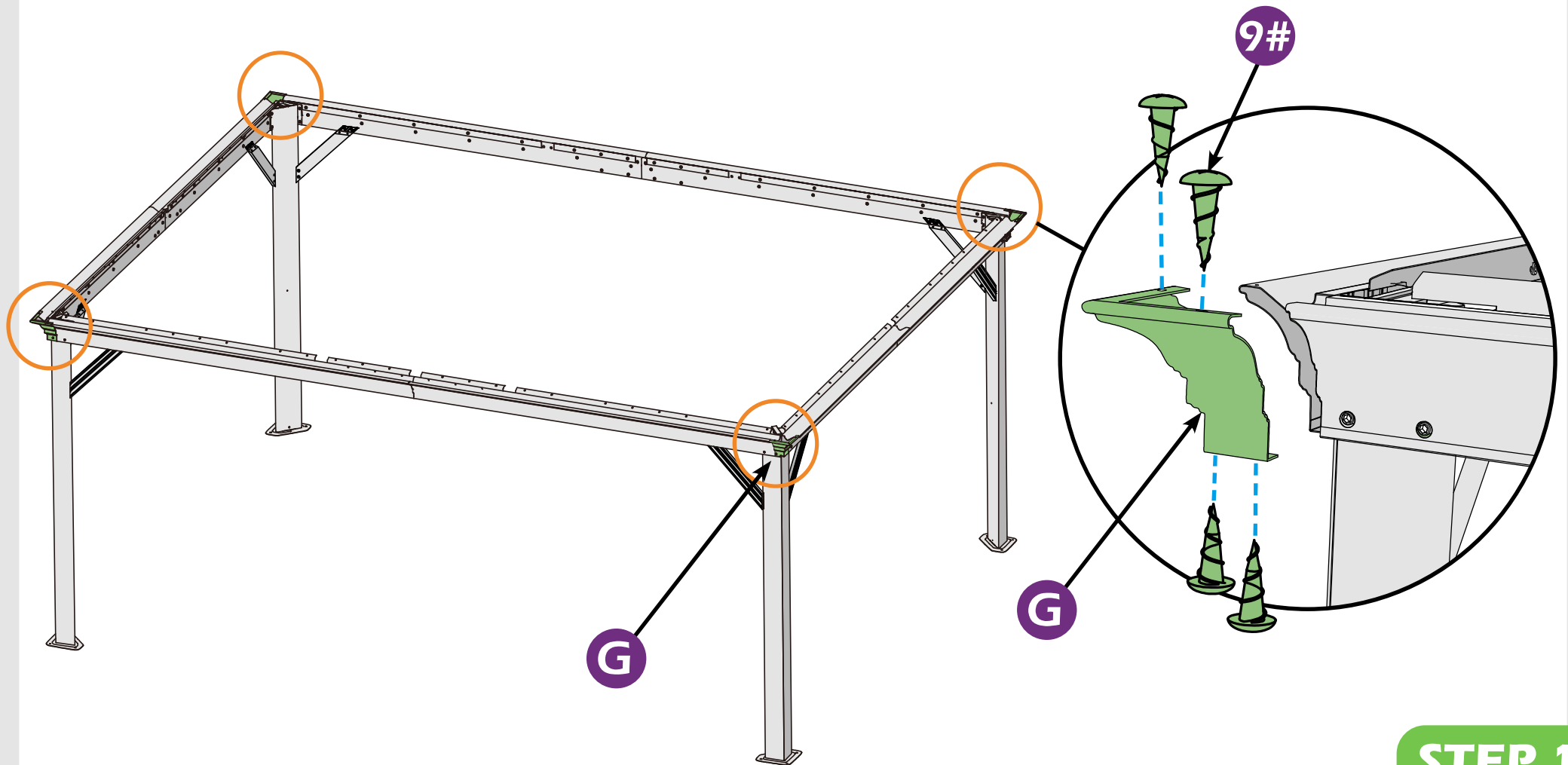
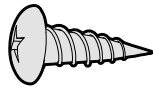

STEP 1

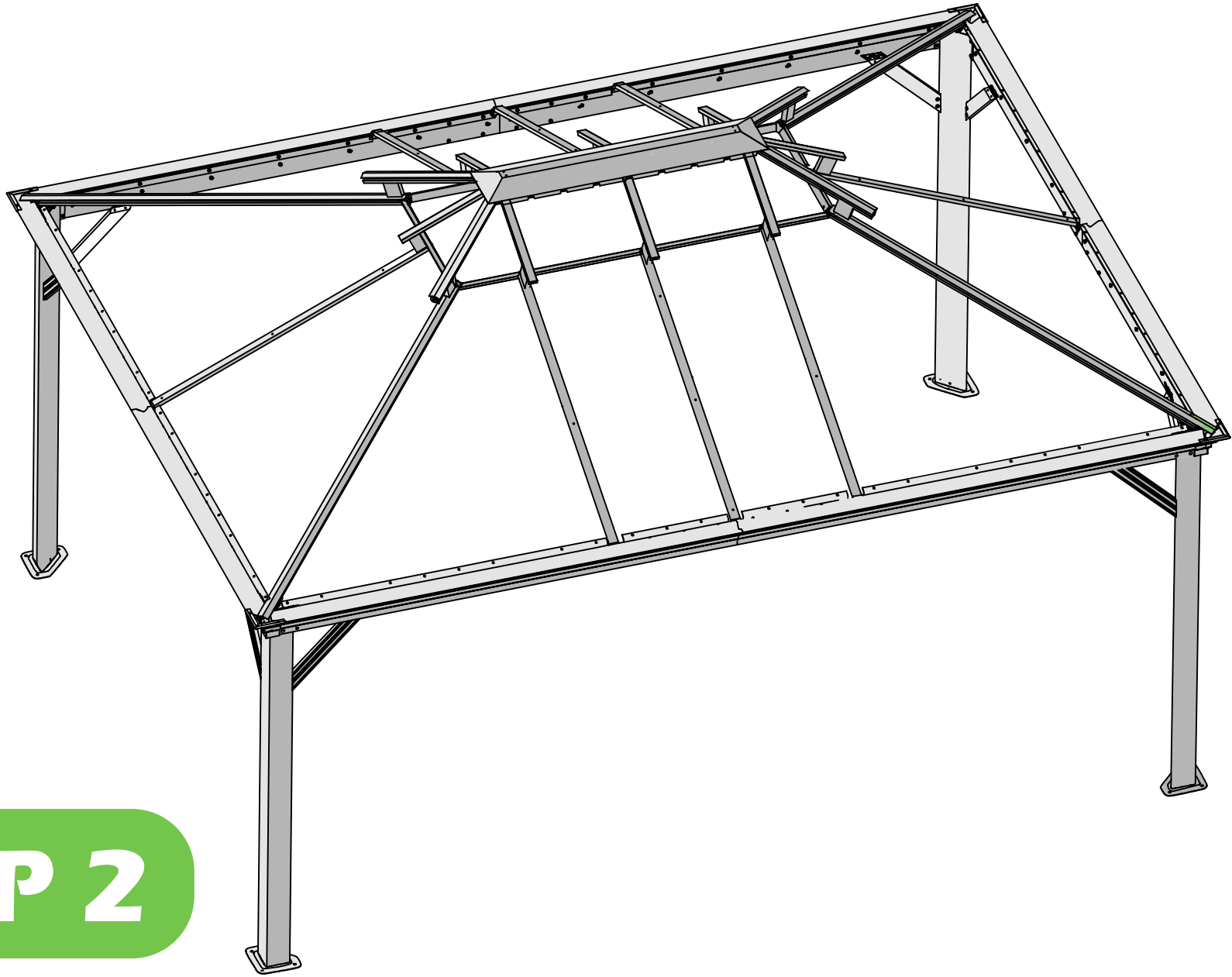

STEP 2

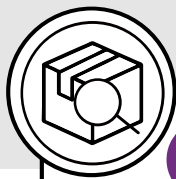

K × 1

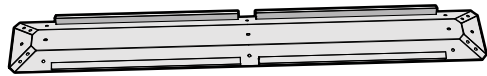

K1 × 1

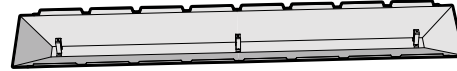

1# × 3

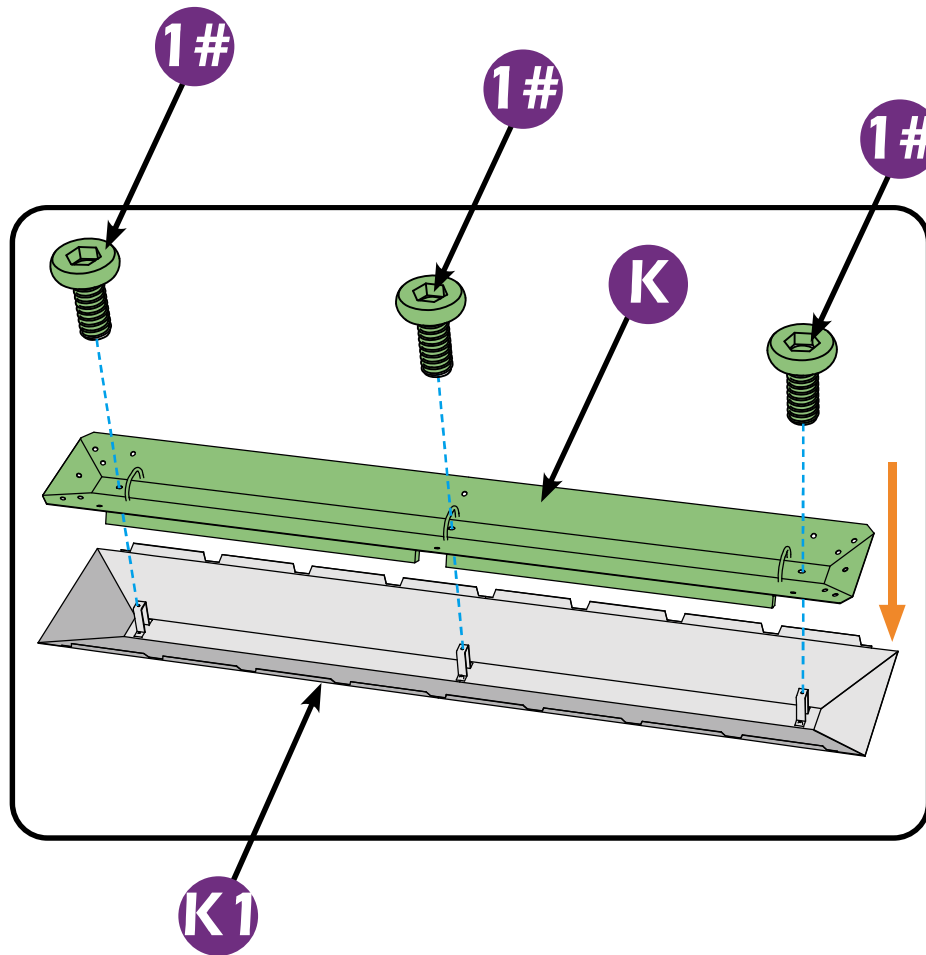
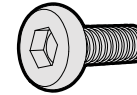

Don't fully tighten the screw **1#**, It might cause problem on roofs installation.

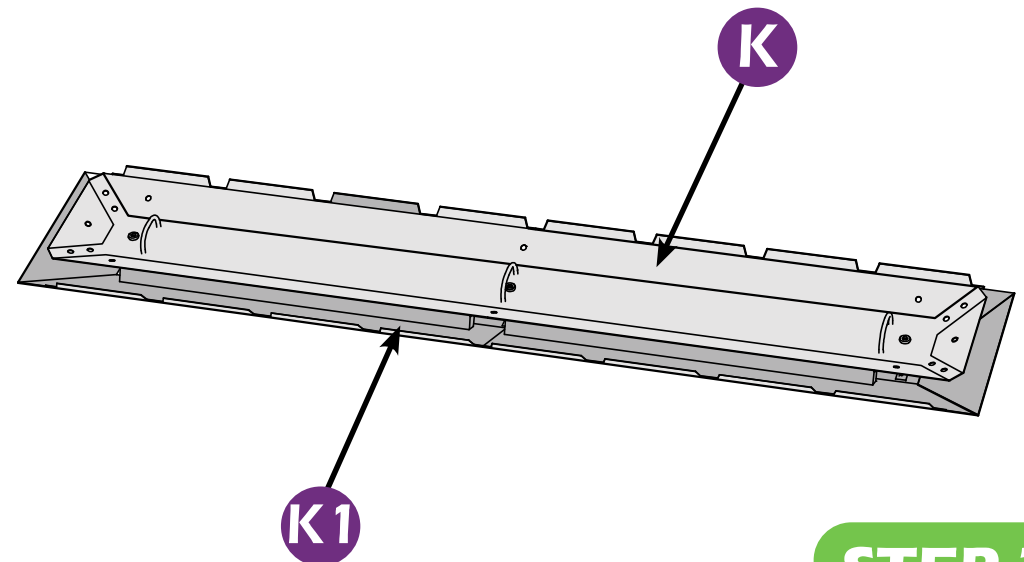

STEP 2

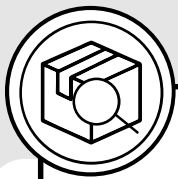

M × 1



N × 1



1# × 3

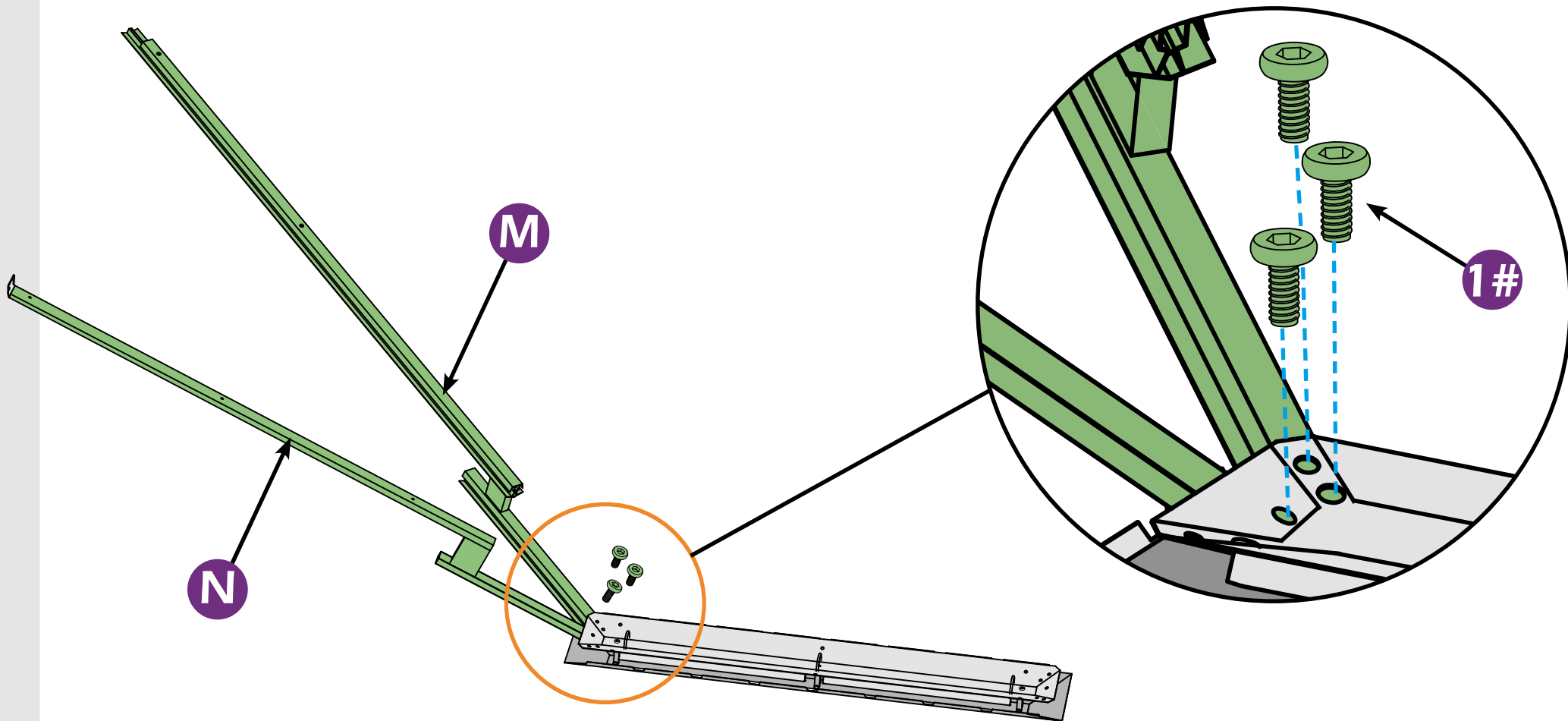
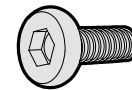

STEP 2

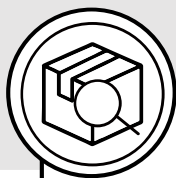

1# x 3

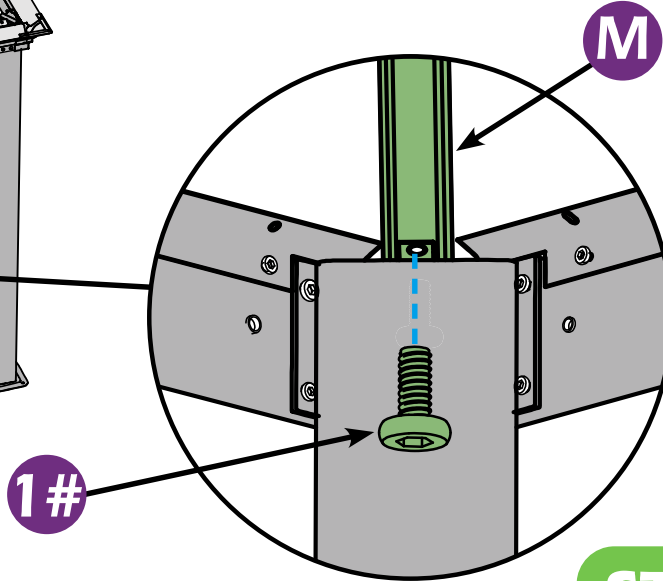
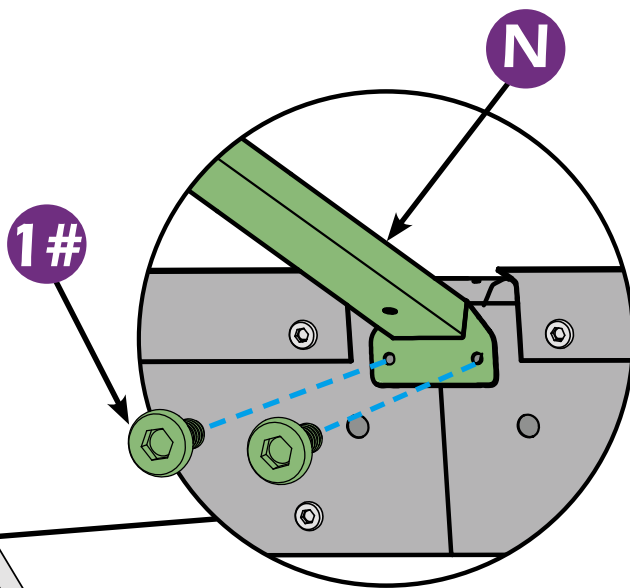
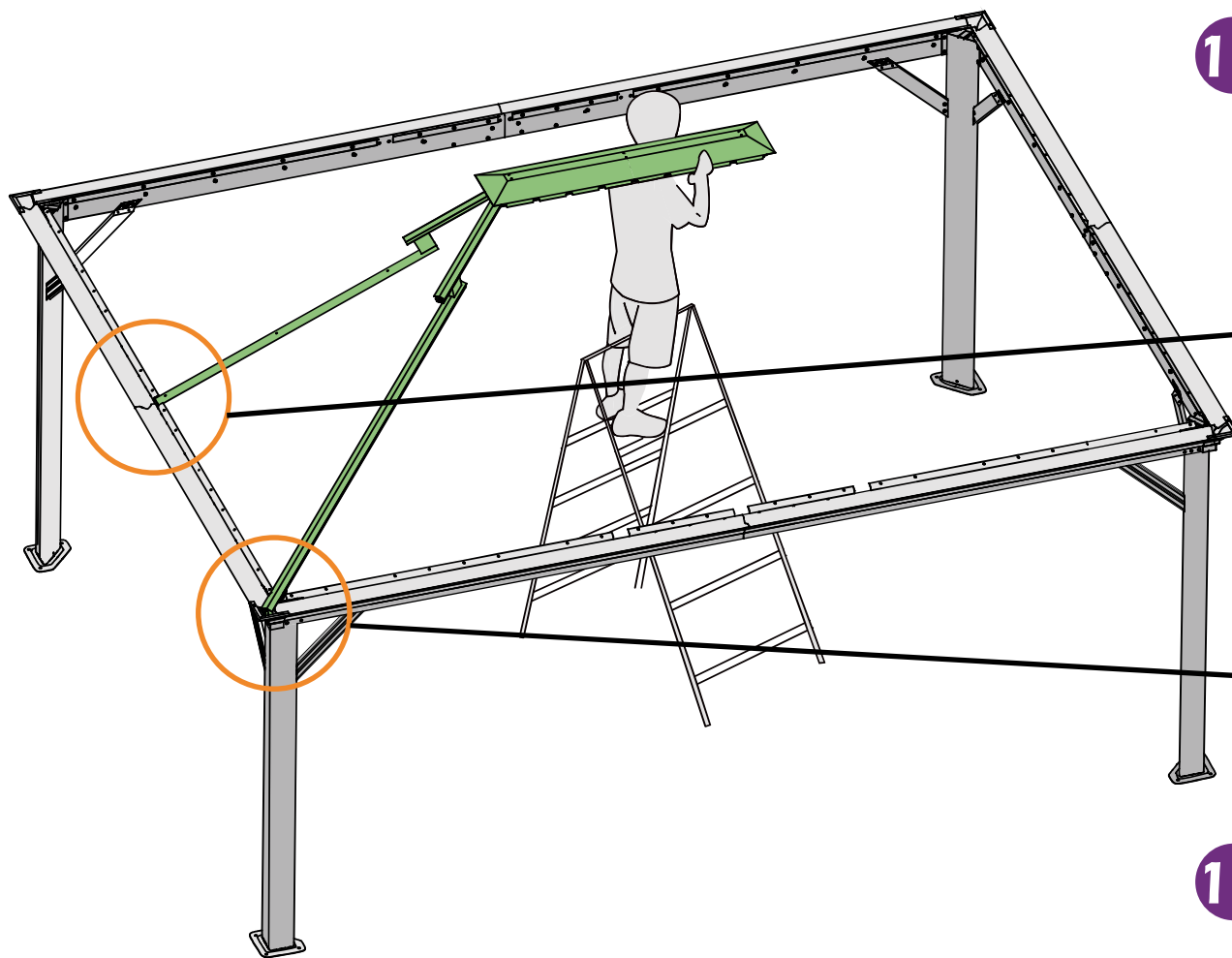
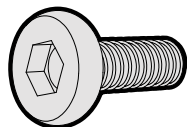

STEP 2

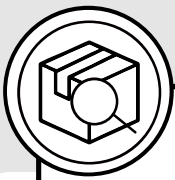

M × 3



1# × 9

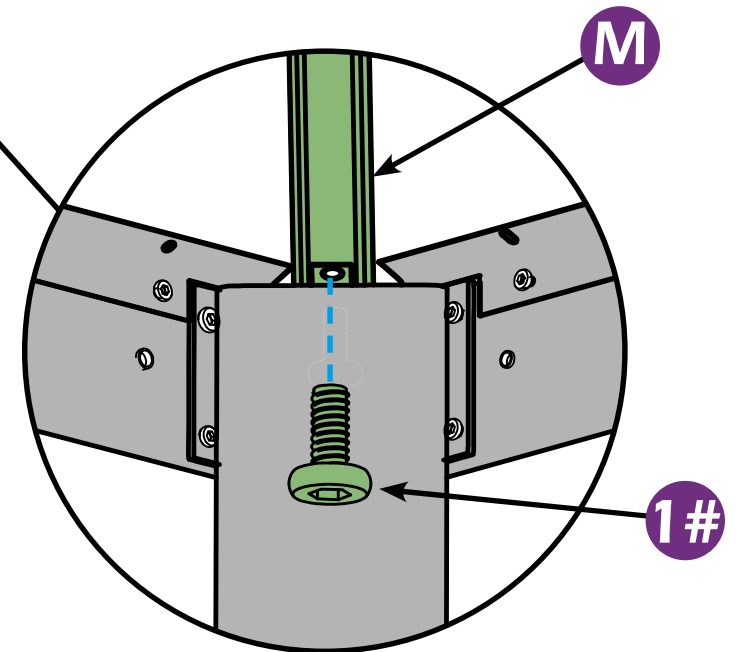
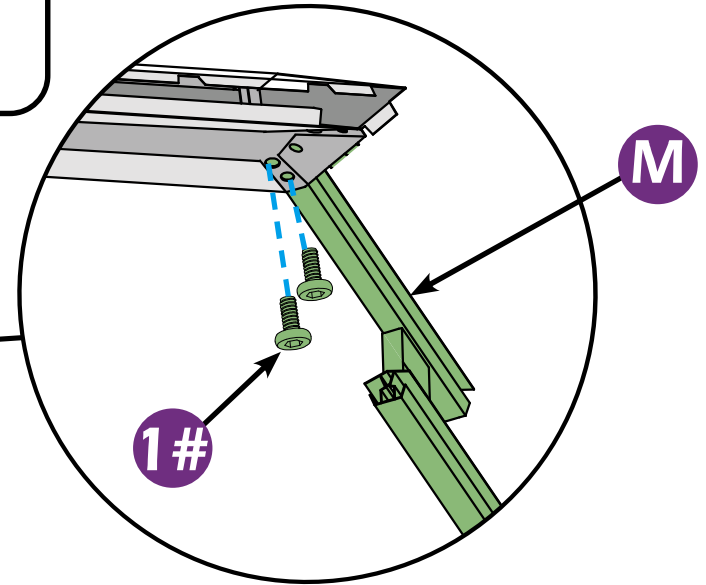
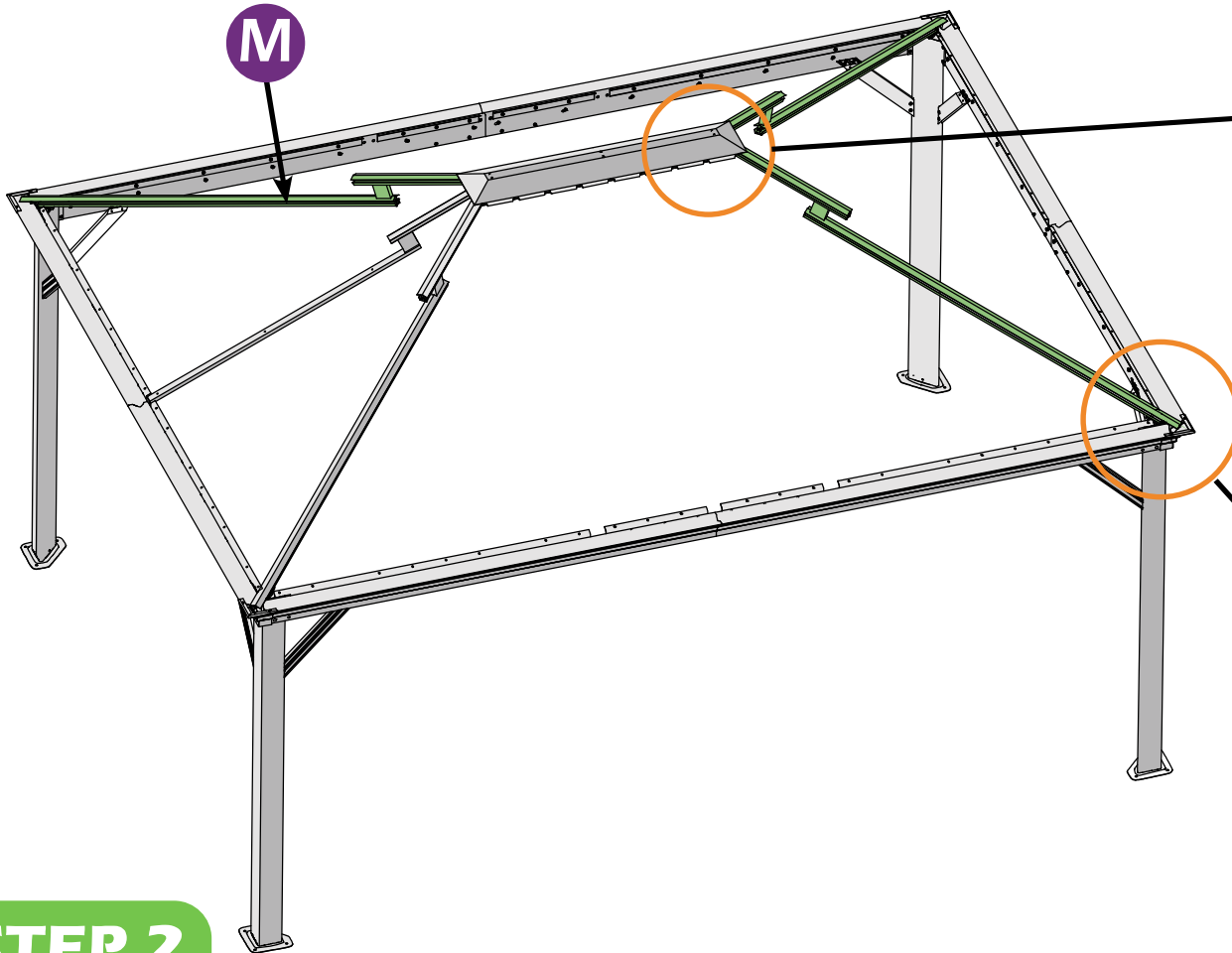
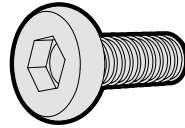

STEP 2

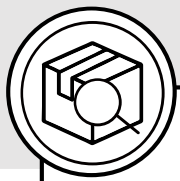

N × 1



1# × 3

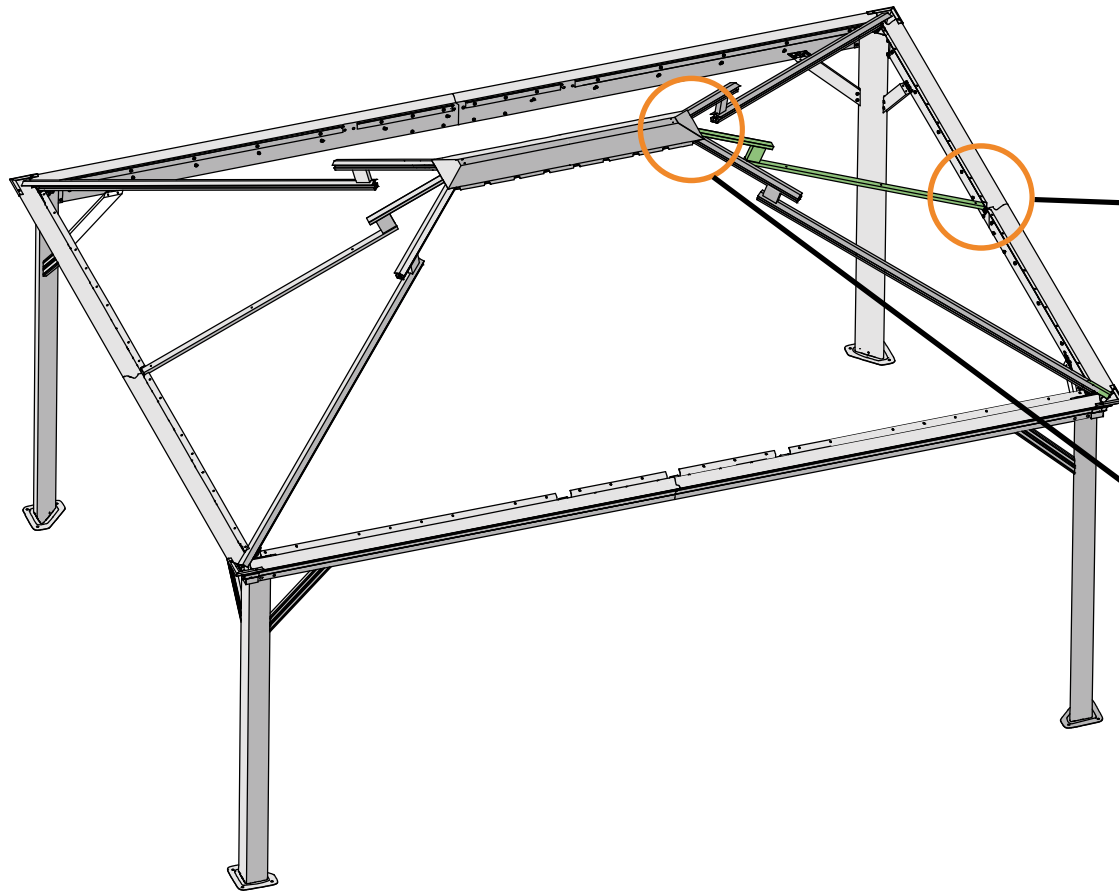
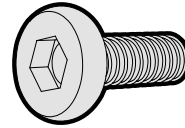

1#

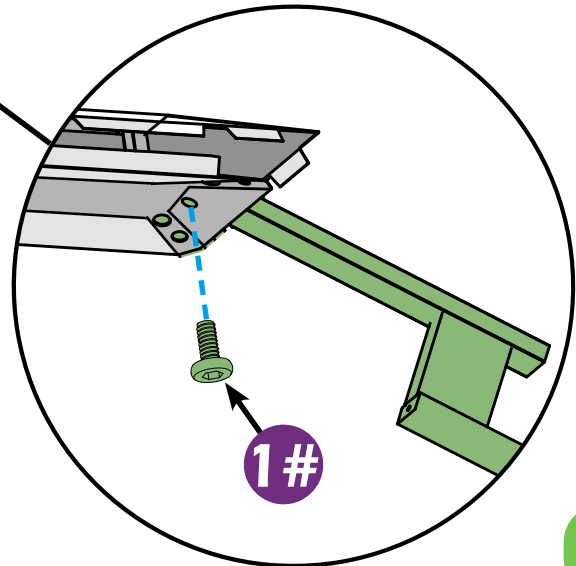
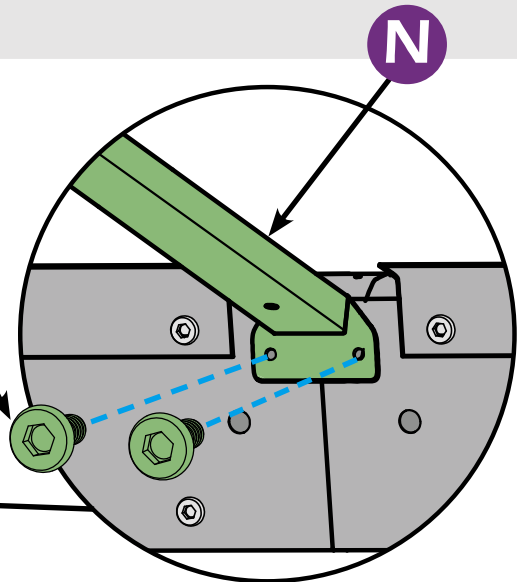

STEP 2

Check the the frame as pictures below shows.

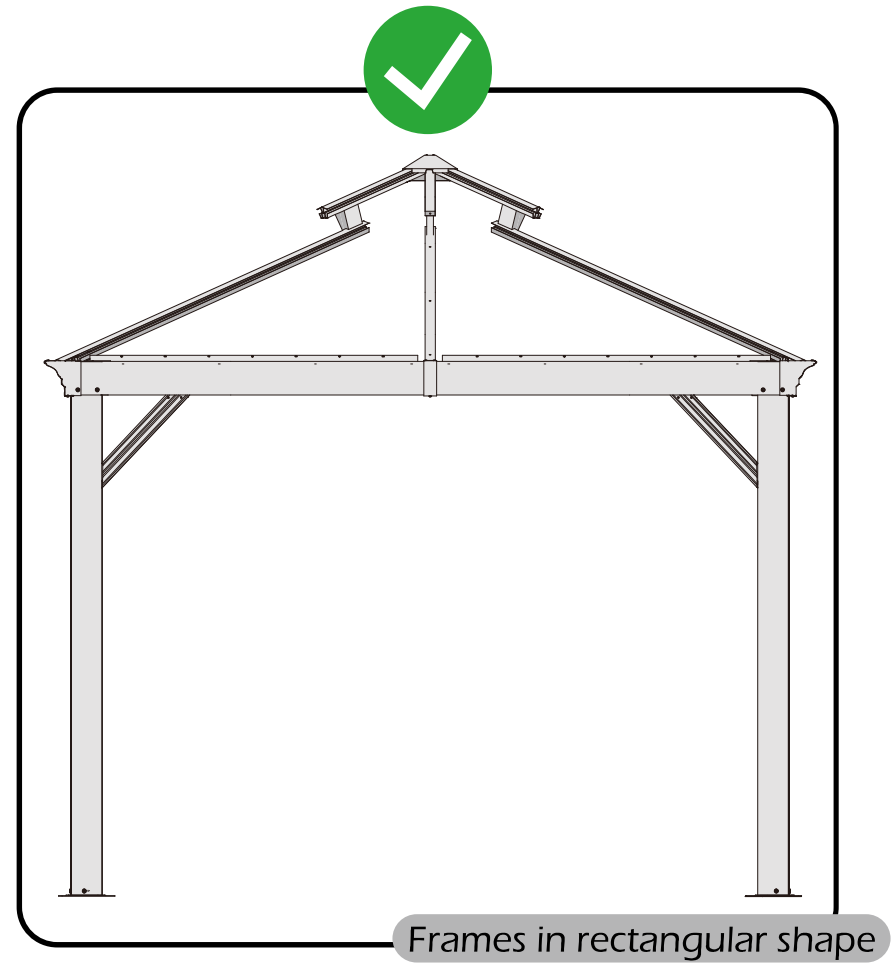
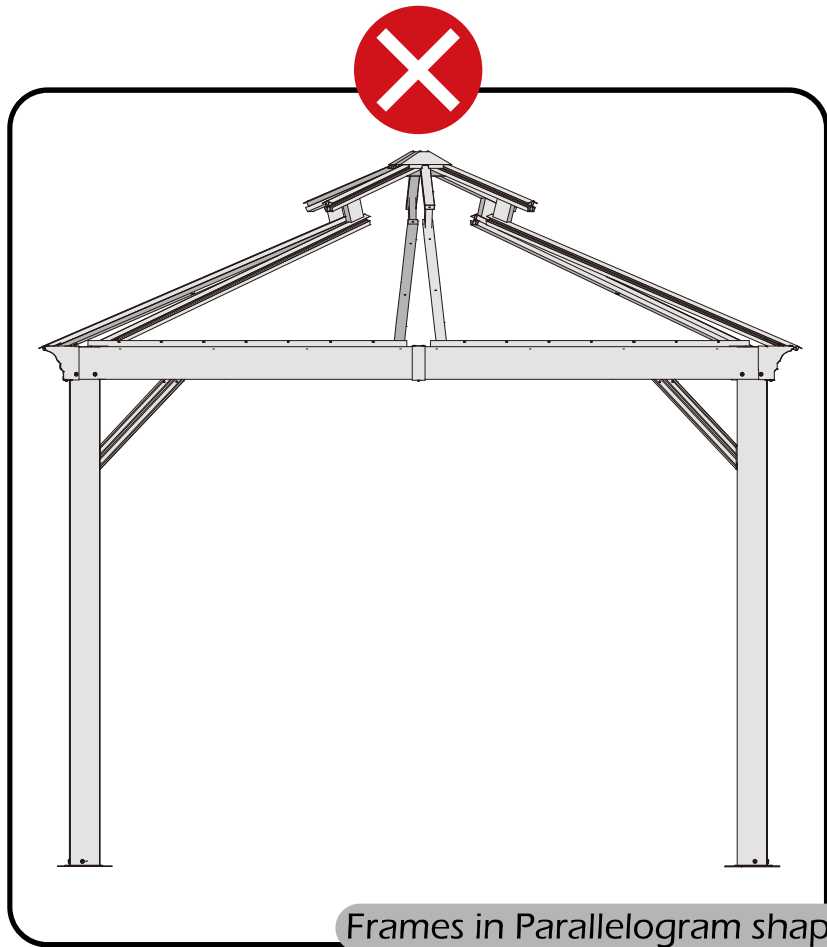

STEP 2

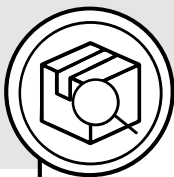

N × 2

N1 × 4

1# × 18

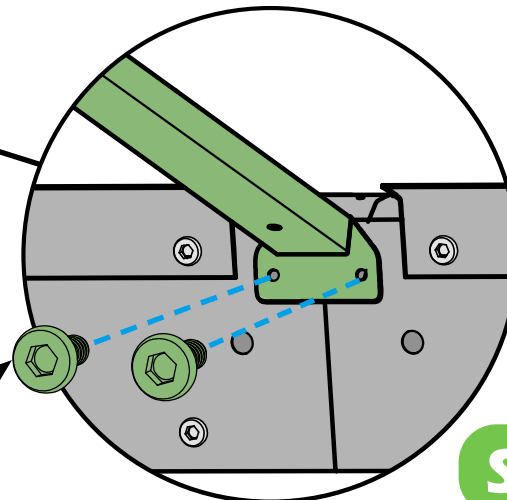
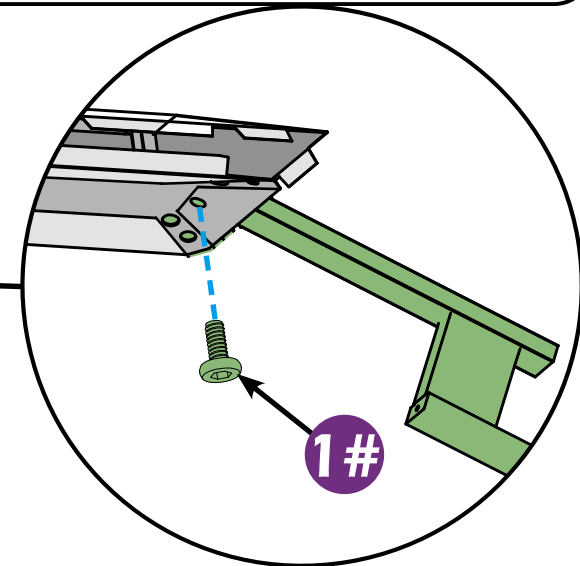
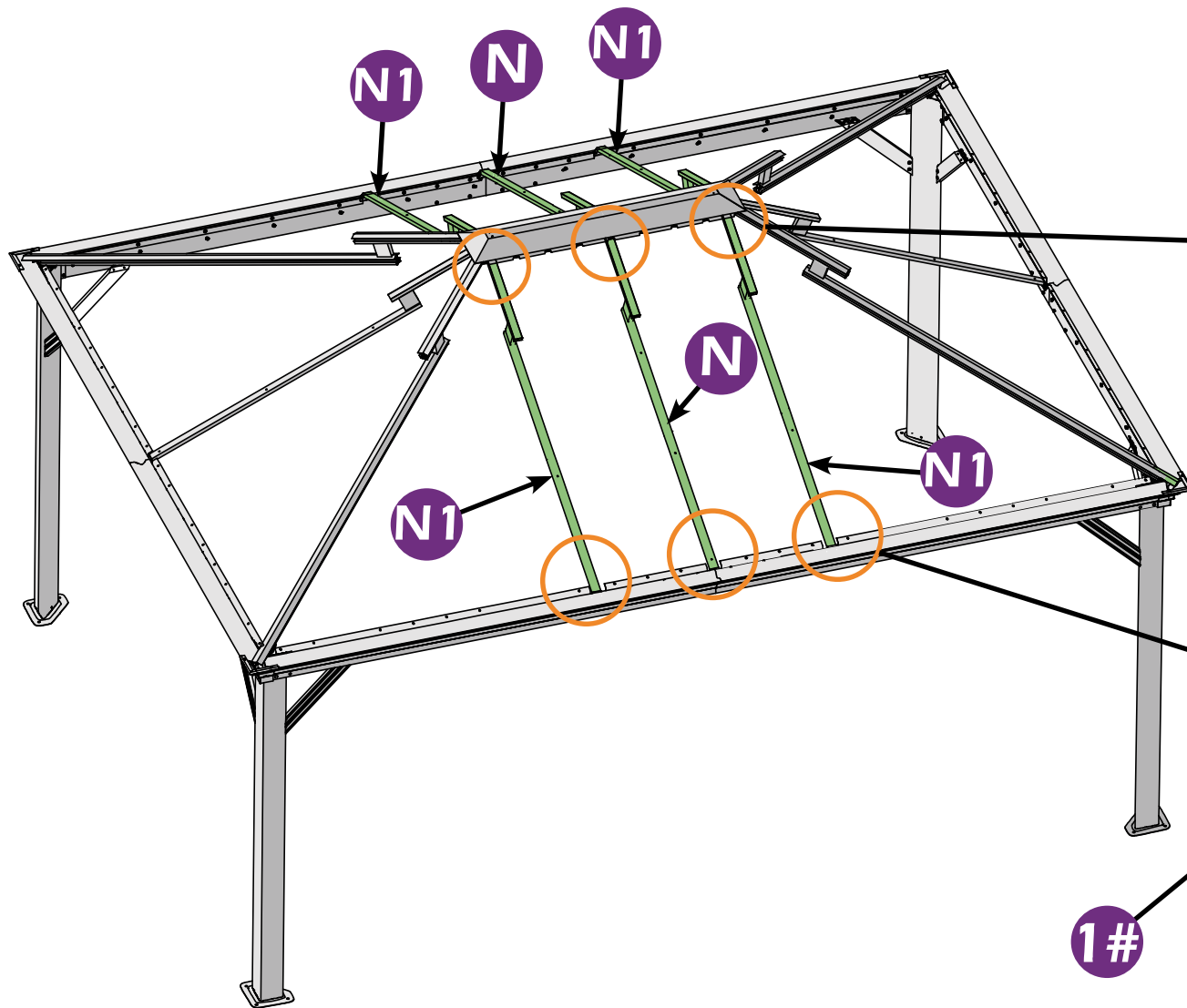
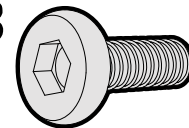

STEP 2

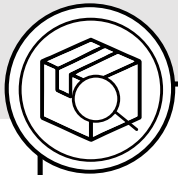

P × 2

R × 4

1# × 12

Q × 2

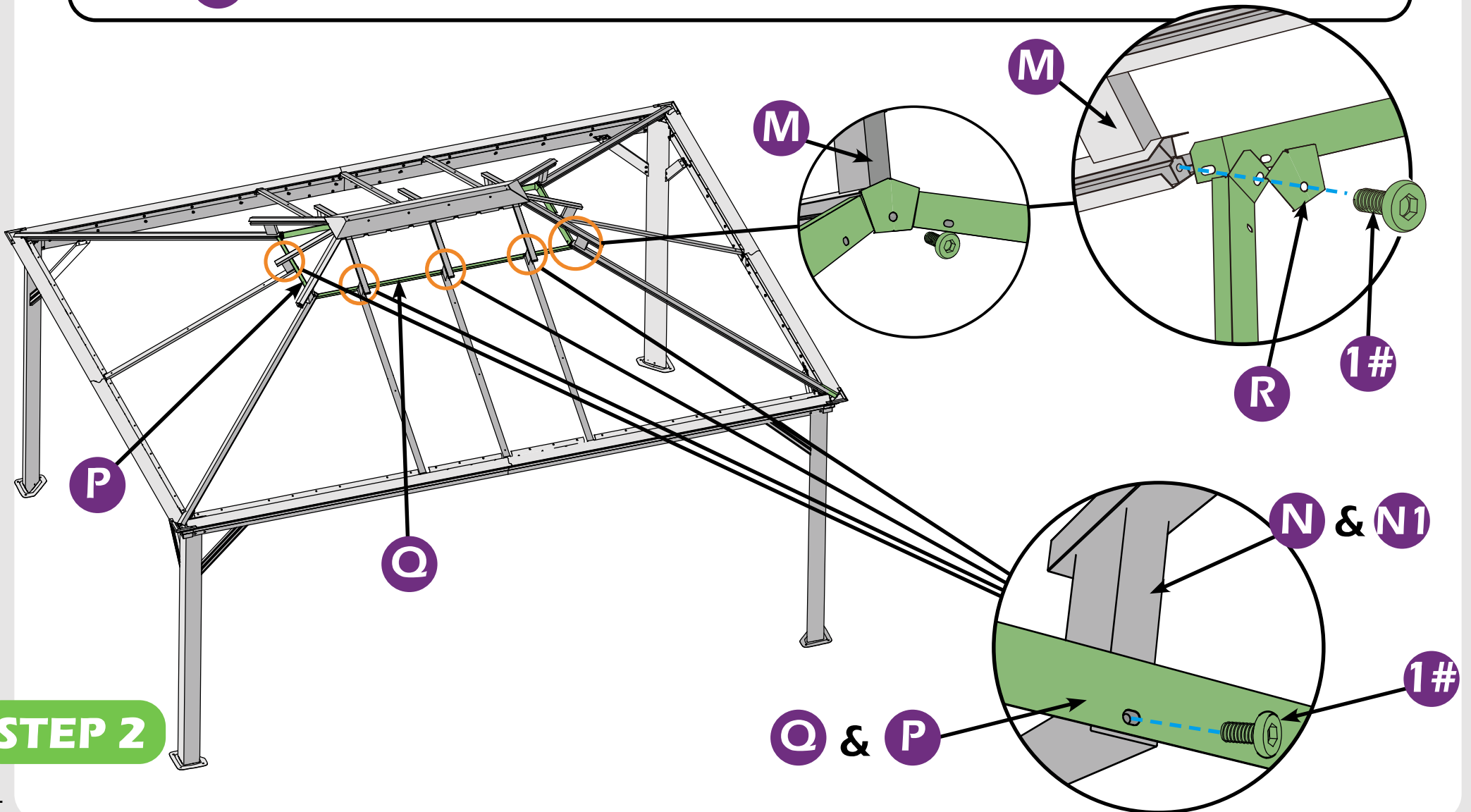

STEP 2

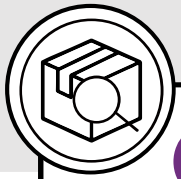

P1 × 2

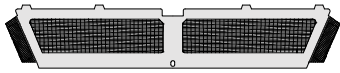

Q1 × 2

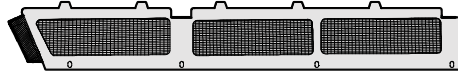

Q2 × 2

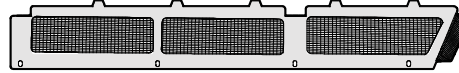

1# × 8

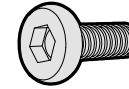

11# × 12

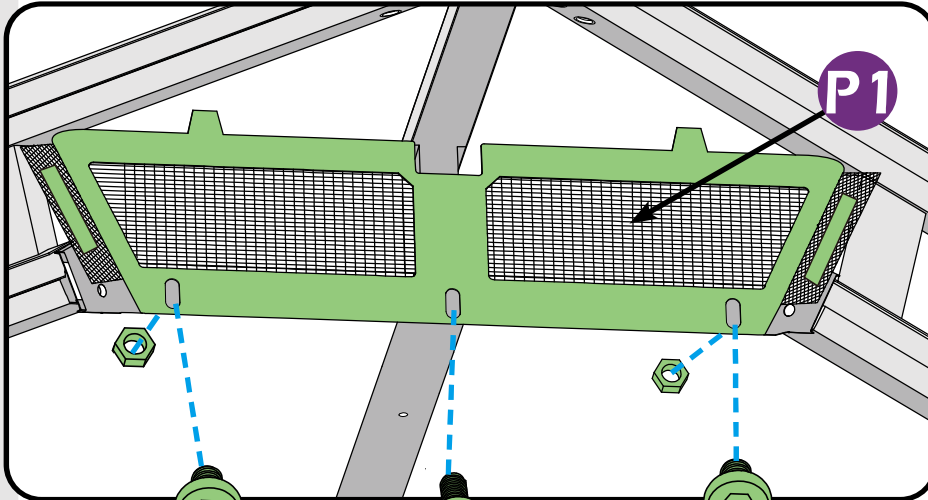
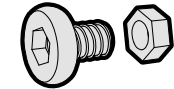

11#

1#

11#

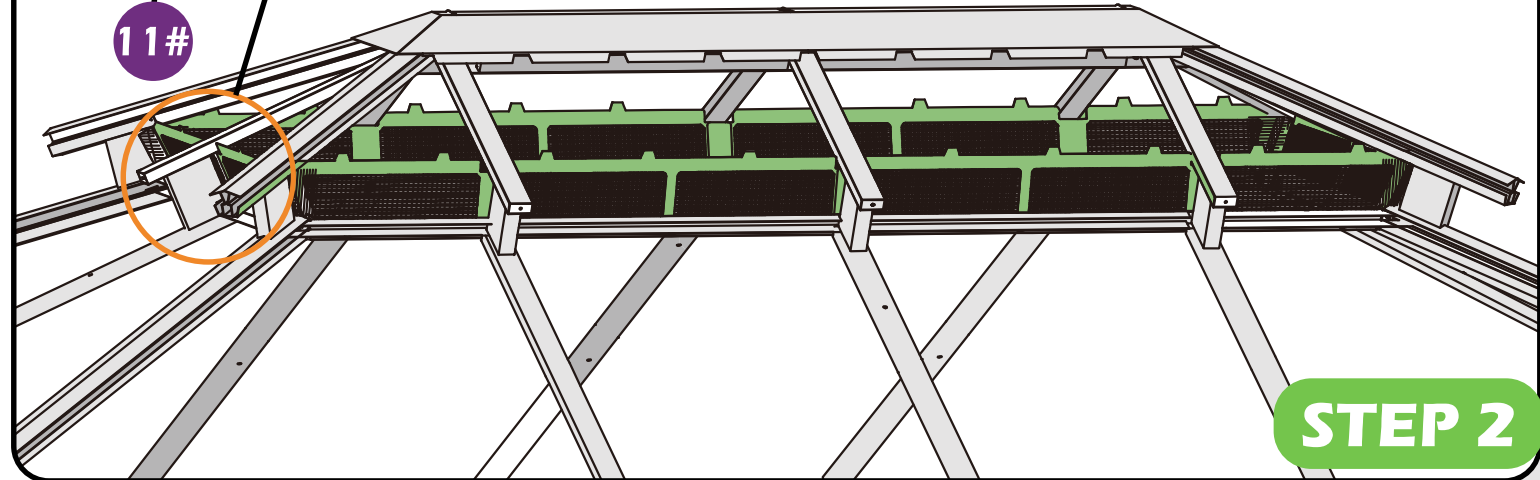

STEP 2

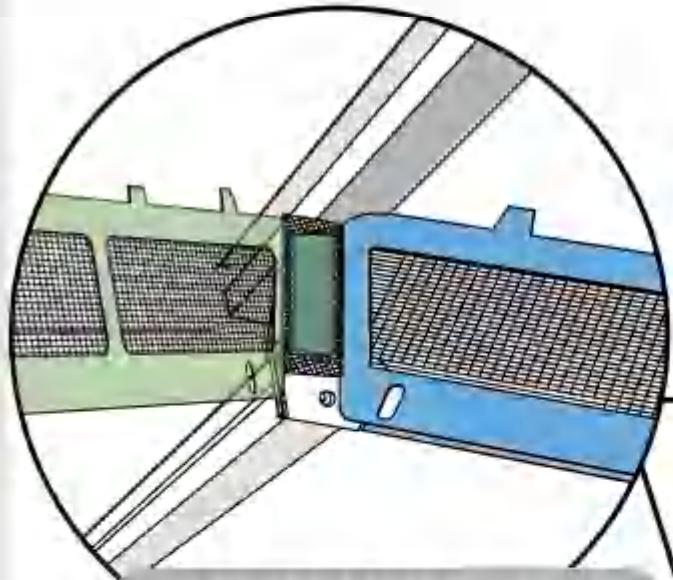
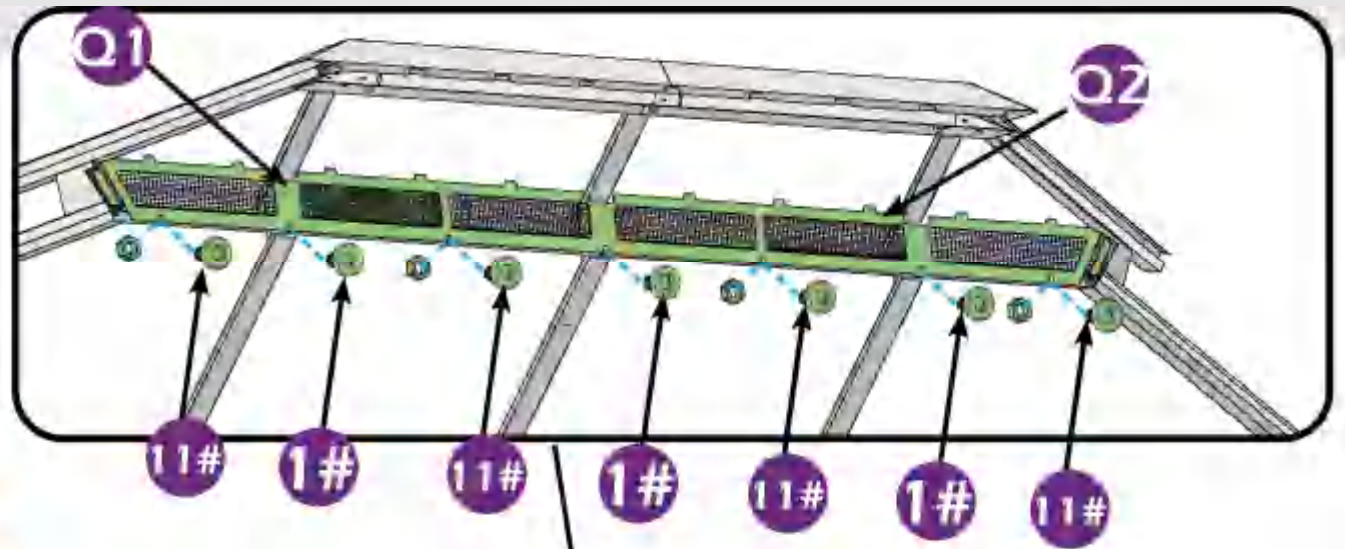

Don't forget to stick the velcro between the bug netting

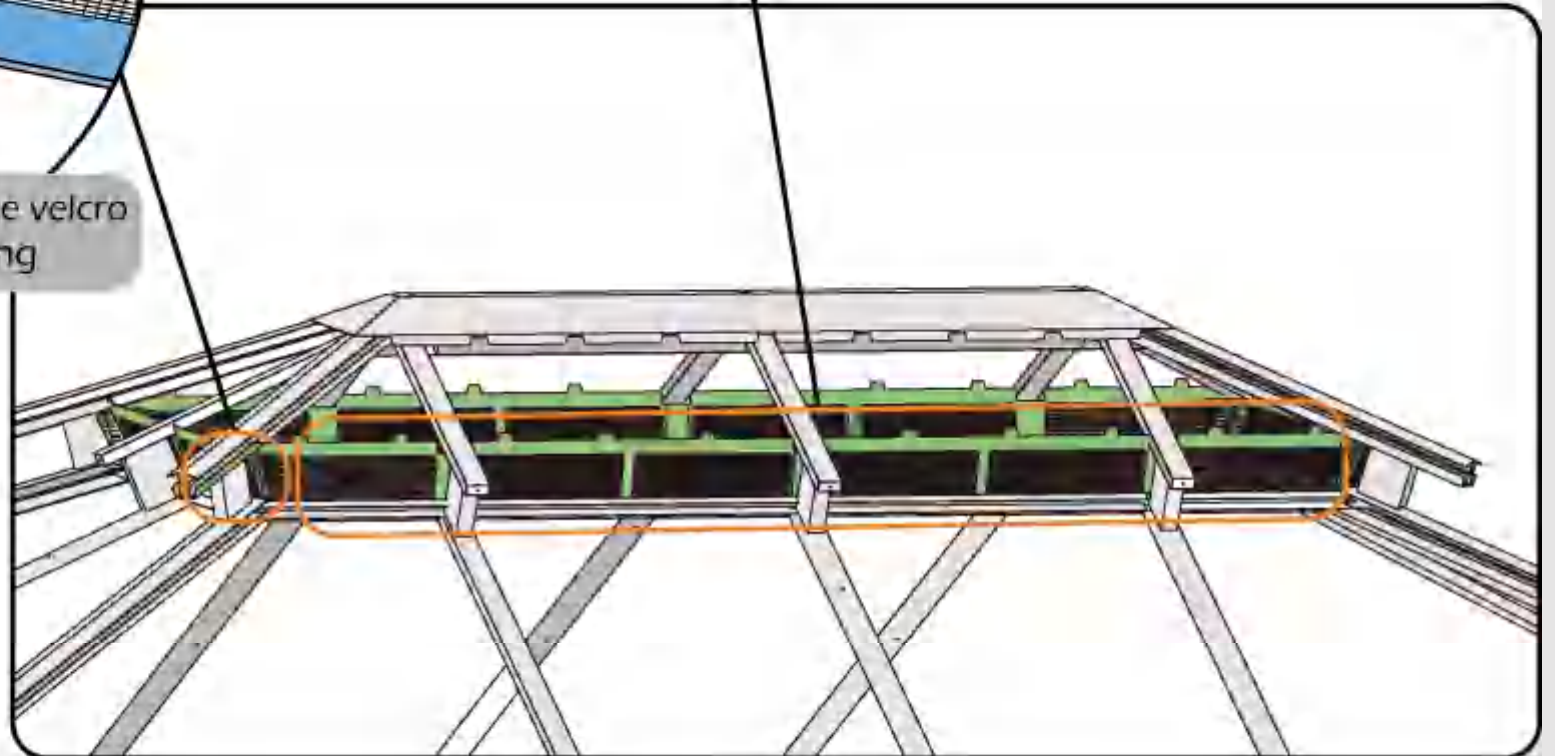

STEP 2

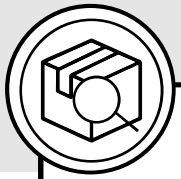

T1 × 2



R × 4

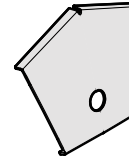

1# × 12

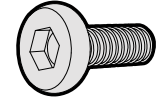

T2 × 2

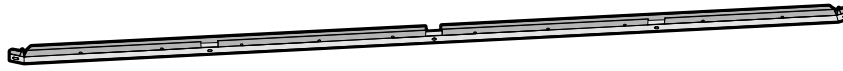

1#

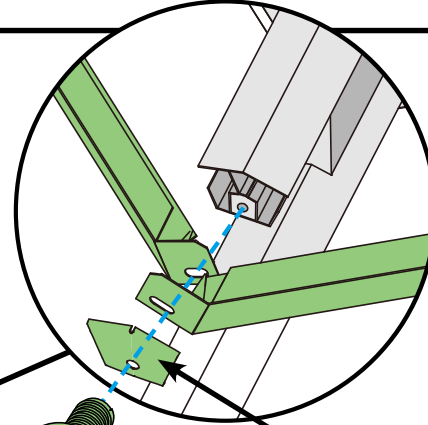
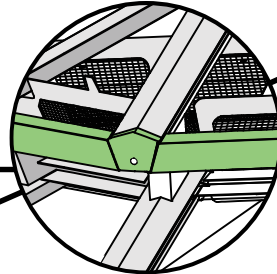
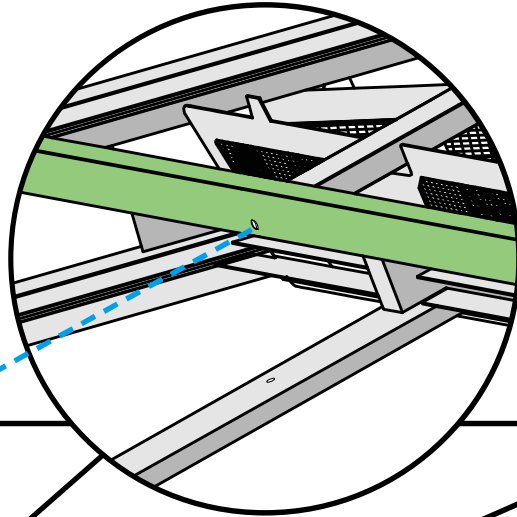
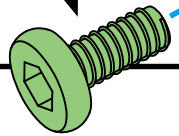

1#

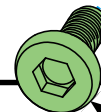

R

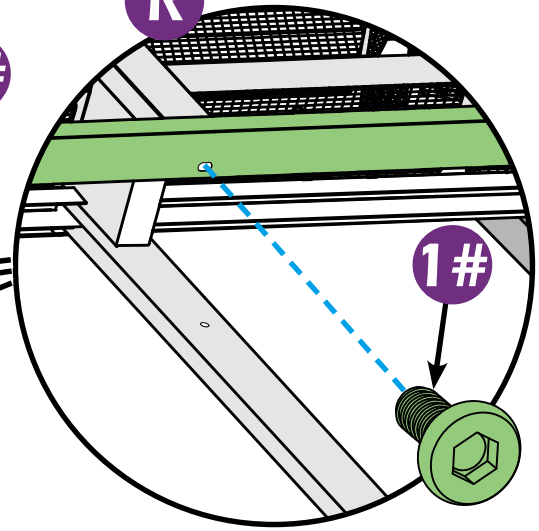

1#

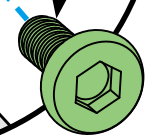

T1

T2

STEP 2

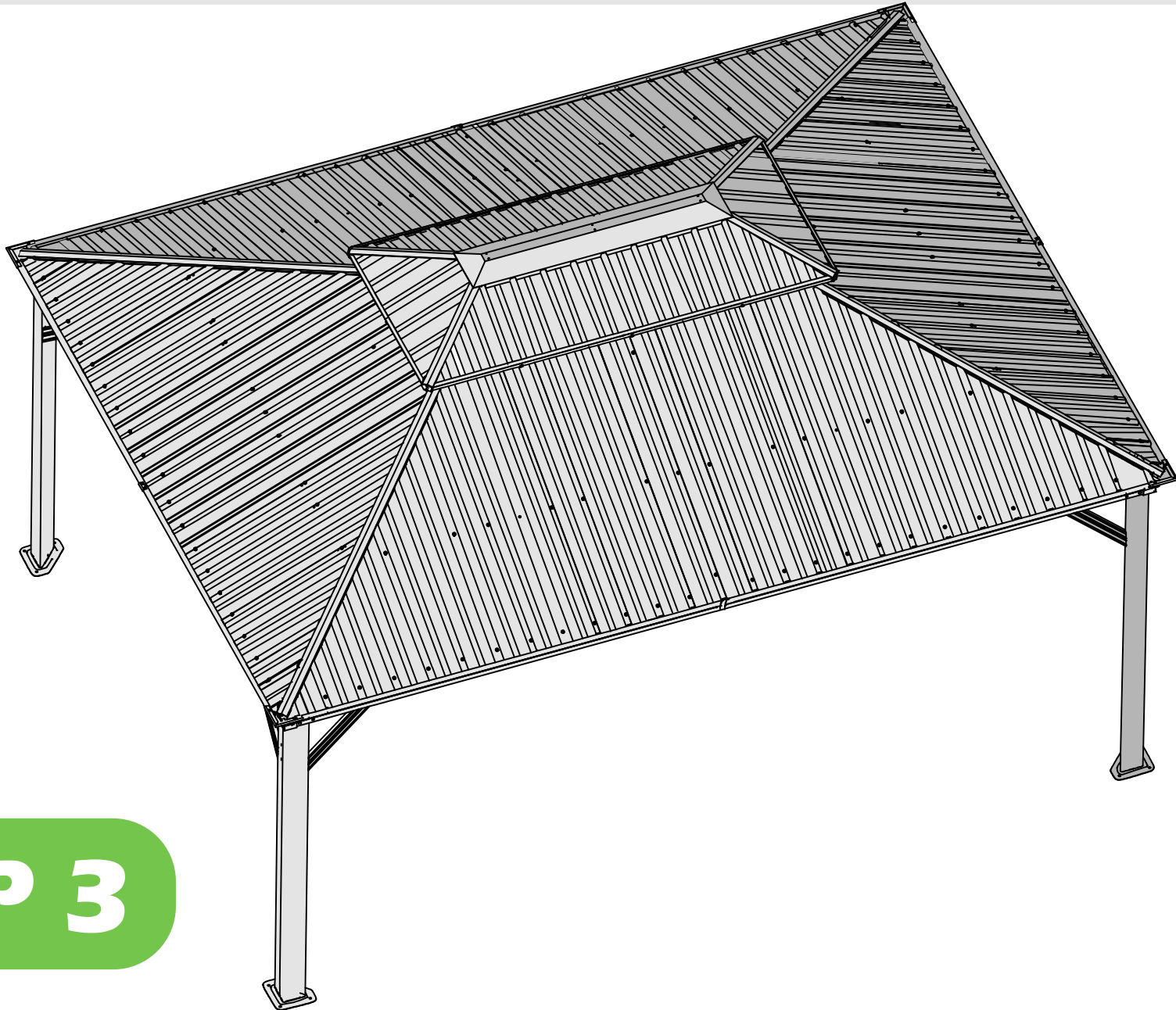

STEP 3

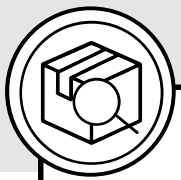

- V1** × 2
- V3** × 2
- V4** × 2
- V** × 4
- Z1** × 4
- V2** × 2
- V6** × 2
- V5** × 2
- Z** × 12
- Z2** × 4

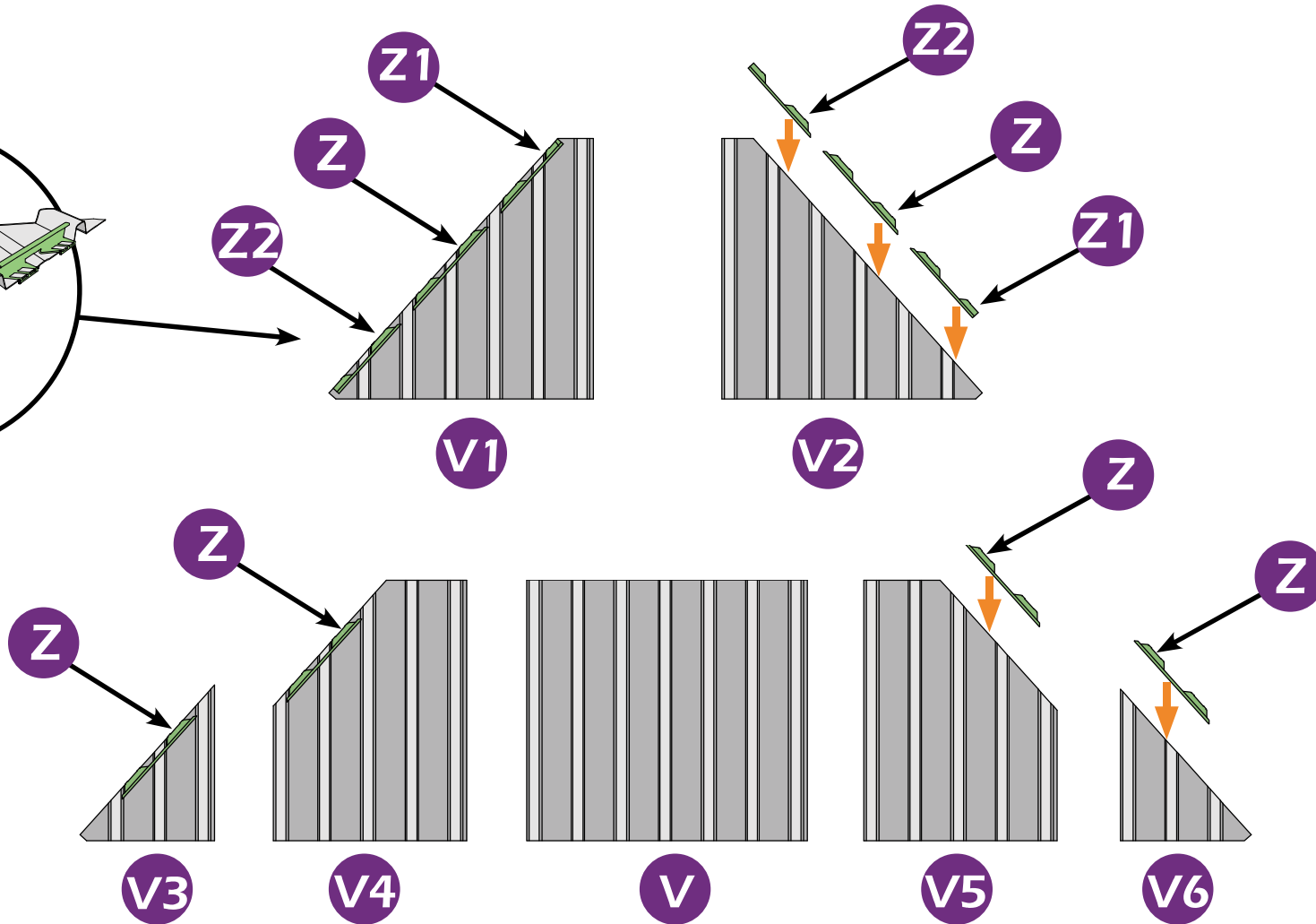
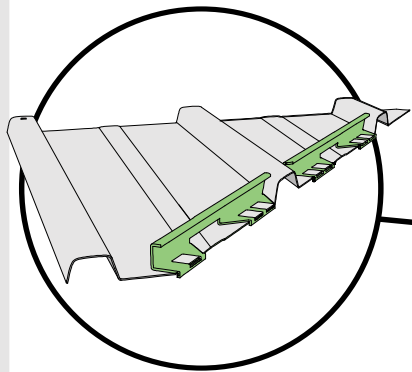

STEP 3

If you can't install **V4** or **V5**, push the part K up and try to insert them again.

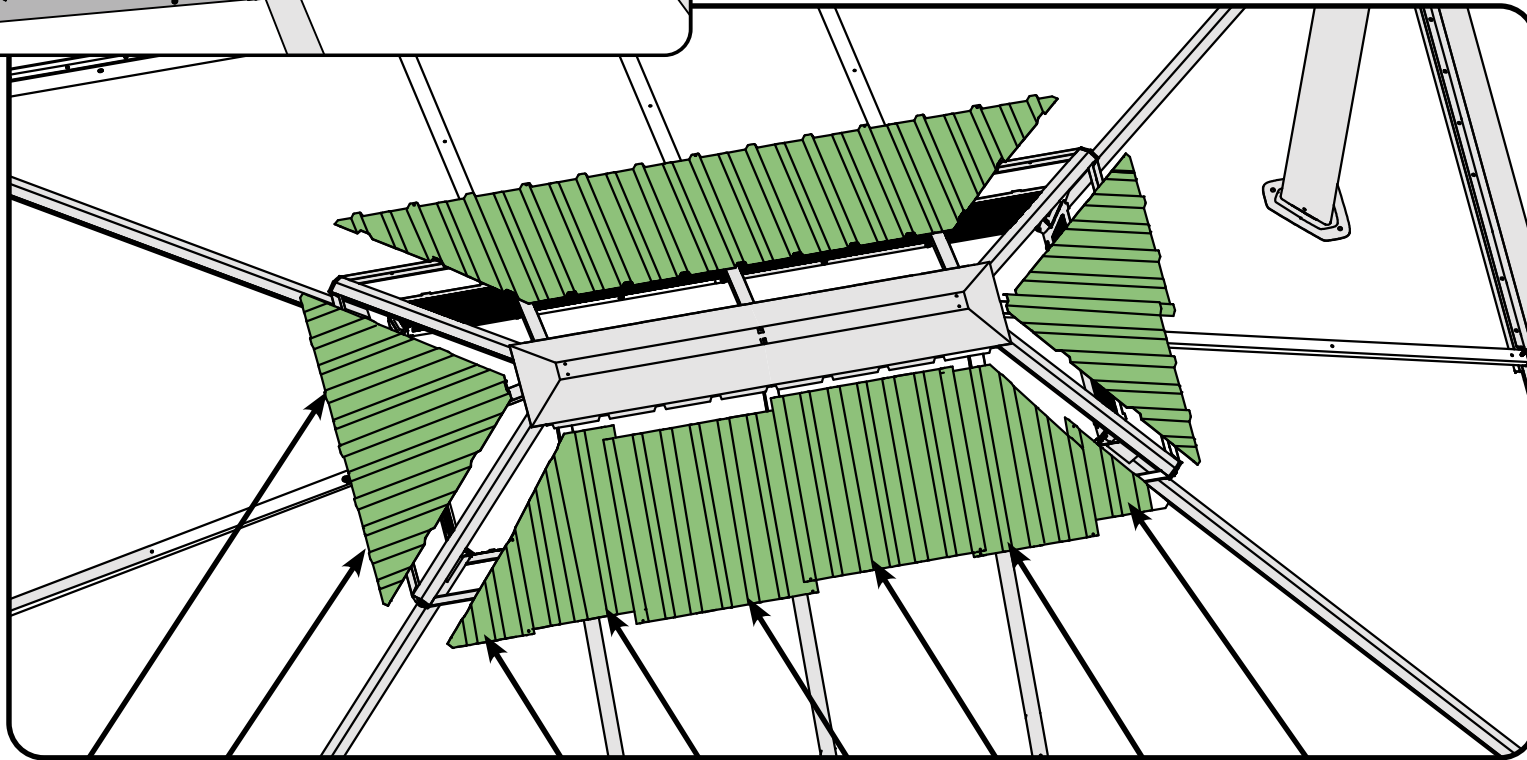
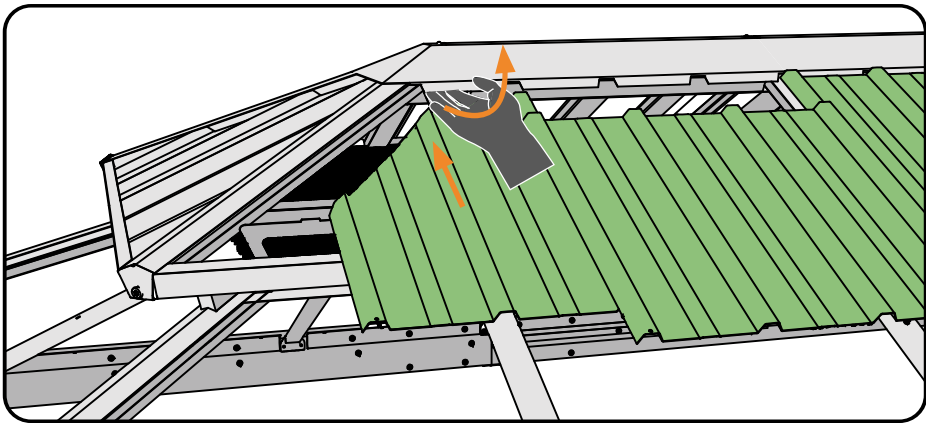

STEP 3

- V1
- V2
- ↓
- V3
- V4
- V
- V
- V5
- V6

1#

Fully fasten the 1# bolts in K & K1.

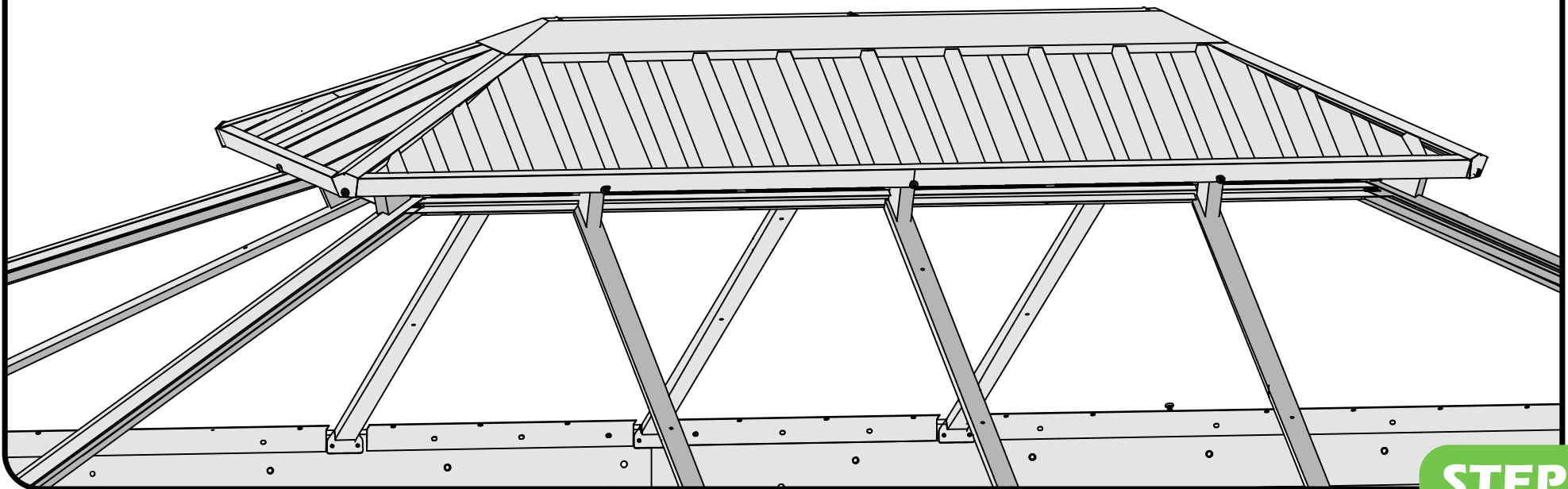
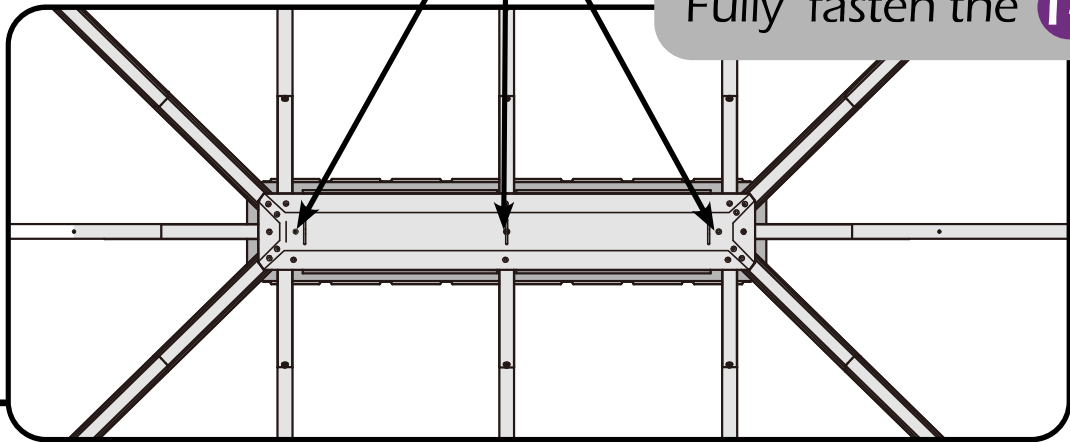

STEP 3

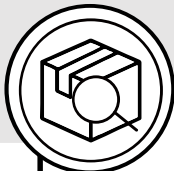

U1 × 4



U3 × 4

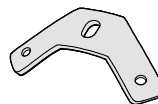

U4 × 6

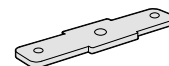

1# × 32

U2 × 4



U5 × 2

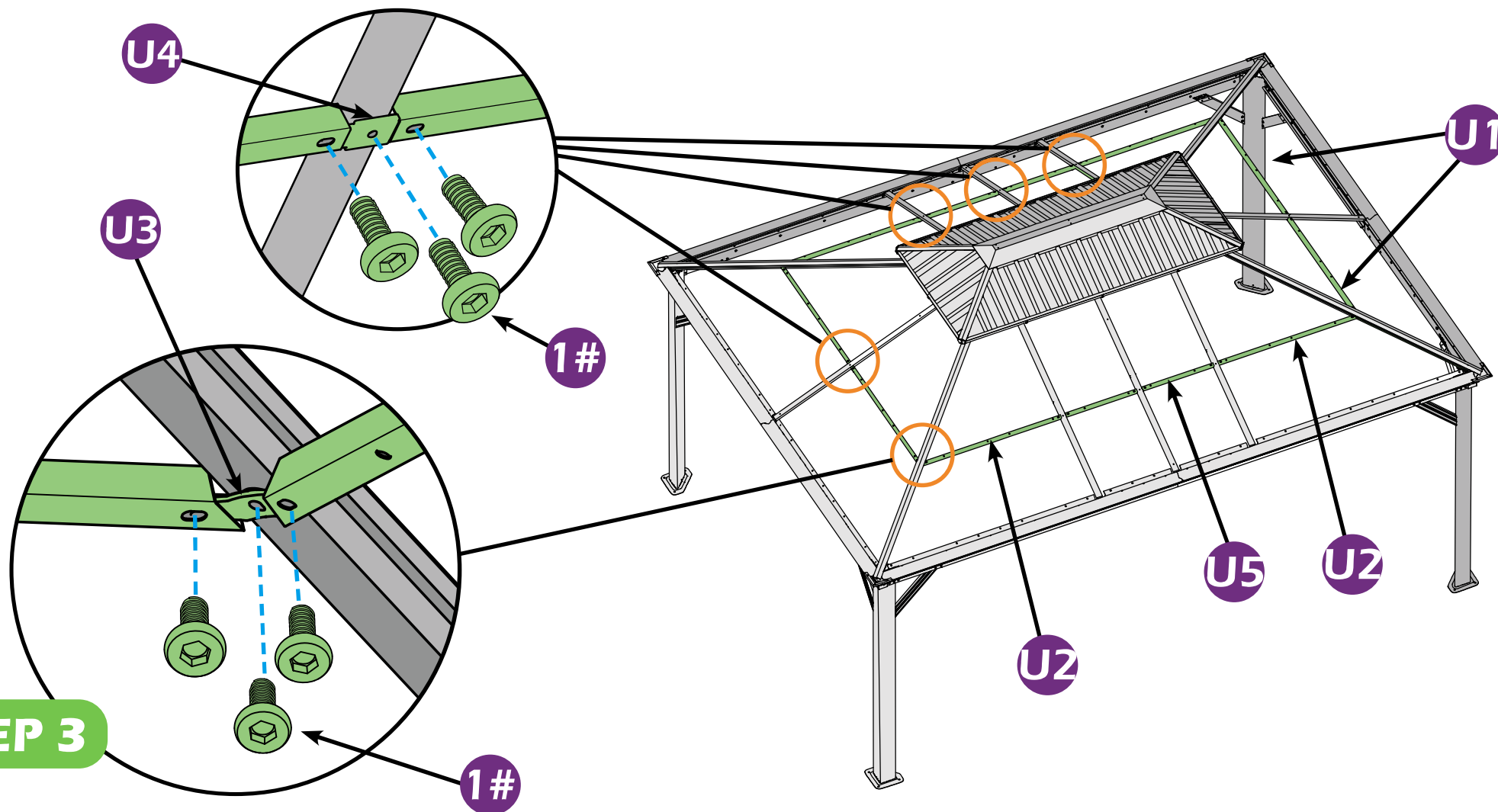
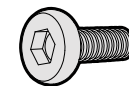

STEP 3

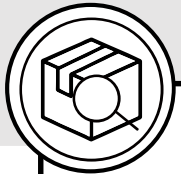

W1 x 2



W2 x 2

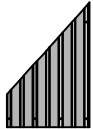

W3 x 2



W4 x 2



Z x 32



W8 x 2



W7 x 2

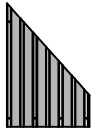

W6 x 2



W5 x 2

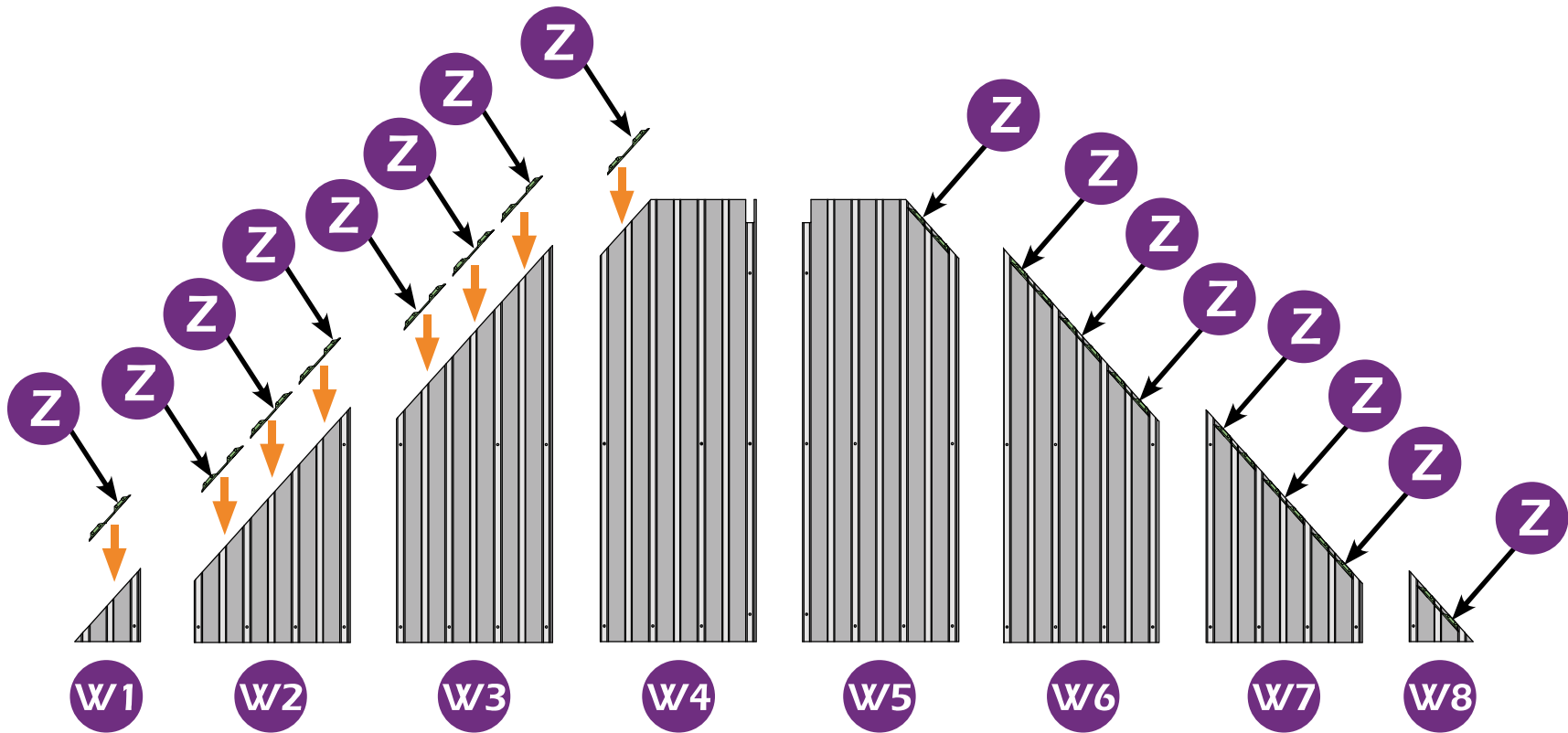

STEP 3

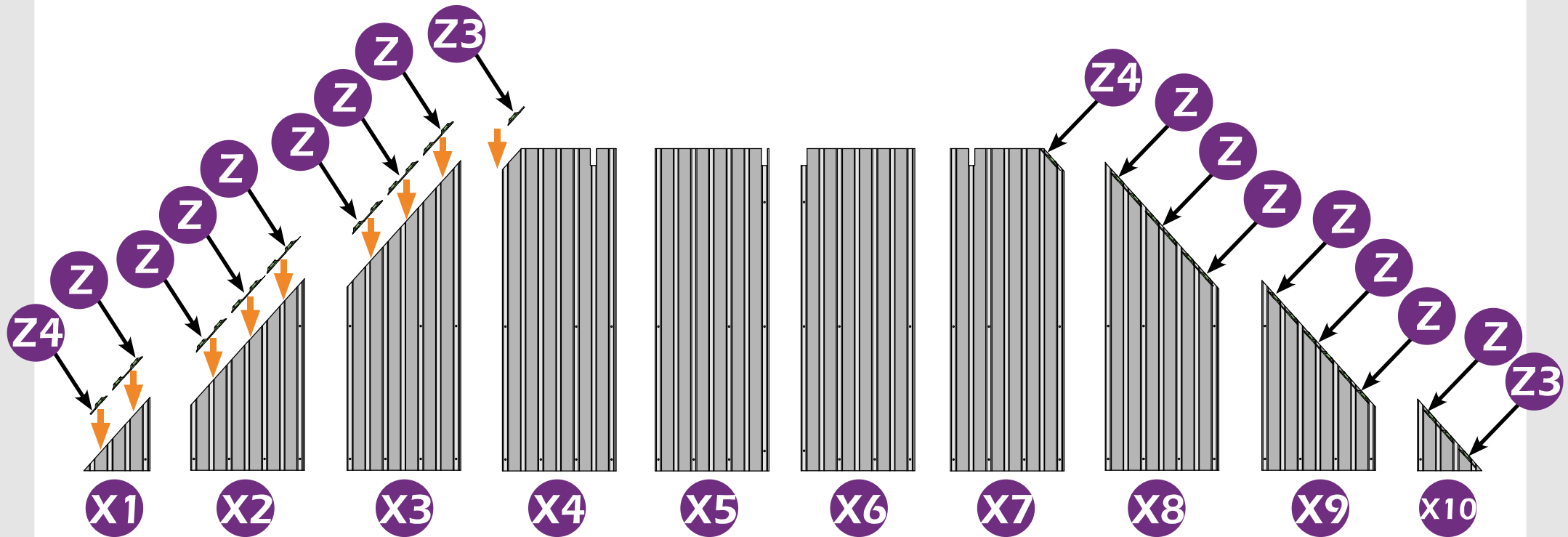
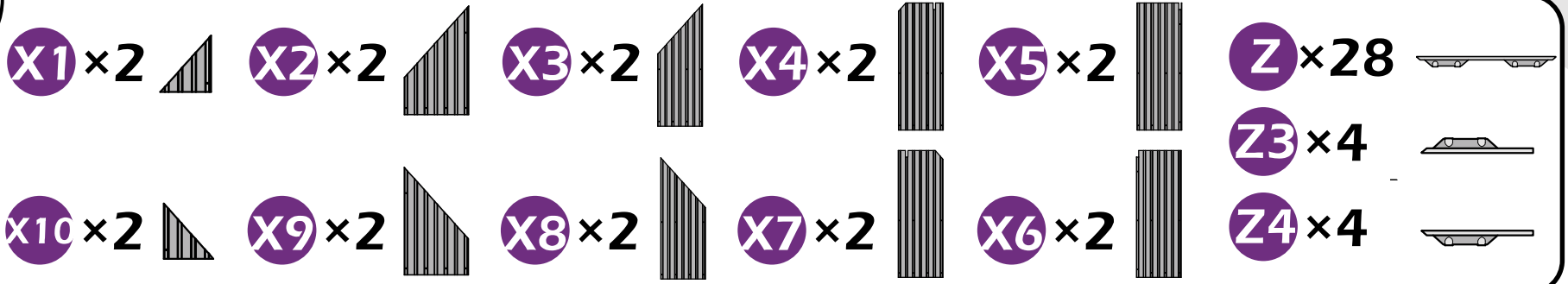
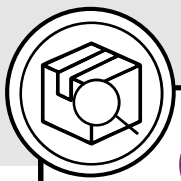

STEP 3

Install the middle panels (X5 , X6 or W4 , W5) then the small panels on the edge.

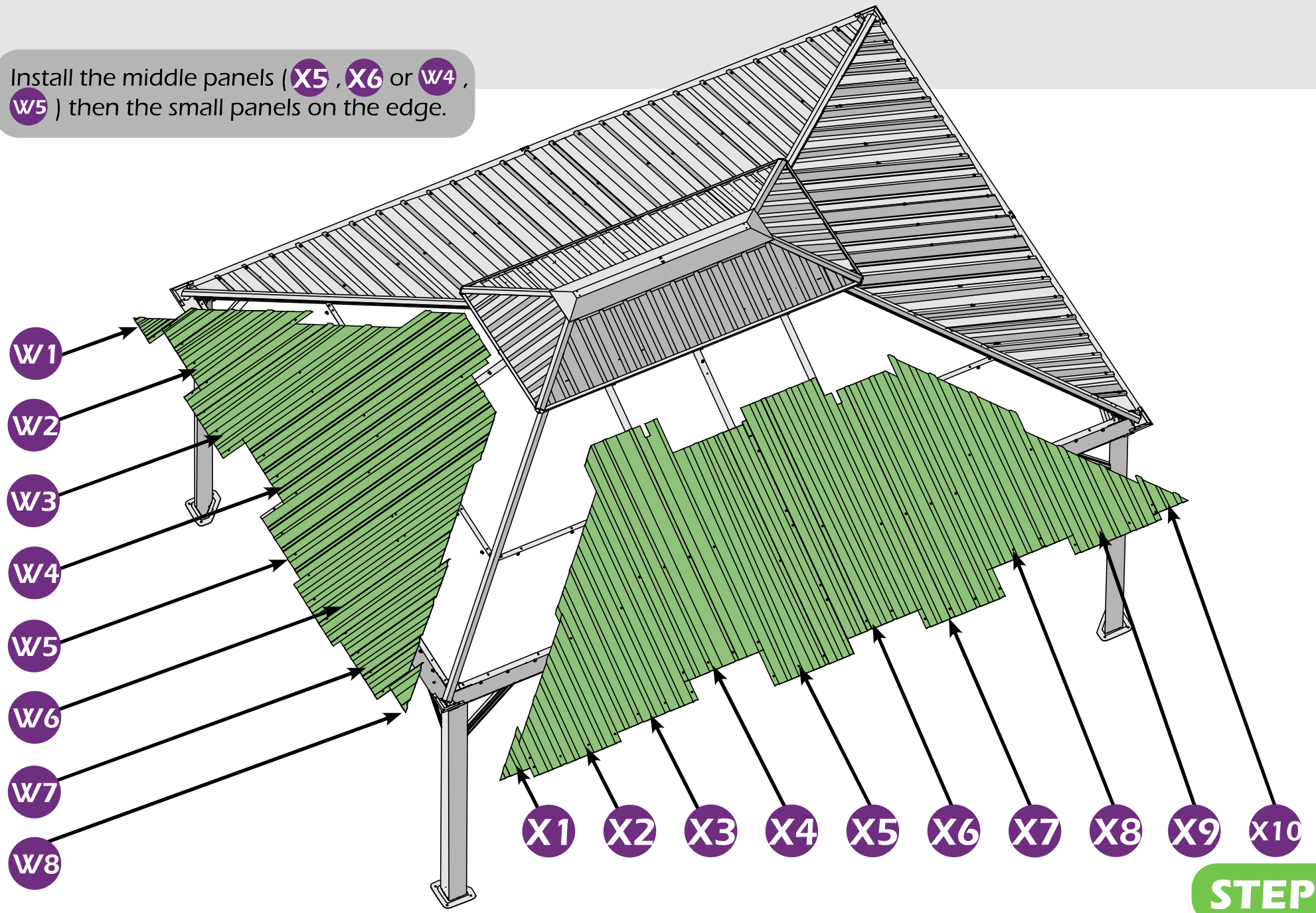

STEP 3

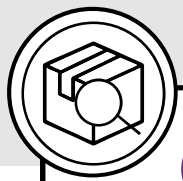

5#×84

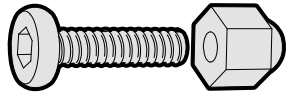

10#×4

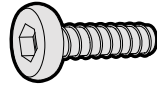

S×88

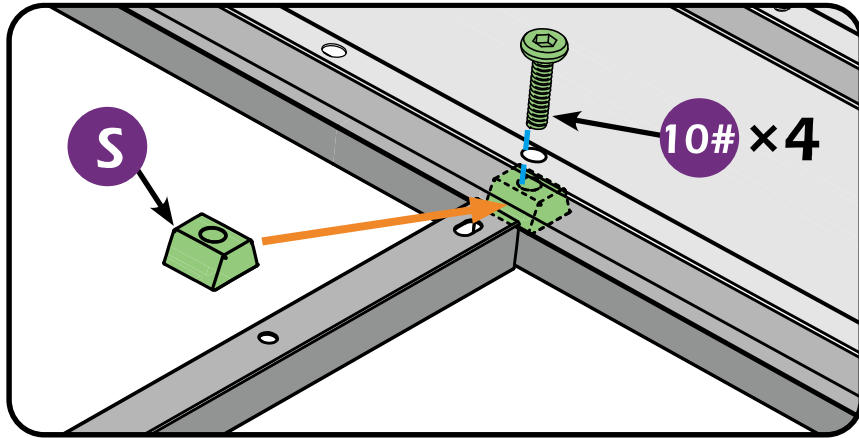
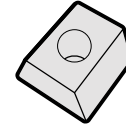

10#×4

S

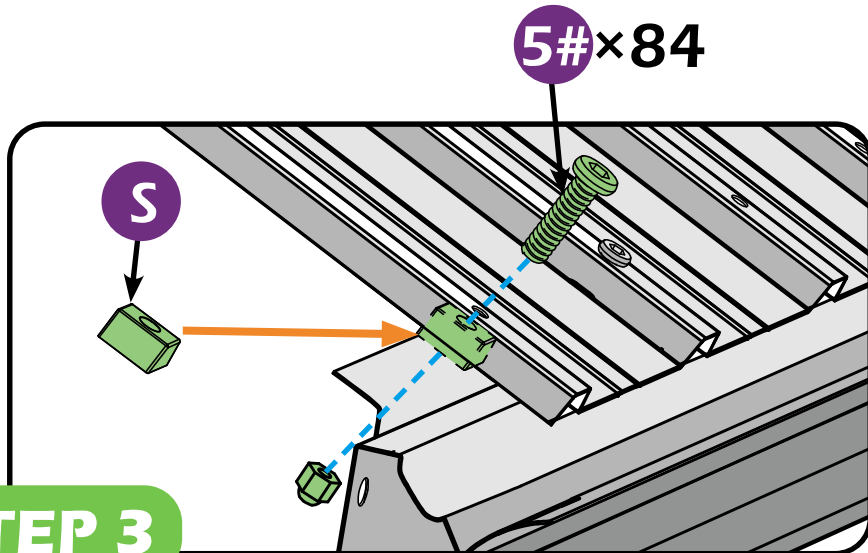

5#×84

S

STEP 3

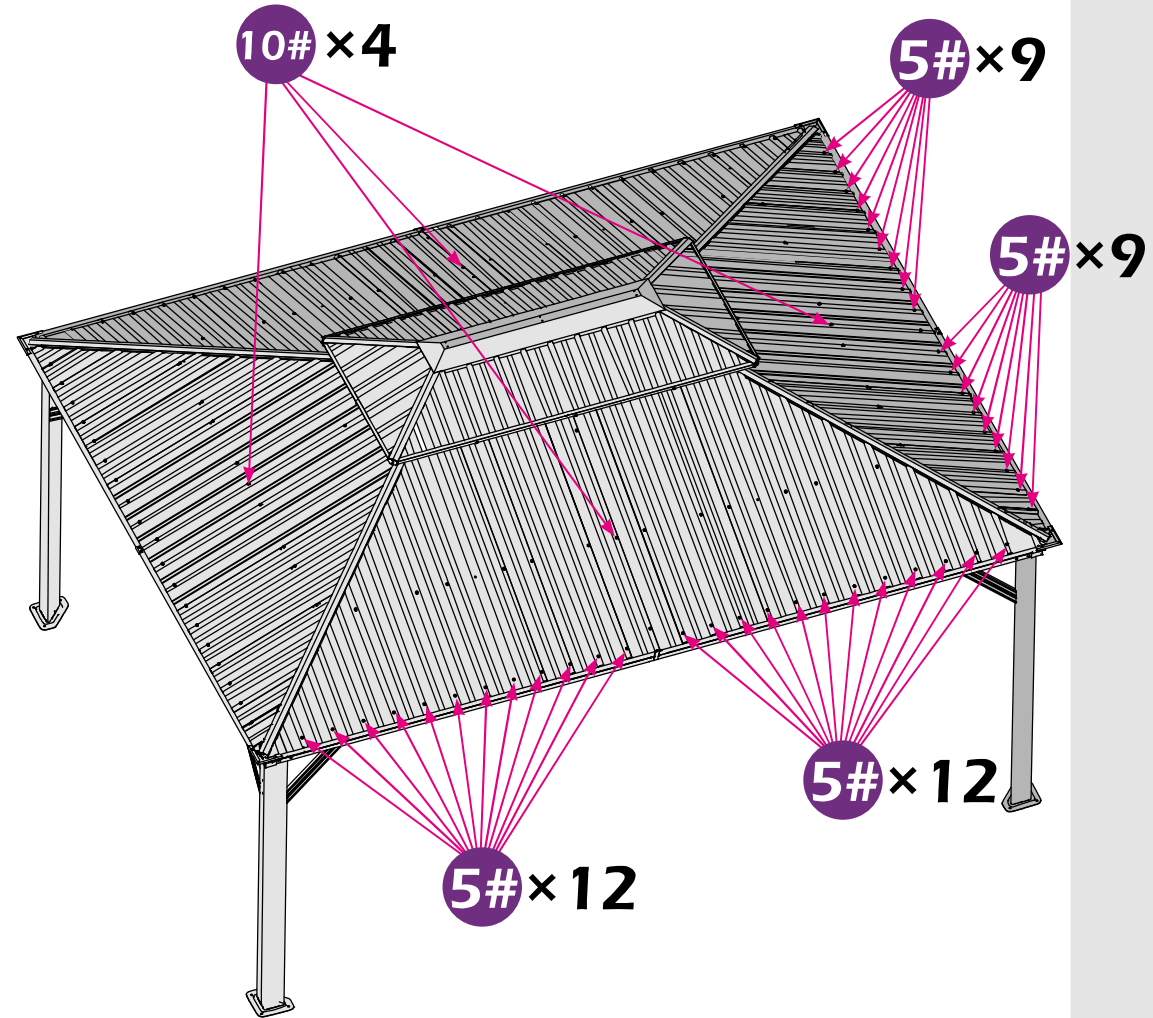

10#×4

5#×9

5#×9

5#×12

5#×12

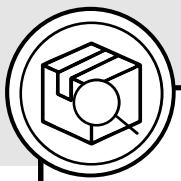

6#×8

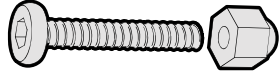

7#×40

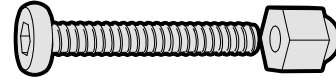

S×48

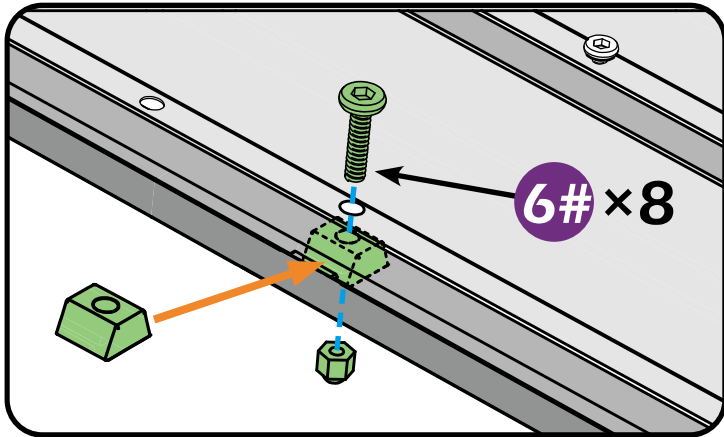
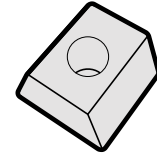

6#×8

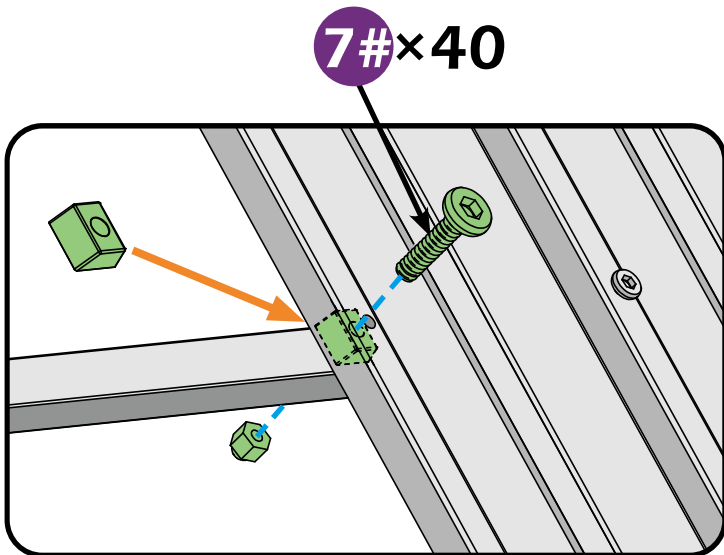

7#×40

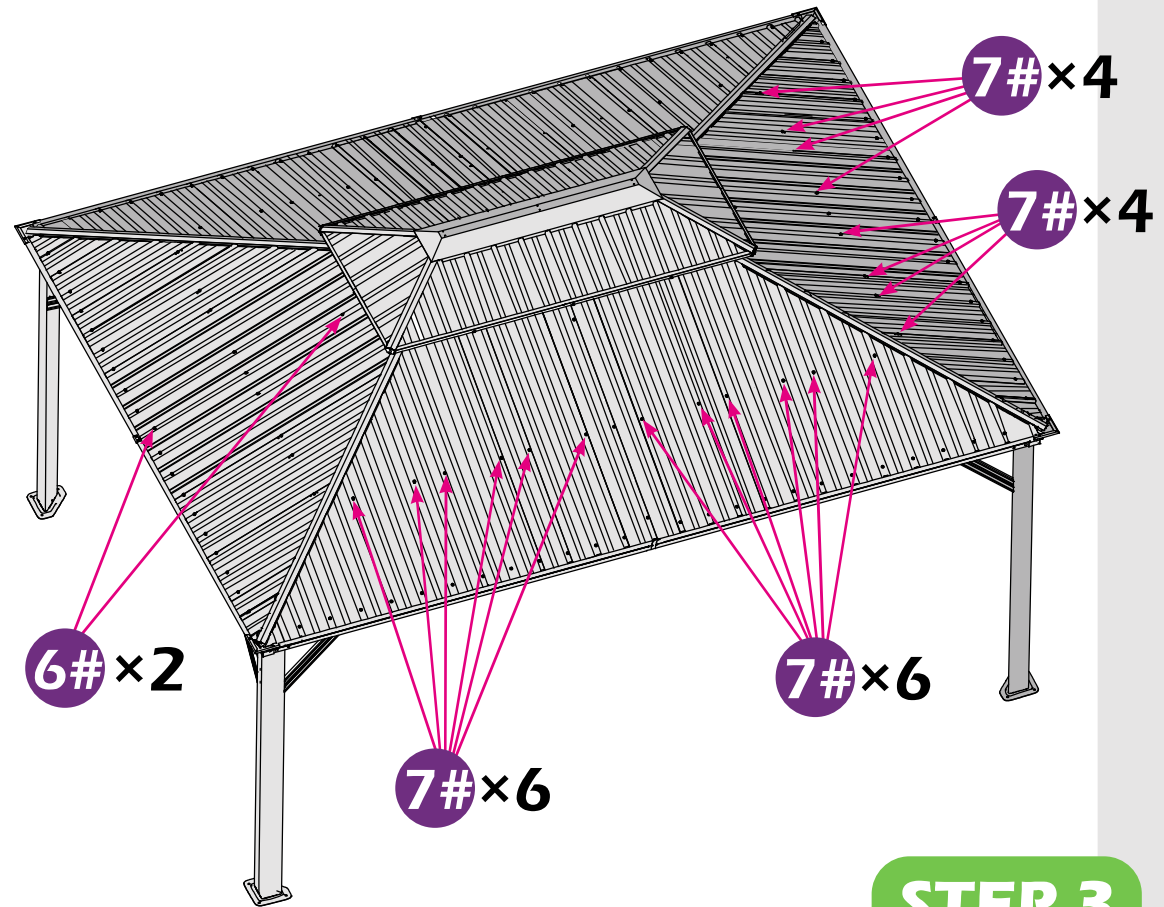

STEP 3

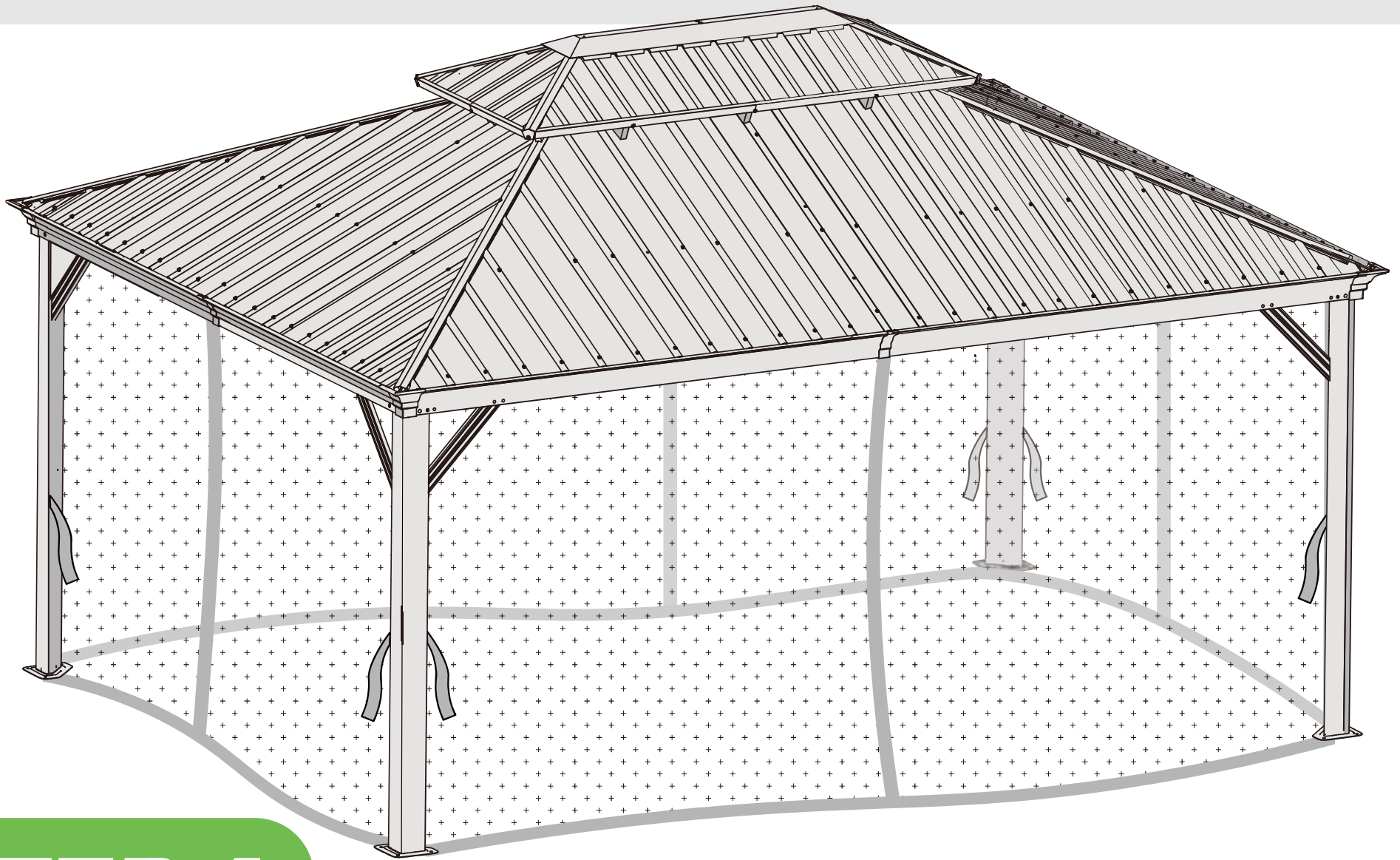

STEP 4



B2 × 2



1# × 20



C2 × 2

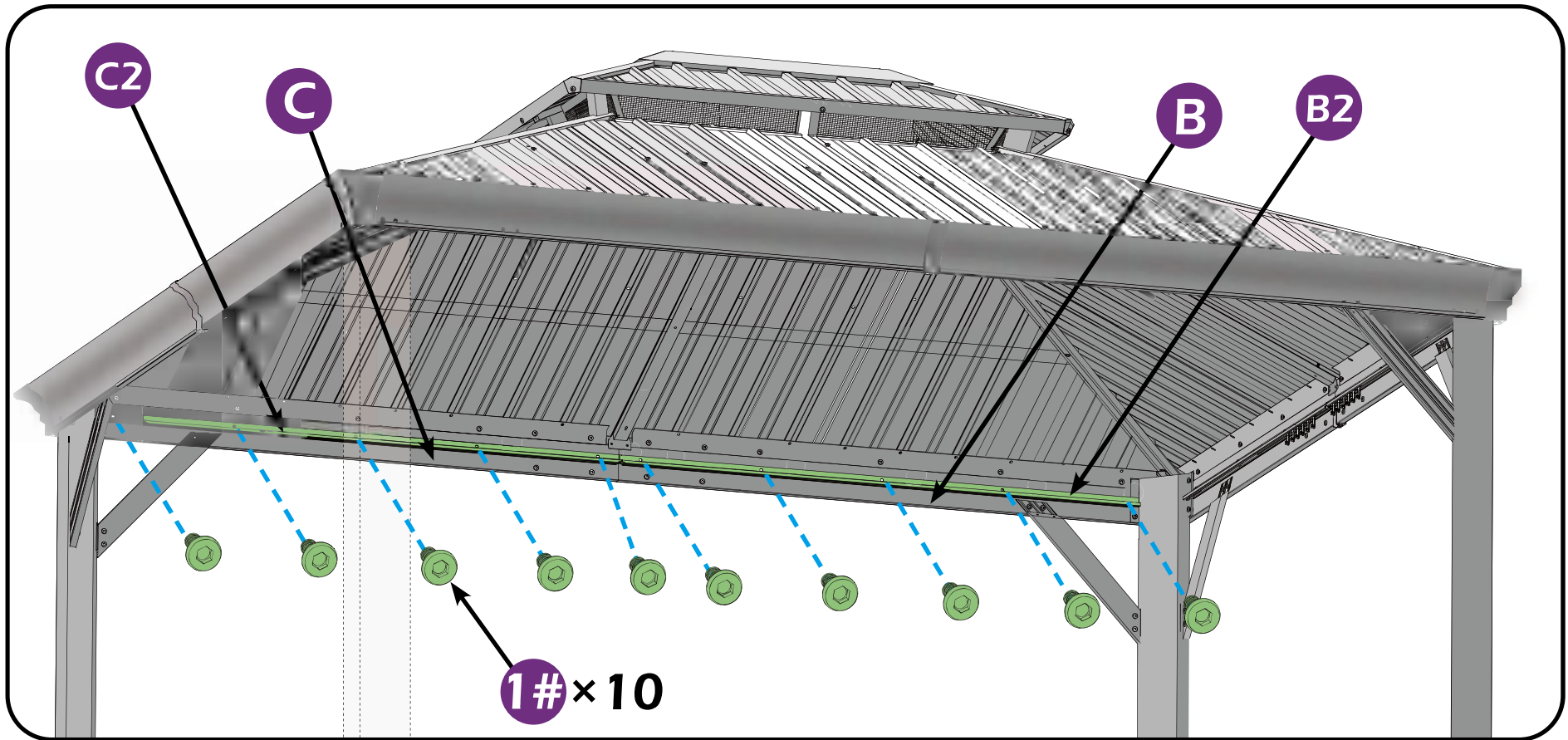

1# × 10

STEP 4



D2 × 2



1# × 28

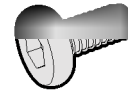

E2 × 2

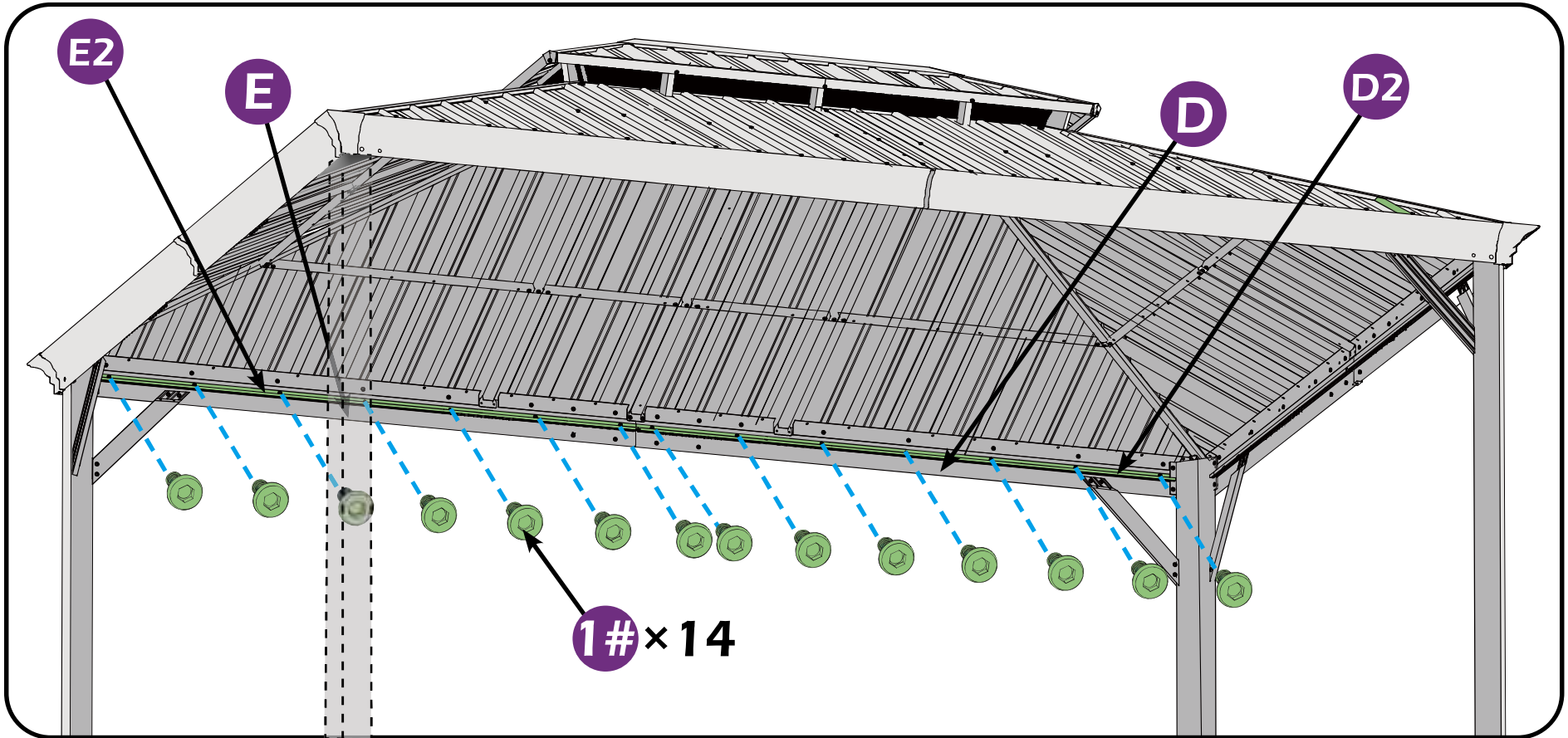

STEP 4



4#×28

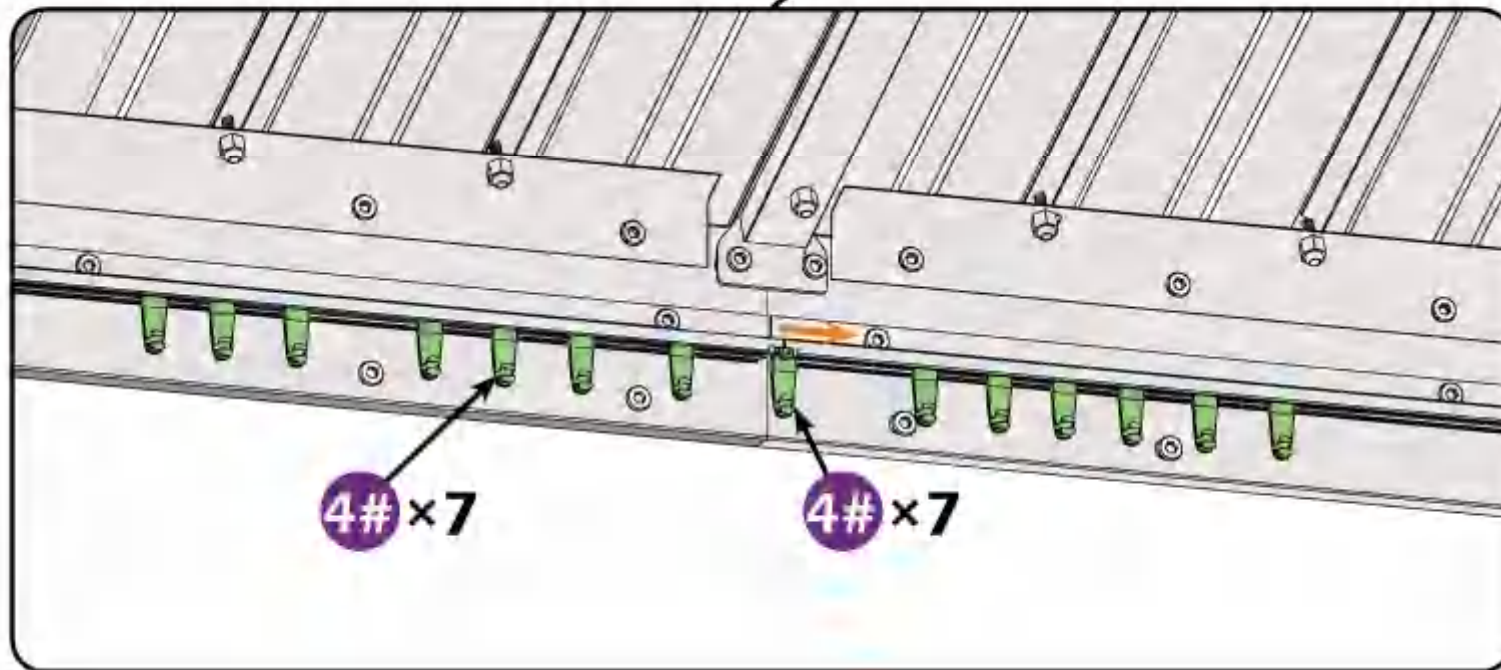
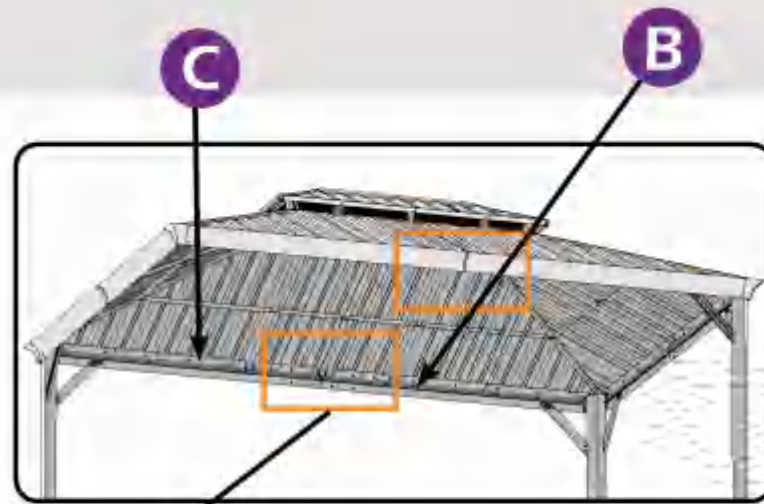

STEP 4

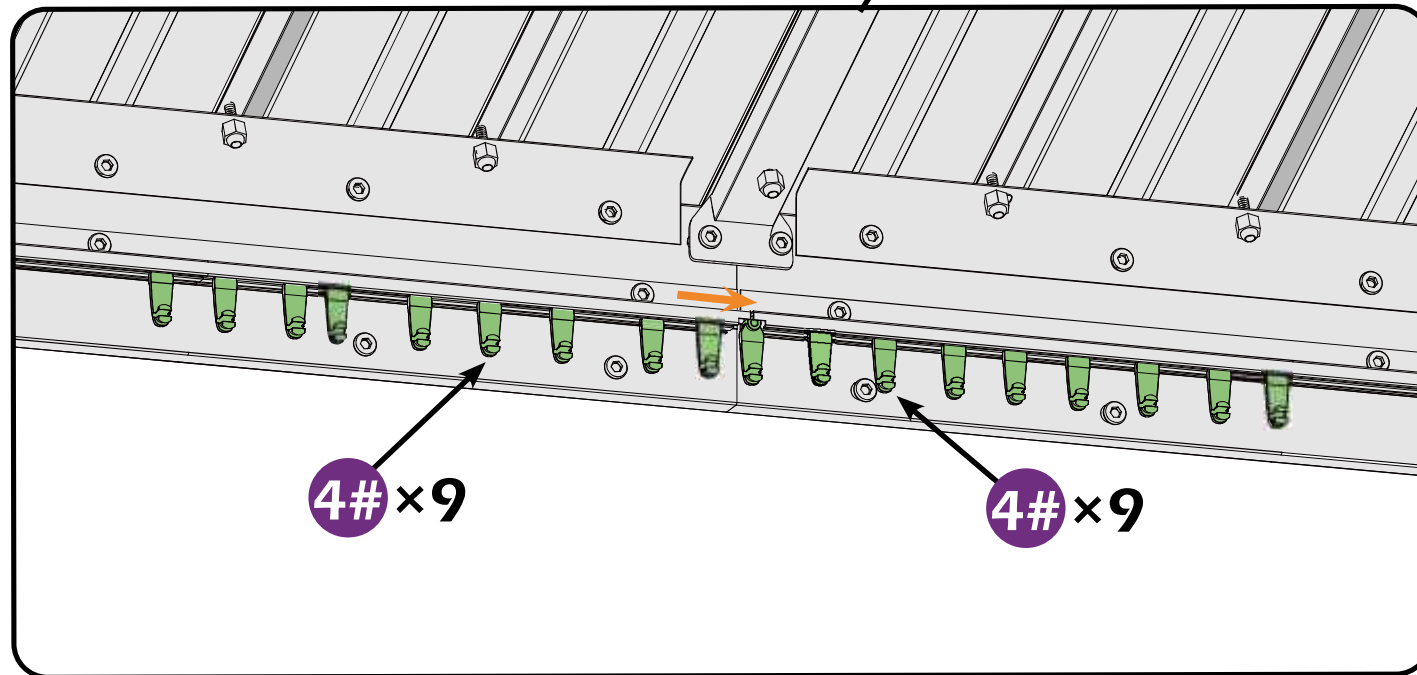
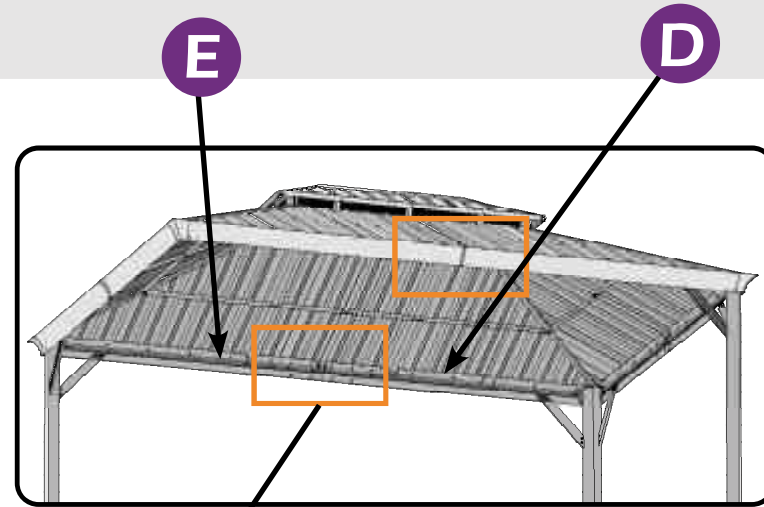
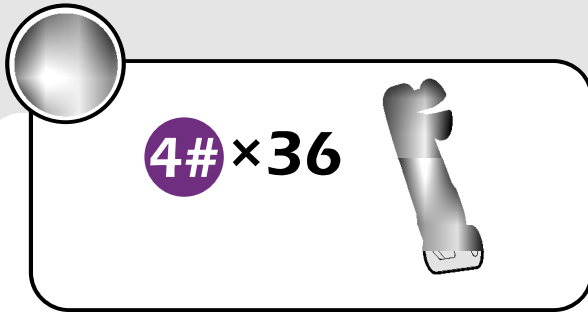

STEP 4



H×4

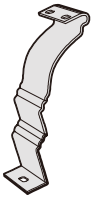

H1×4

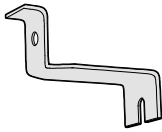

8#×4

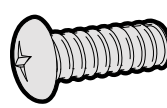

9#×8

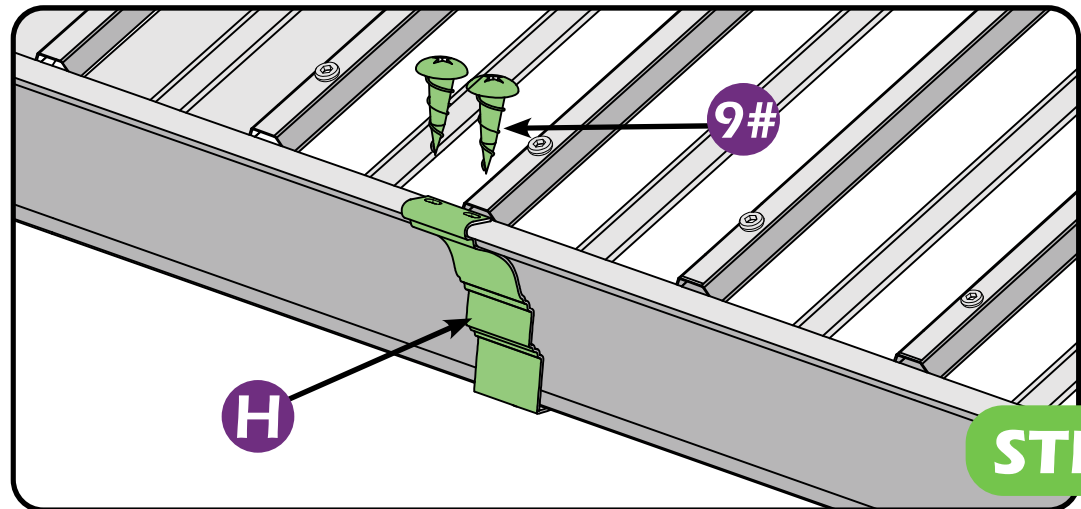
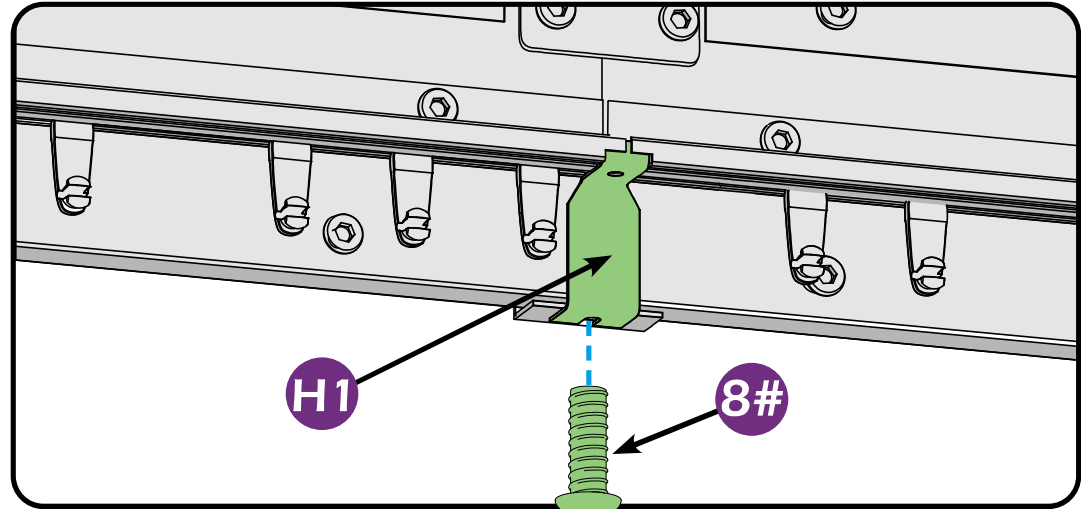
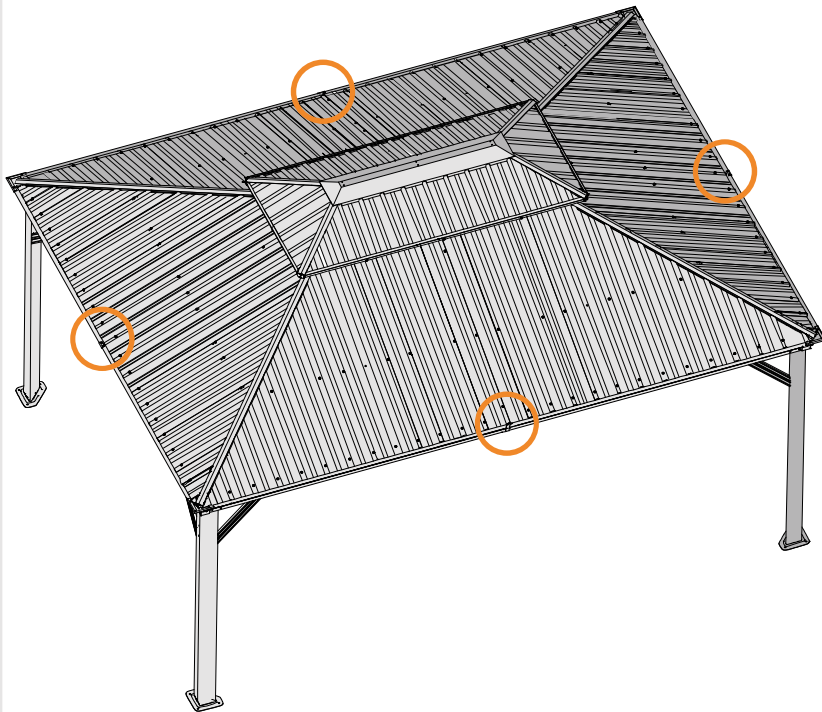
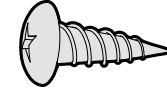

STEP 4



H2 × 1

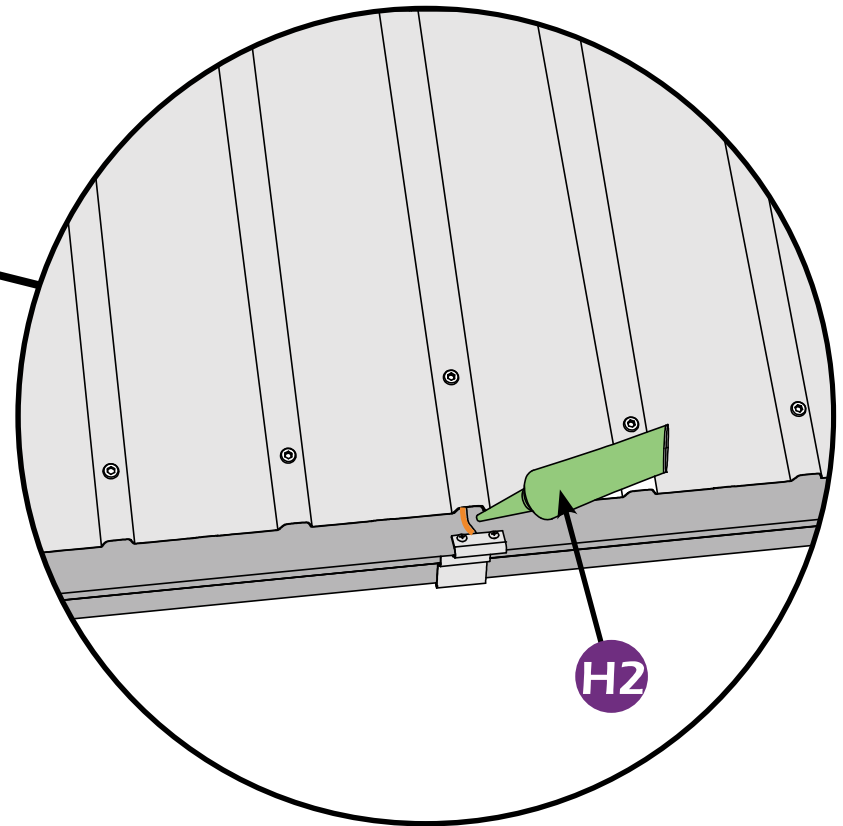
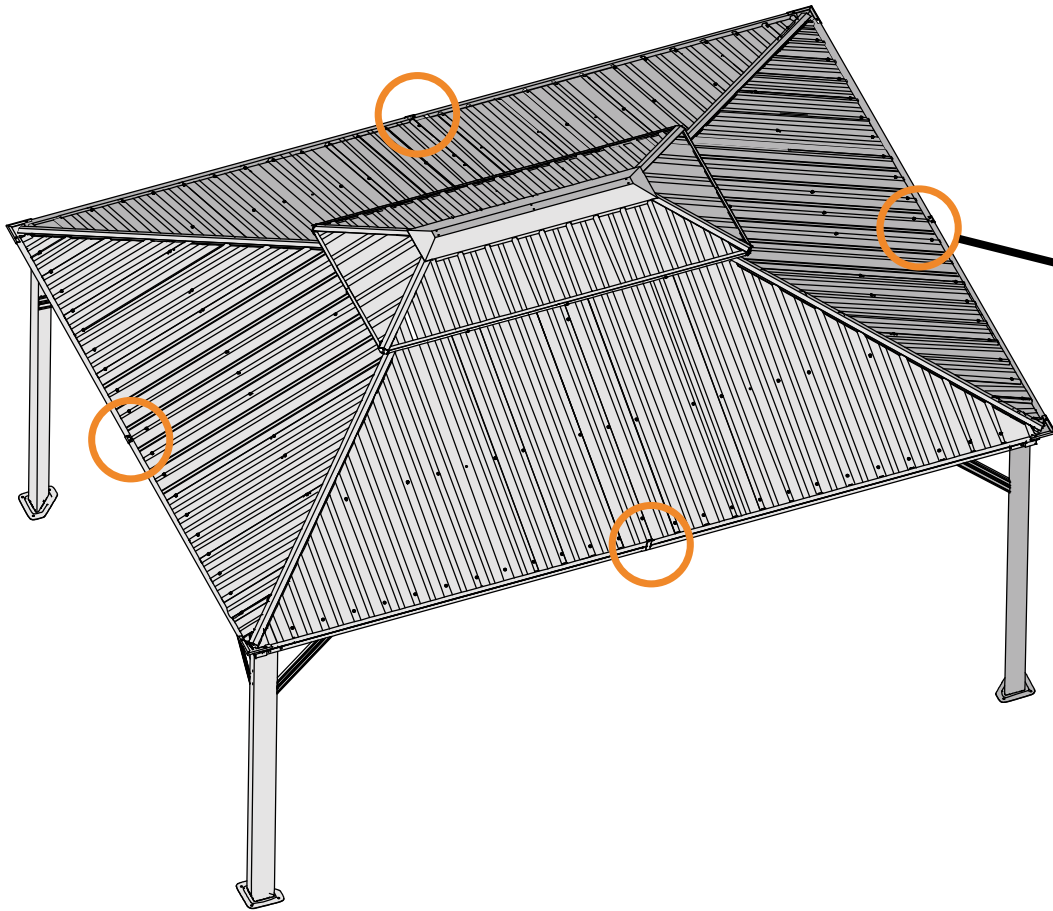
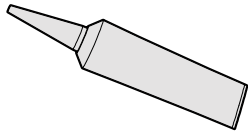

STEP 4



Y × 4

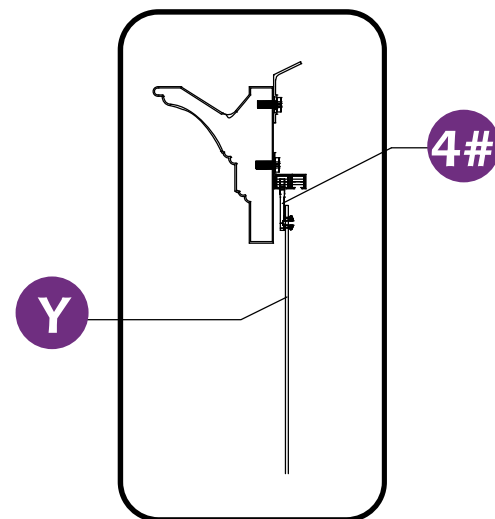
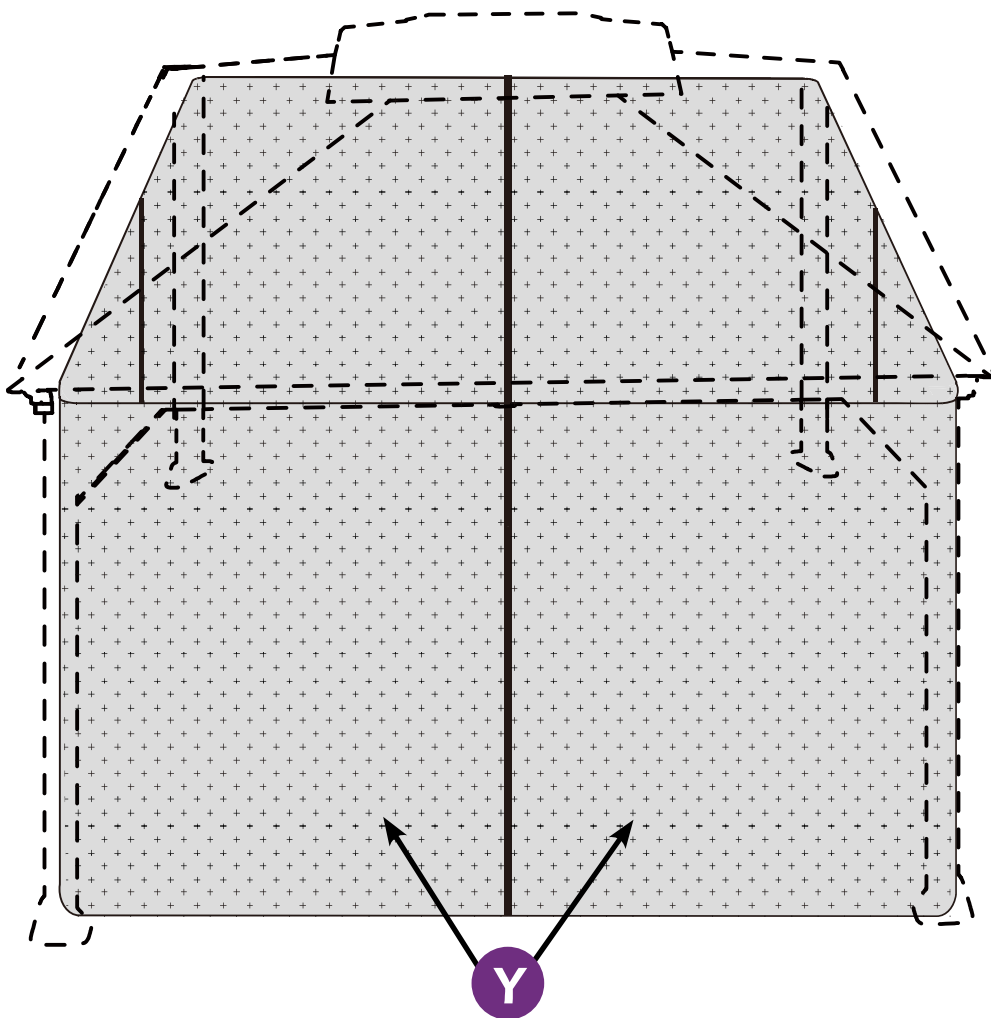
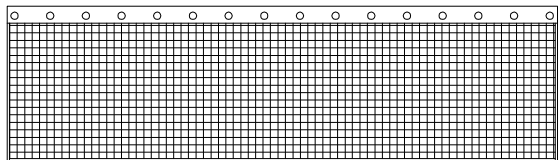

STEP 4

There are 14 hooks in width(7 in each side).

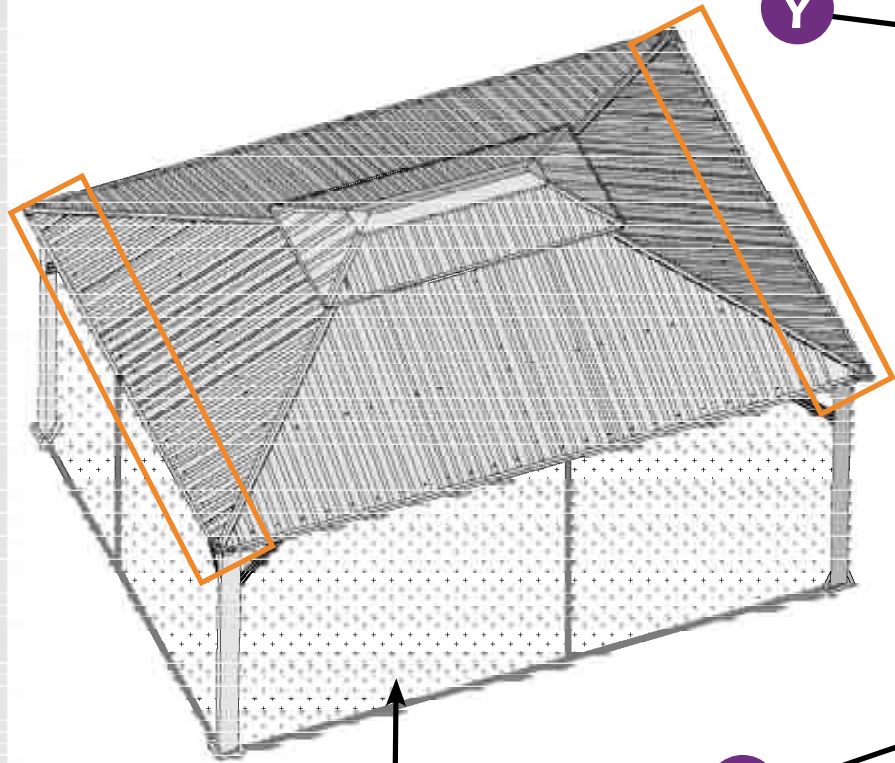

Y

Y

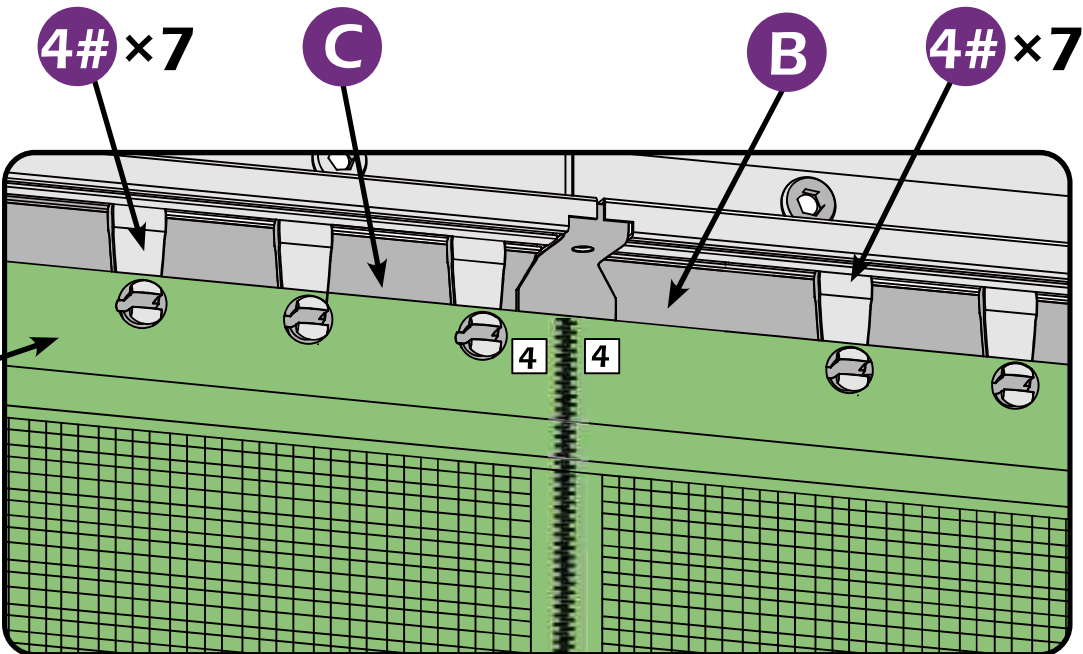
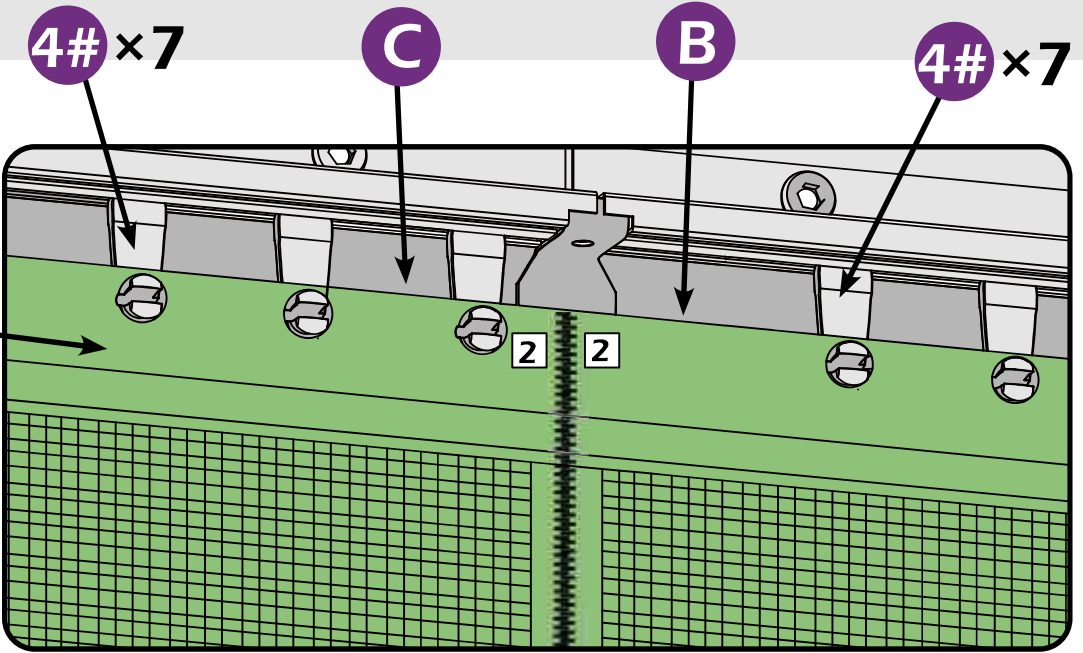

STEP 4

There are 18 hooks in length(9 in each side).

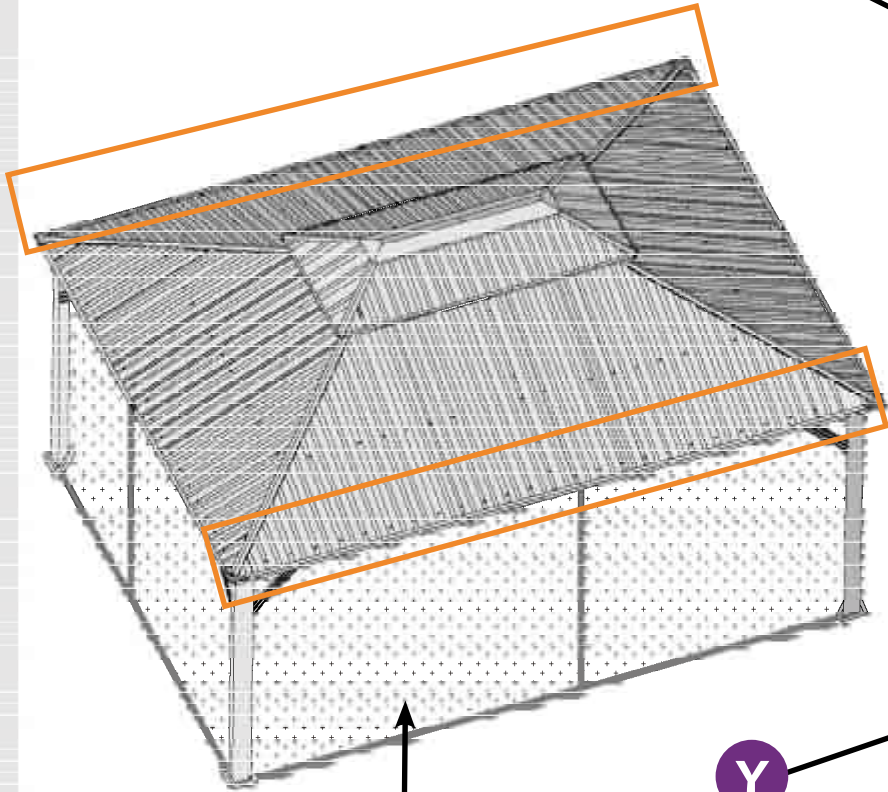

Y

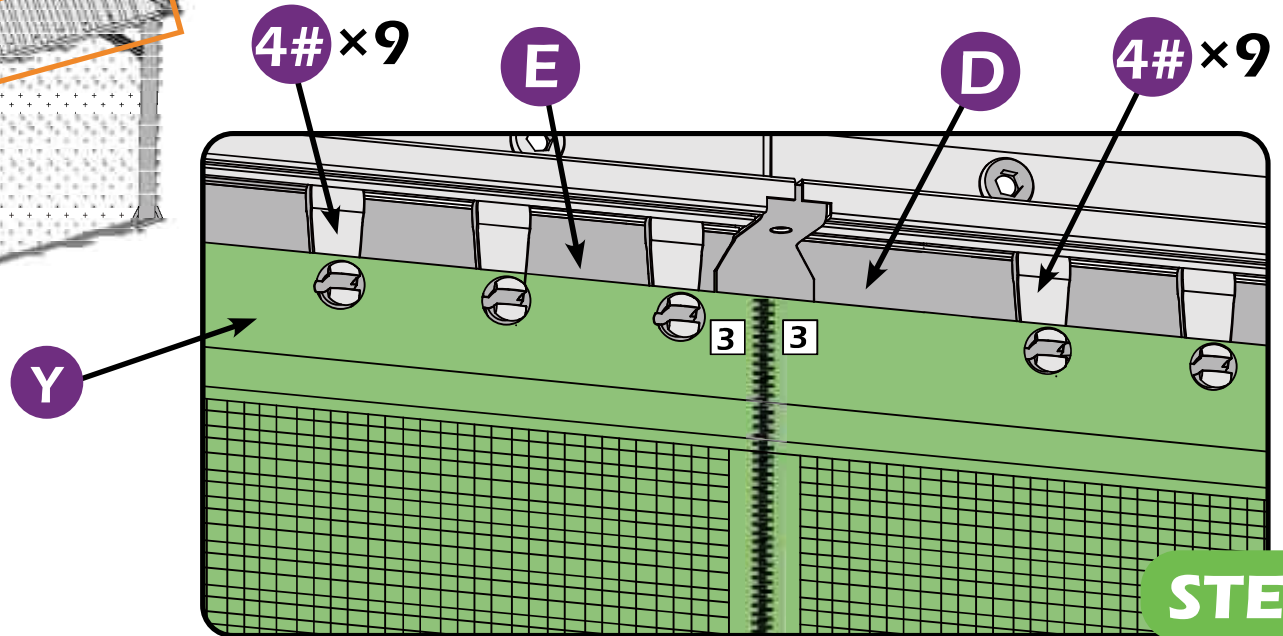
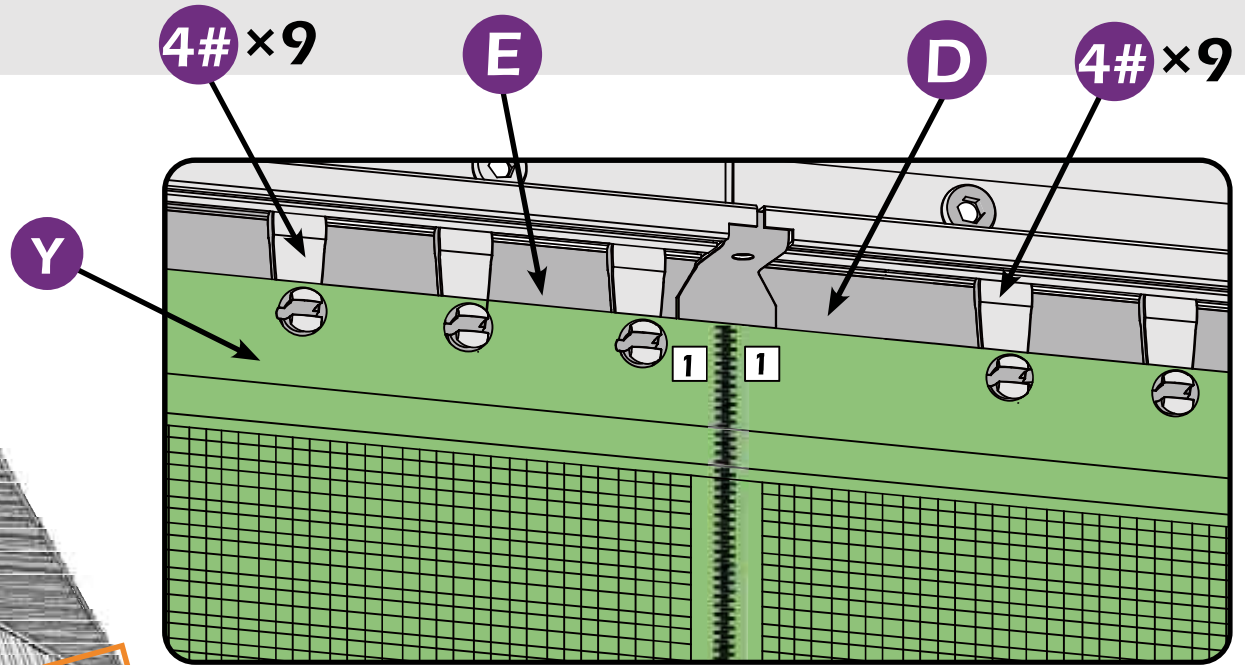

STEP 4

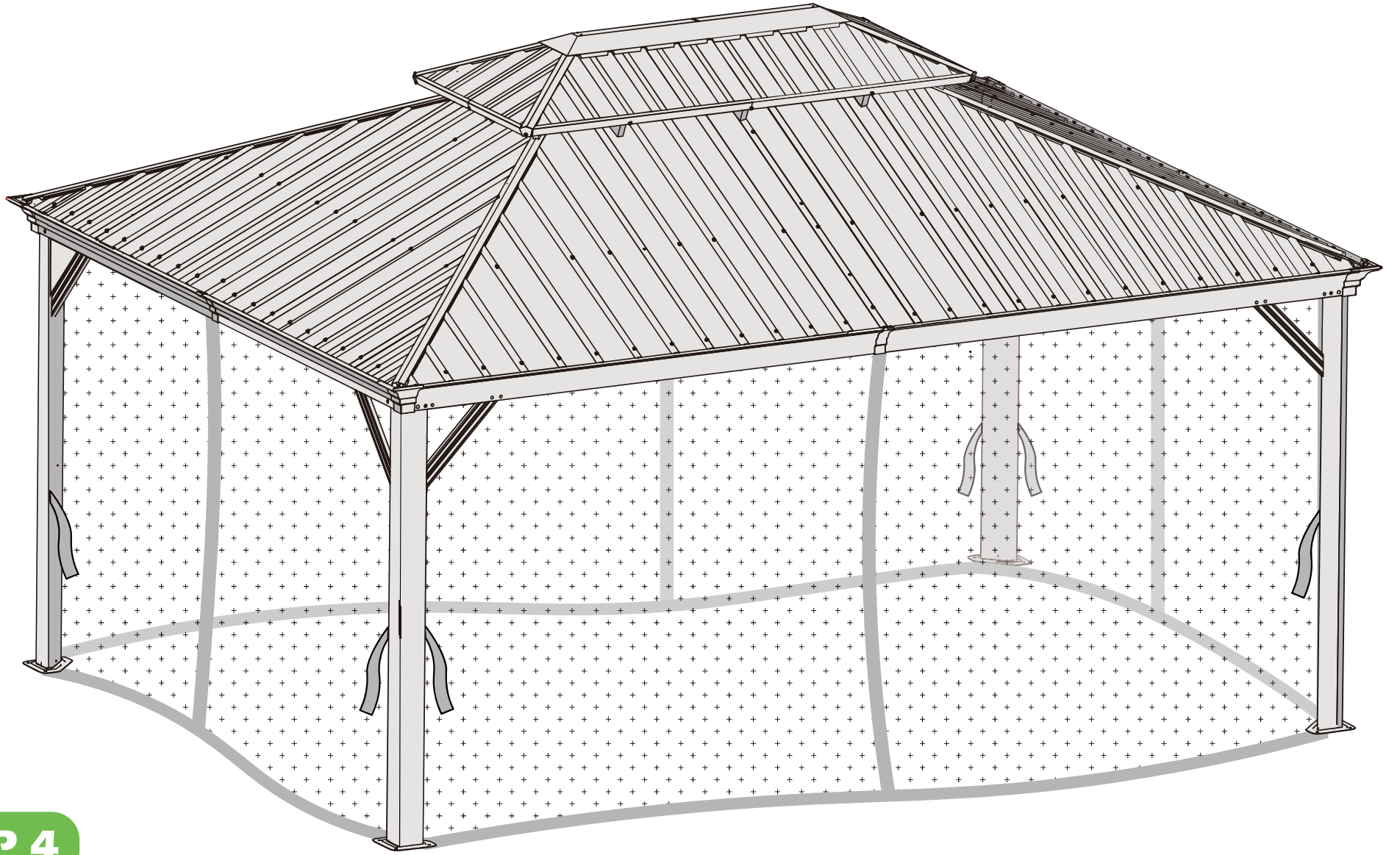

STEP 4

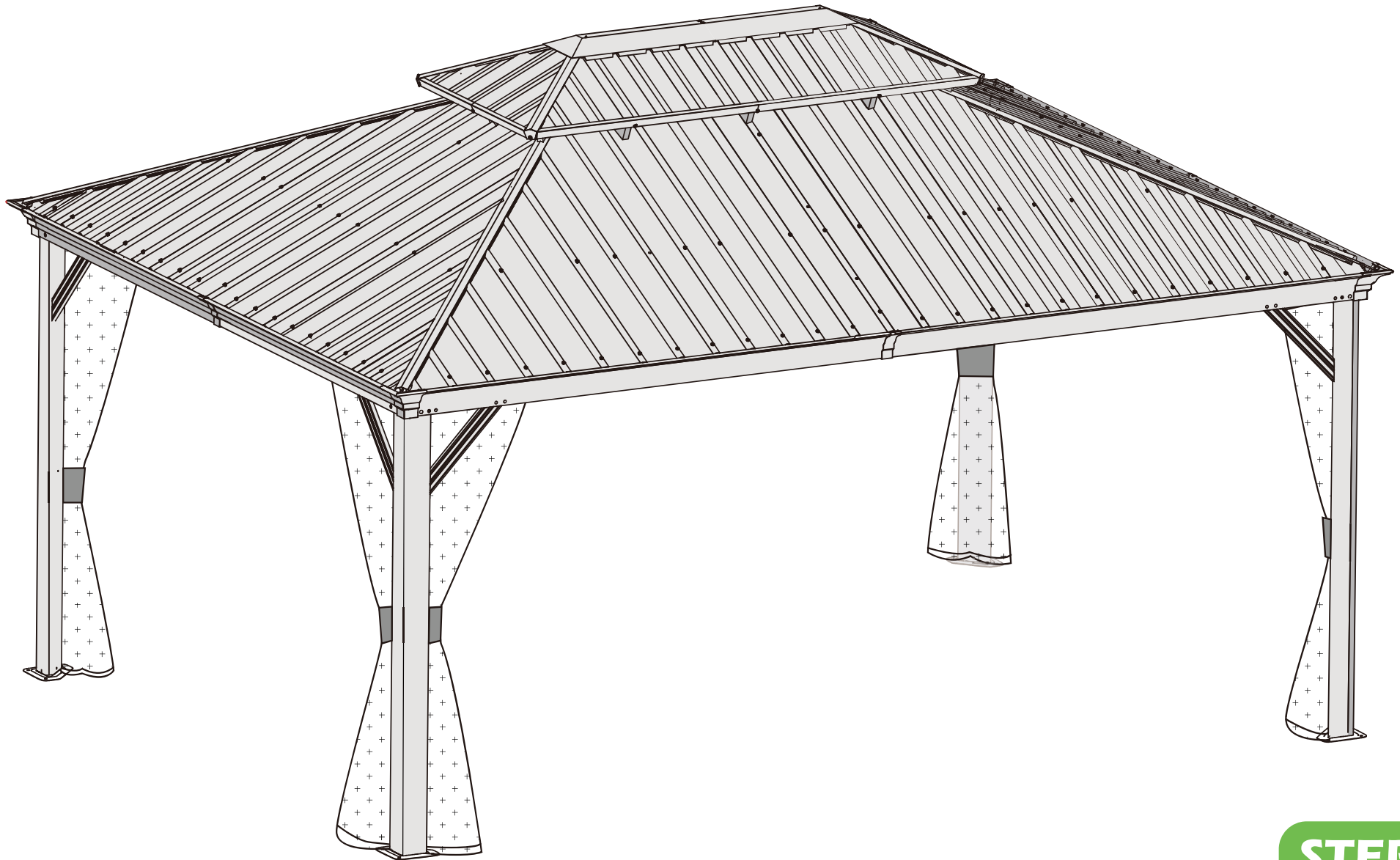

STEP 4

Care and Cleaning

Wash frame parts and fabric with mild soap and water, rinse thoroughly.

Dry frame completely and allow the fabric to drip dry.

Do not use bleach, acid, or other solvents on the fabric or frame parts.

Please inspect and tighten all bolts or fasteners on a regular basis to ensure proper performance and safety of your gazebo.

Warranty

Frames

Frames constructions are warranted to be free from defects in material and workmanship for 1 year from item purchased. Damage to frame from negligence won't be covered by this warranty.

Bolts & nuts

Bolts and nuts are warranted to be free from defects in material and workmanship for 1 year from item purchased. Damage from exposure to chemicals (including not only oils ,spills, fluids) won't be covered by this warranty.

Curtains & Netting

Curtains and netting are warranted to be free from defects in material and workmanship for 1 year from item purchased. Damage from exposure to chemicals (including but not only oils, spills, fluids) won't be covered by this warranty

Warranty Limitation

This warranty is for the original purchase order only. (Order number required). This warranty is non-transferable. Purple Leaf is responsible for the free replacement part including shipping charges for the 1 year warranty.

Warranty Exclusion

This warranty does not cover products subject to negligence, abuse usage, inappropriate installation. Purple leaf reserves the right to explain warranty exclusions. When the replacement item is applied, the 1 year warranty automatically expires. Please feel free to contact us for applying warranty.

Thank you for your purchase of

Domi outdoor living's Gazebo

Read and follow this assembly and operation guide.

To reduce personal injury and damage to your gazebo

Please **close** your gazebo curtain when it is incoming over **30 mph** wind.

We recommend a **two-person team** for assembly and disassembly.

If you like our products, please tell other customers

If you have prbblem with our products, please tell us

Please feel free to contact us.

DOMI OUTDOOR LIVING

domi
outdoor living



RESORT COMFORT IN YOUR
OWN BACKYARD

Support:



Email: domiservice01@outlook.com

Please tell us your order ID when contact.

Attach photos of damaged part for instant reply.