



## **Warnings and Cautions**

*Please retain this instruction for future usage and read carefully before assembly.*

*Make sure you have all the parts & hardware as item list shows.*

***2 adults or more** are recommended to install your gazebo.*

*Do not discard any of the packaging until you have checked that you have all the parts and pack of fittings.*

*Check all bolts for tightness before use, and periodically check and tighten bolts ensure your gazebo works properly.*

*Some parts might have sharp edges/corners. Please follow basic safety precautions to reduce the risk of hurts.*

*Maximum weight capacity is **1000 pounds**.*

*It is essential to place the gazebo on level ground and not less than **6 feet** from any obstruction such as fences, garages, the house, overhanging branches, laundry lines, or electrical wires.*

*If you have questions or concerns.*

*Please contact us via email at **domiservice01@outlook.com***

# Domi outdoor living

domi  
outdoor living



**12'x20'**

SKU:LGMF8223A

HARDTOP GAZEBO  
WITH DOUBLE ROOF

**Assembly Manual**

**T**hank you for your purchase of

*Domi outdoor living's Gazebo*

Read and follow this assembly and operation guide.

To reduce personal injury and damage to your gazebo

Please **close** your gazebo curtain when it is incoming over **30 mph** wind.

We recommend a **two-person team** for assembly and disassembly.

If you like our products, please tell other customers

If you have prbblem with our products, please tell us

**Please feel free to contact us.**

**DOMI OUTDOOR LIVING**

**domi**  
outdoor living

## Pre-assembly

### TOOLS THAT MAY BE REQUIRED (Not included in boxes)

\*NOTE: Tools / equipment are not shown to actual size and scale.



LEVEL

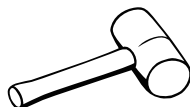

RUBBER Mallet



PHILLIPS SCREW



DRILL

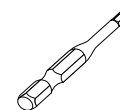

ALLEN KEY

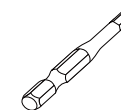

ALLEN KEY

### EQUIPMENT REQUIRED (Not included in boxes)

\*NOTE: Equipment are not shown to actual size and scale.



SAFETY HAT



GLOVES



SAFETY GOGGLES



STEPLADDER

### Matters needing attention



1. Two or more people are required for assembly.



2. Do not fully tighten screws prior to complete assembly.

# MOUNTING BLUEPRINT

## Gazebo 12×20

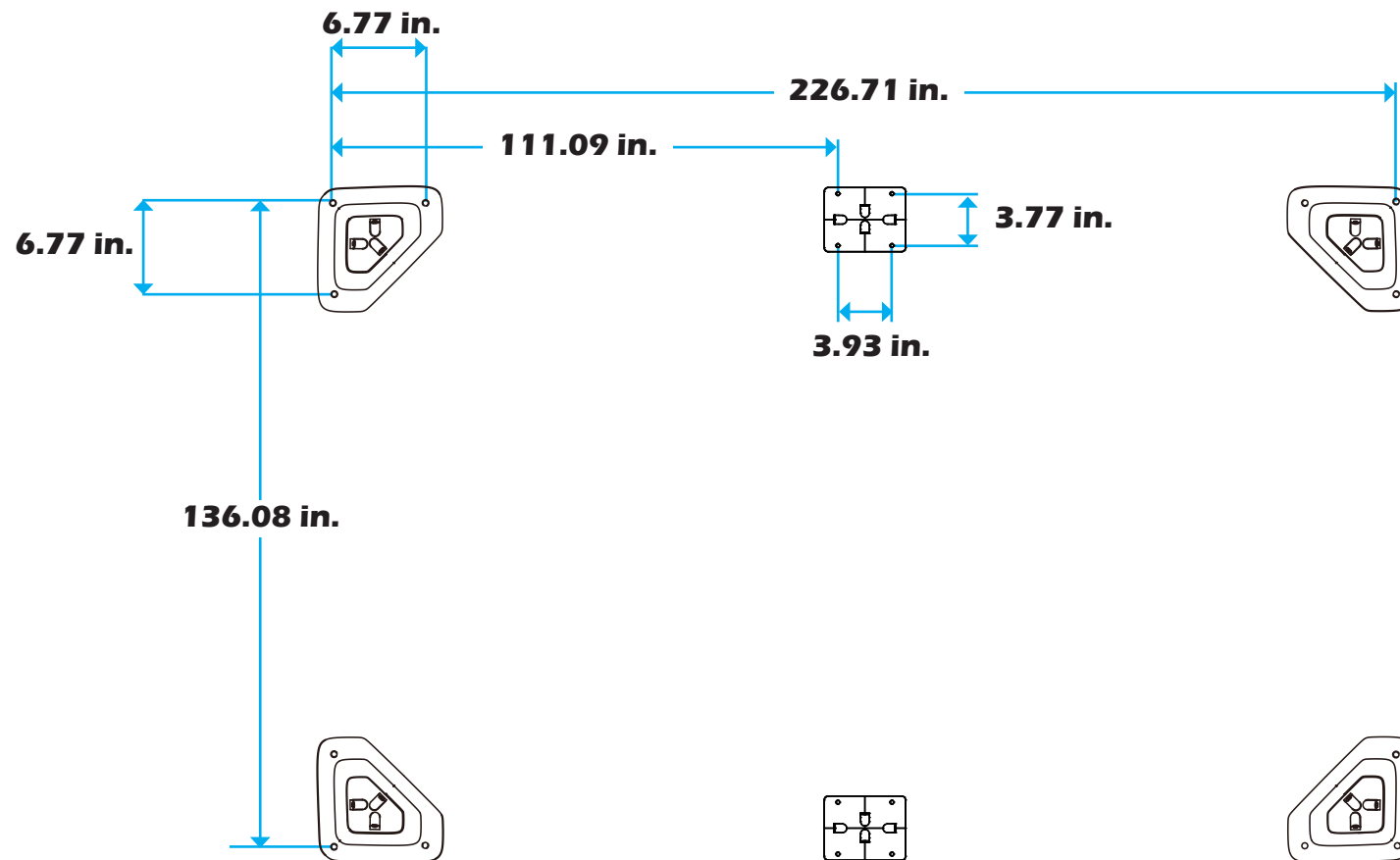

1

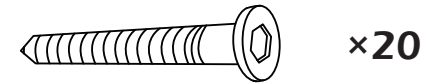
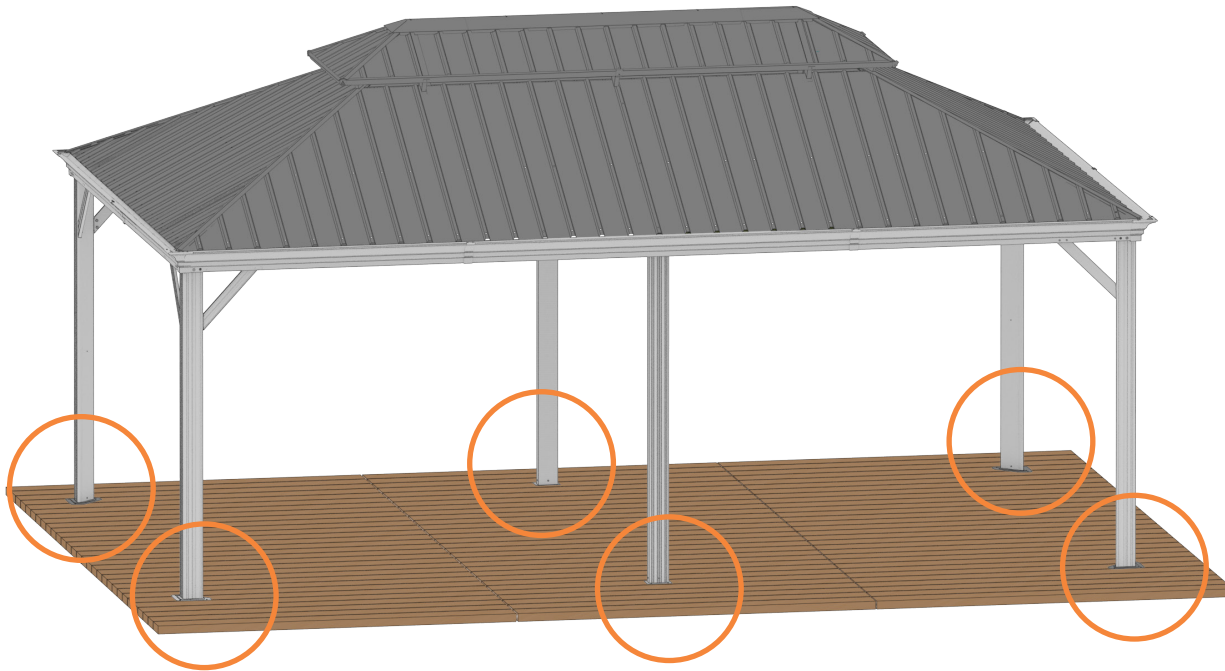

If the deck is hard wood and the depth of it is over 3 inch , you can use **5/16 in. x4 in. Structural Wood Screw** to mount the gazebo.

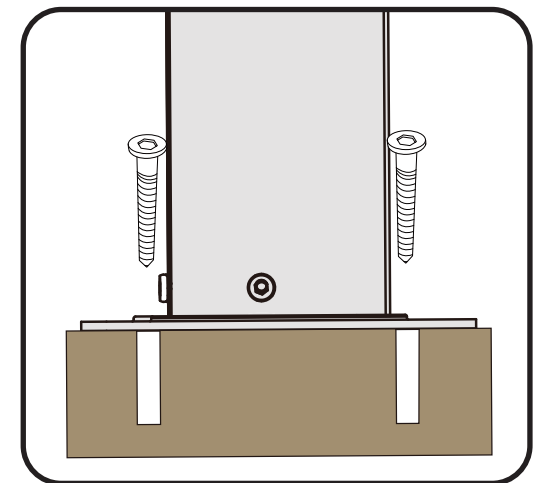
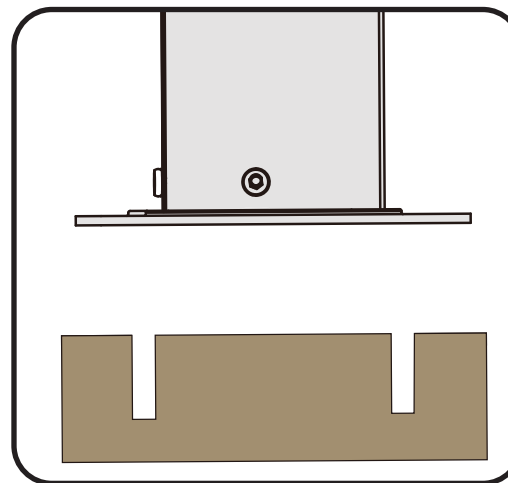

2

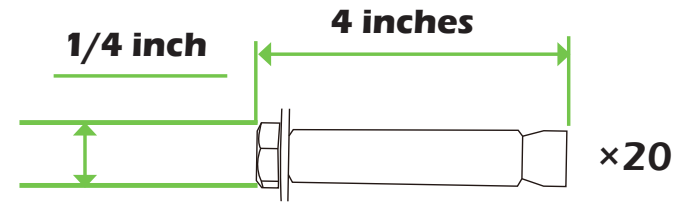
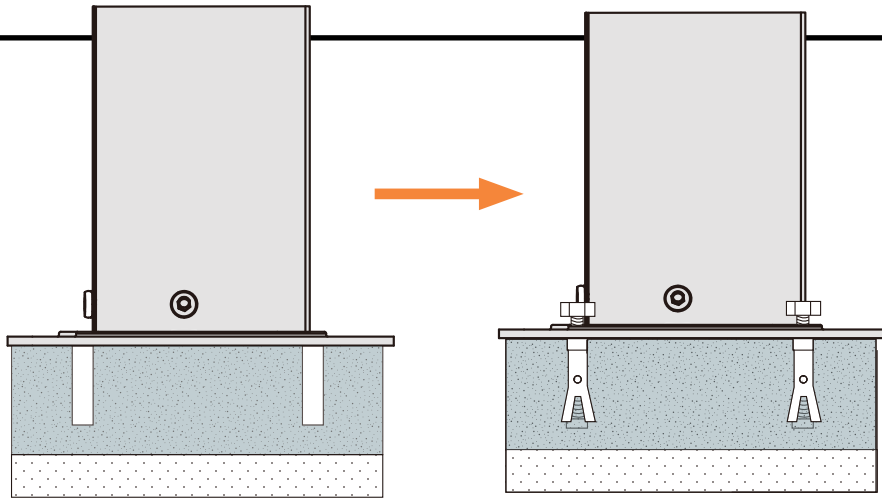

If the ground is concreted and the depth of it is over 3 inch, you can use 1/4 inch expansion bolts to mount the gazebo

3

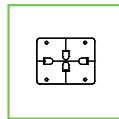
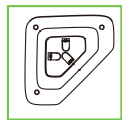

Or you can make a concrete footing for gazebo, **15×15×15 inches** is recommended. use expansion bolts to mount the gazebo like ② shows.

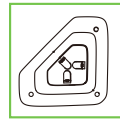
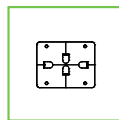
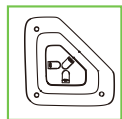

**IMPORTANT:**  
Anchor is not recommended

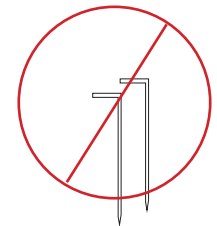

# CHECK LIST

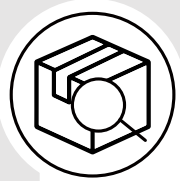

**A** × 4



**B** × 2

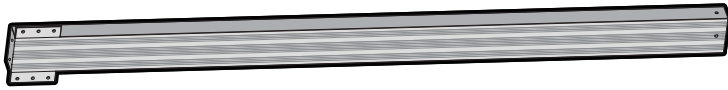

**C** × 4

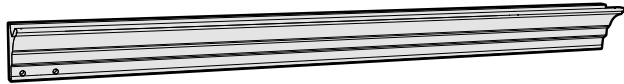

**C1** × 4



**C2** × 2

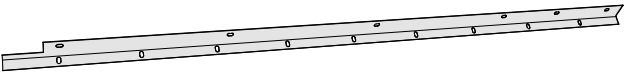

**C3** × 2



**D** × 4



**D1** × 4



**D2** × 2

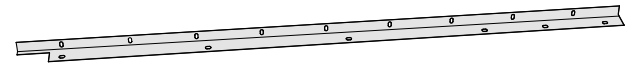

**D3** × 2

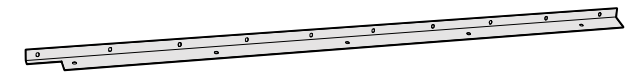

**E** × 2

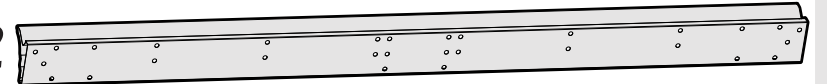

**E1a** × 2

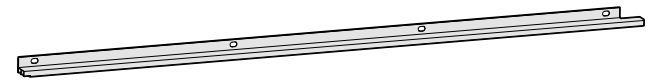

**E2a** × 2

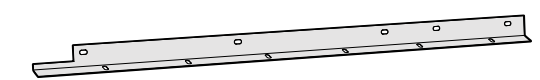

**E1b** × 2

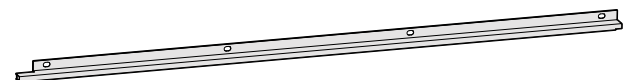

**E2b** × 2

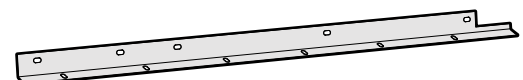



**F** × 6

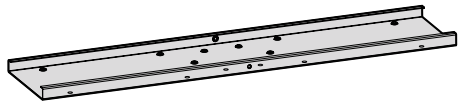

**G** × 4

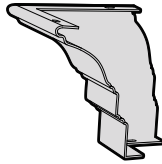

**H** × 6

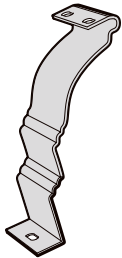

**H1** × 6

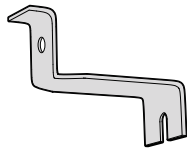

**H2** × 1

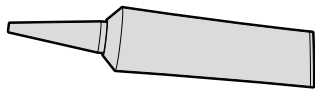

**J1** × 4



**J2** × 4



**K** × 1

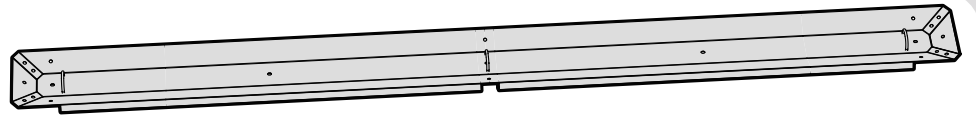

**K1** × 1

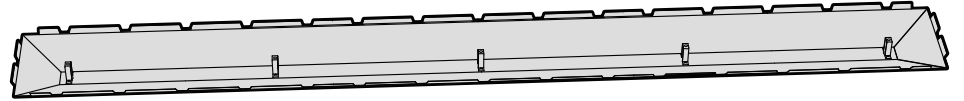

**L** × 4

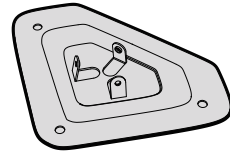

**L1** × 2

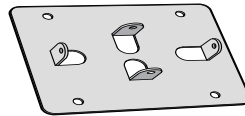

**M** × 4



**N** × 2



**N1** × 4



**N2** × 2

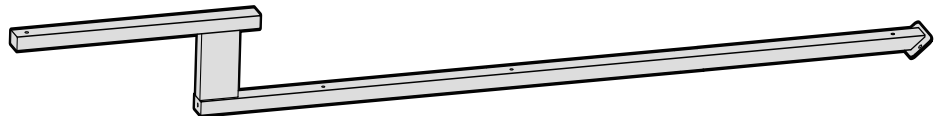

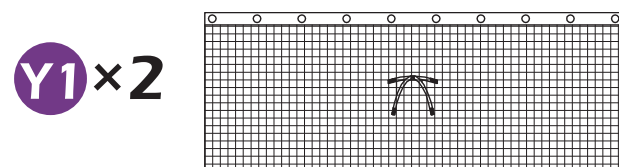
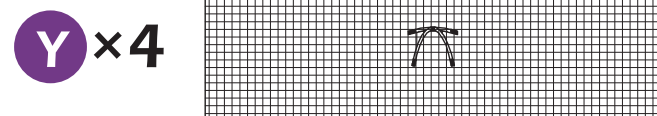
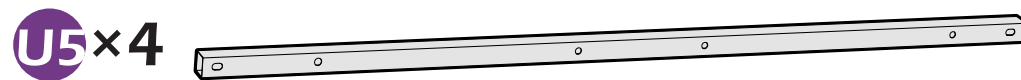
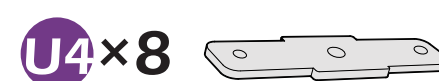
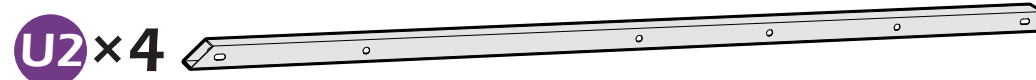
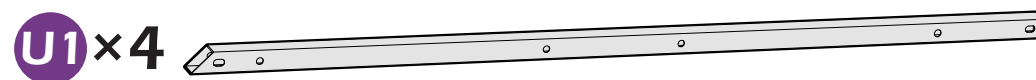
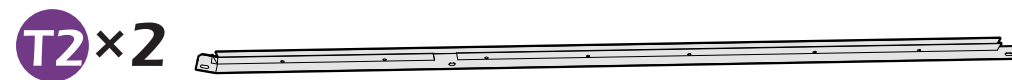
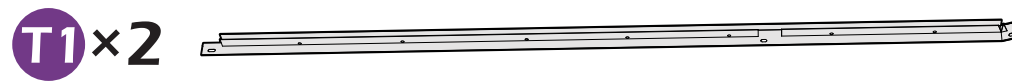
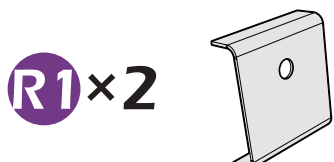
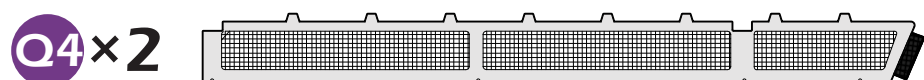
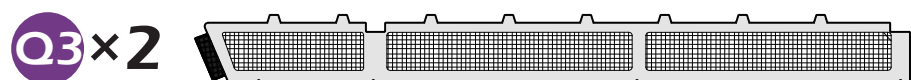
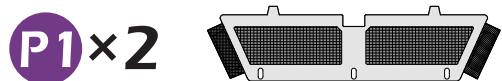
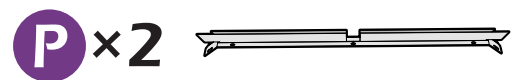

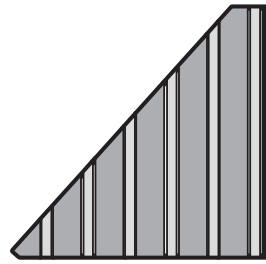

**V1×2**

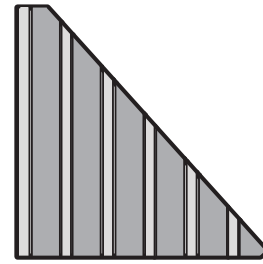

**V2×2**

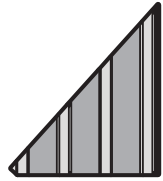

**V3×2**

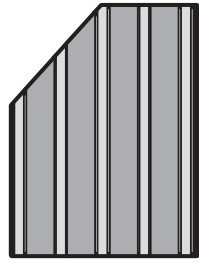

**V4×2**

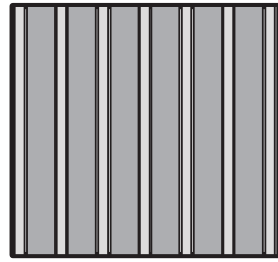

**V×8**

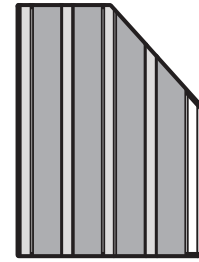

**V5×2**

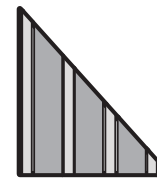

**V6×2**



**W1×2**

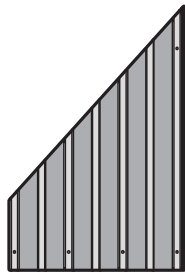

**W2×2**

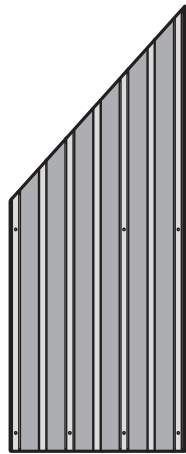

**W3×2**

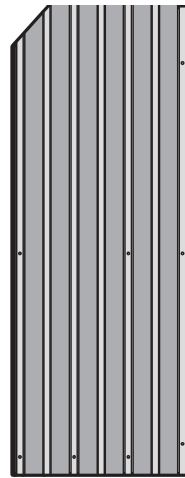

**W4×2**

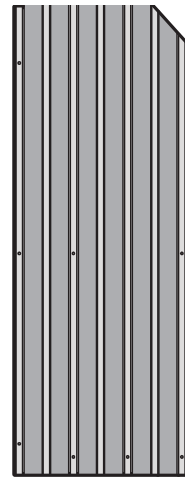

**W5×2**

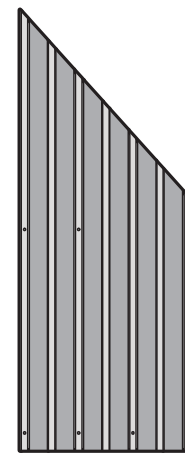

**W6×2**

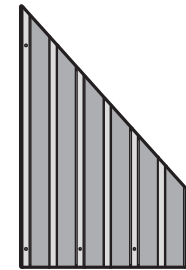

**W7×2**



**W8×2**

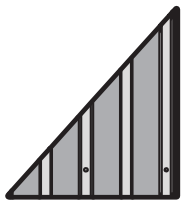

**X1**×2

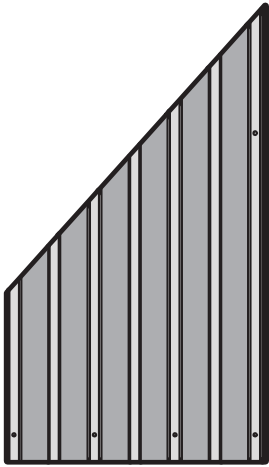

**X2**×2

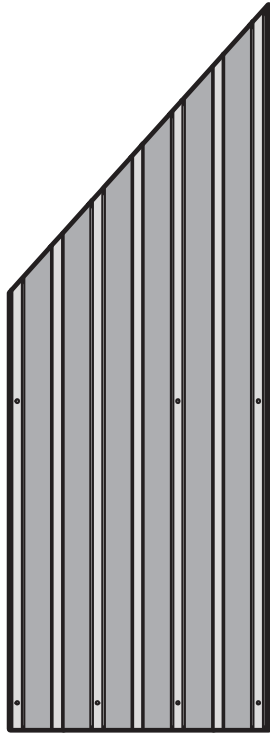

**X3**×2

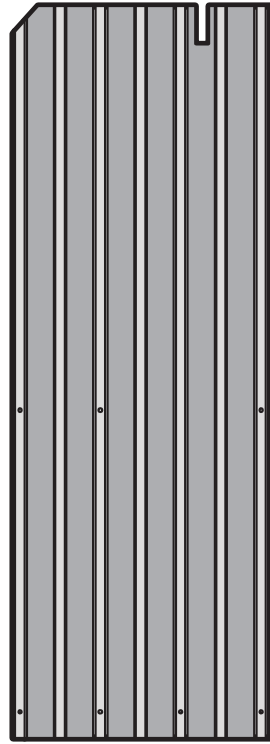

**X4**×2

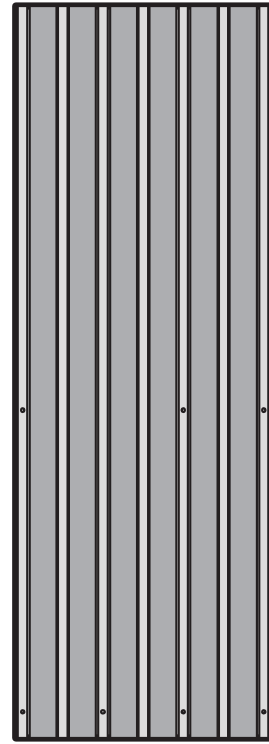

**X5**×2

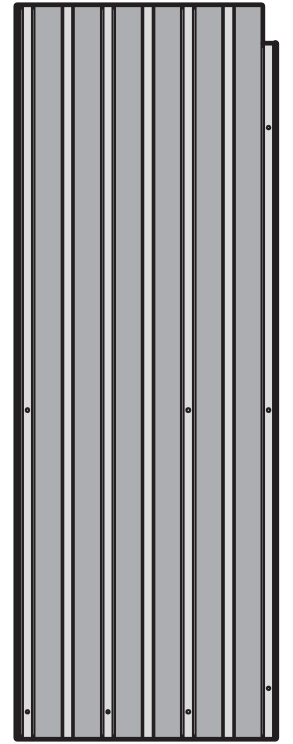

**X6**×2

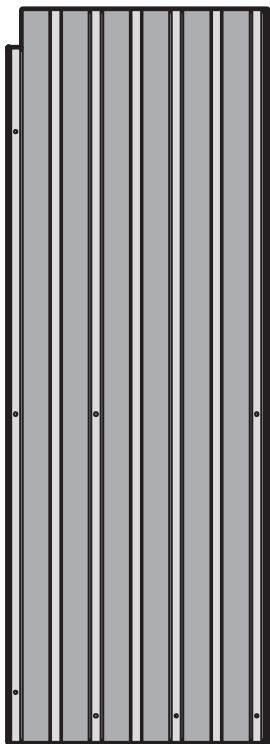

X7×2

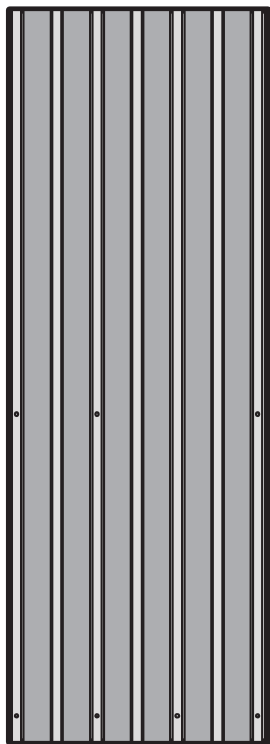

X8×2

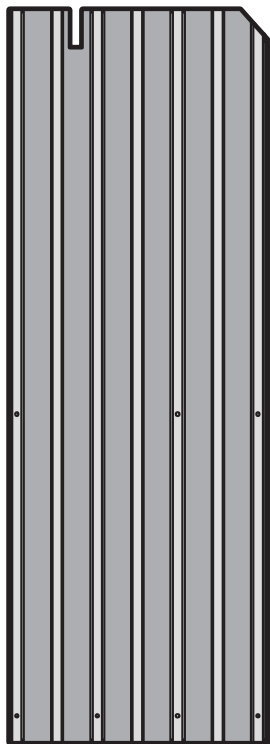

X9×2

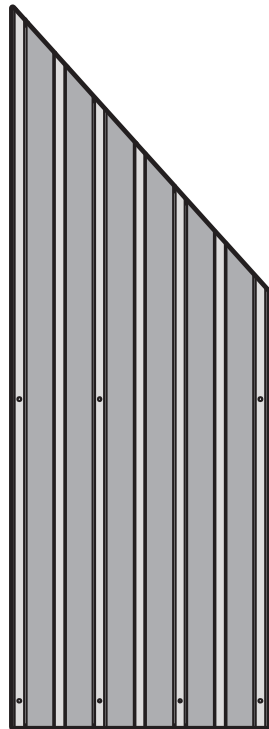

X10×2

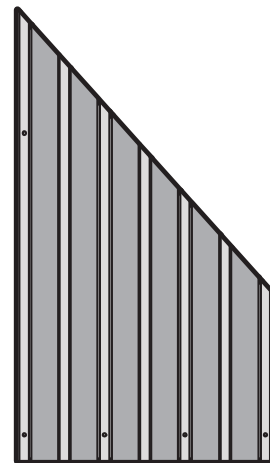

X11×2

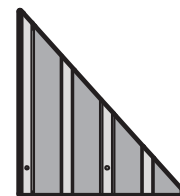

X12×2

**Z**×72



**4#**×152

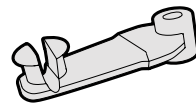

**10#**×4

(M6×25)

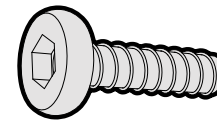

**Z1**×6



**5#**×100

(M6×28)

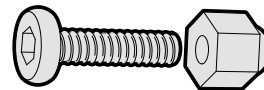

**11#**×12

(M6×10)

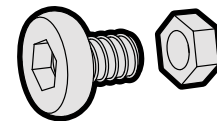

**Z2**×6



**Z3**×2



**6#**×8

(M6×45)

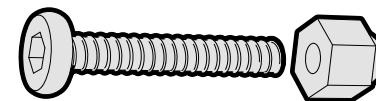

**12#**×1

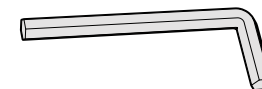

**Z4**×2



**7#**×48

(M6×50)

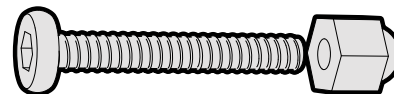

**14#**×1

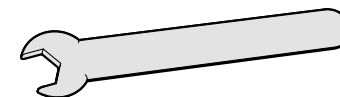

**1#**×301

(M6×16)

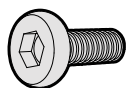

**8#**×6

(M5×16)

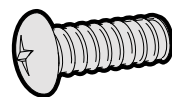

**15#**×1

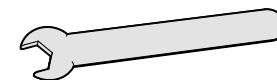

**2#**×28

(M6×20)

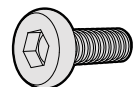

**3#**×16



**9#**×28

(ST4.8×13)

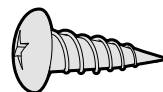

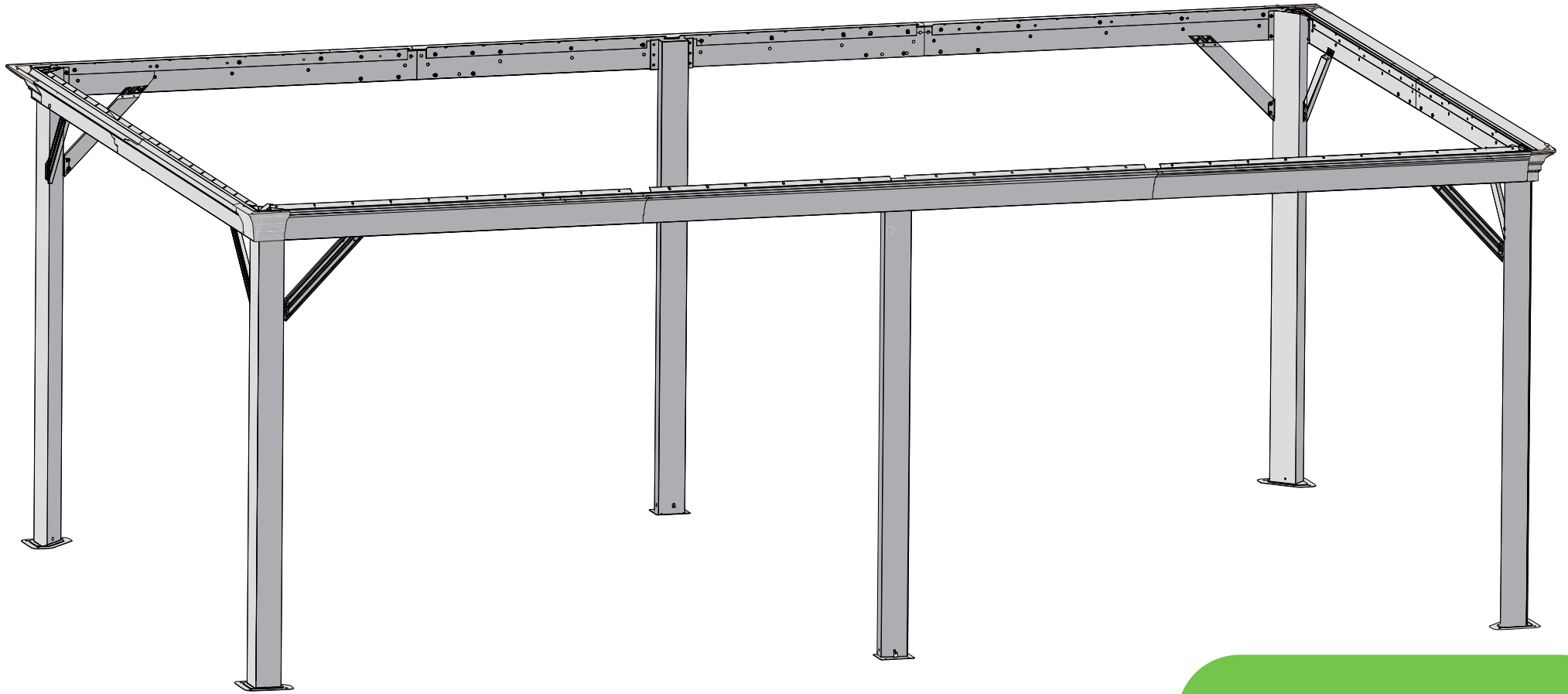

**STEP 1**

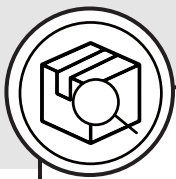

**A** × 4

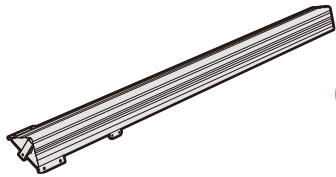

**L** × 4

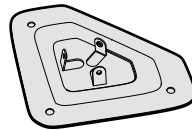

**1#** × 12

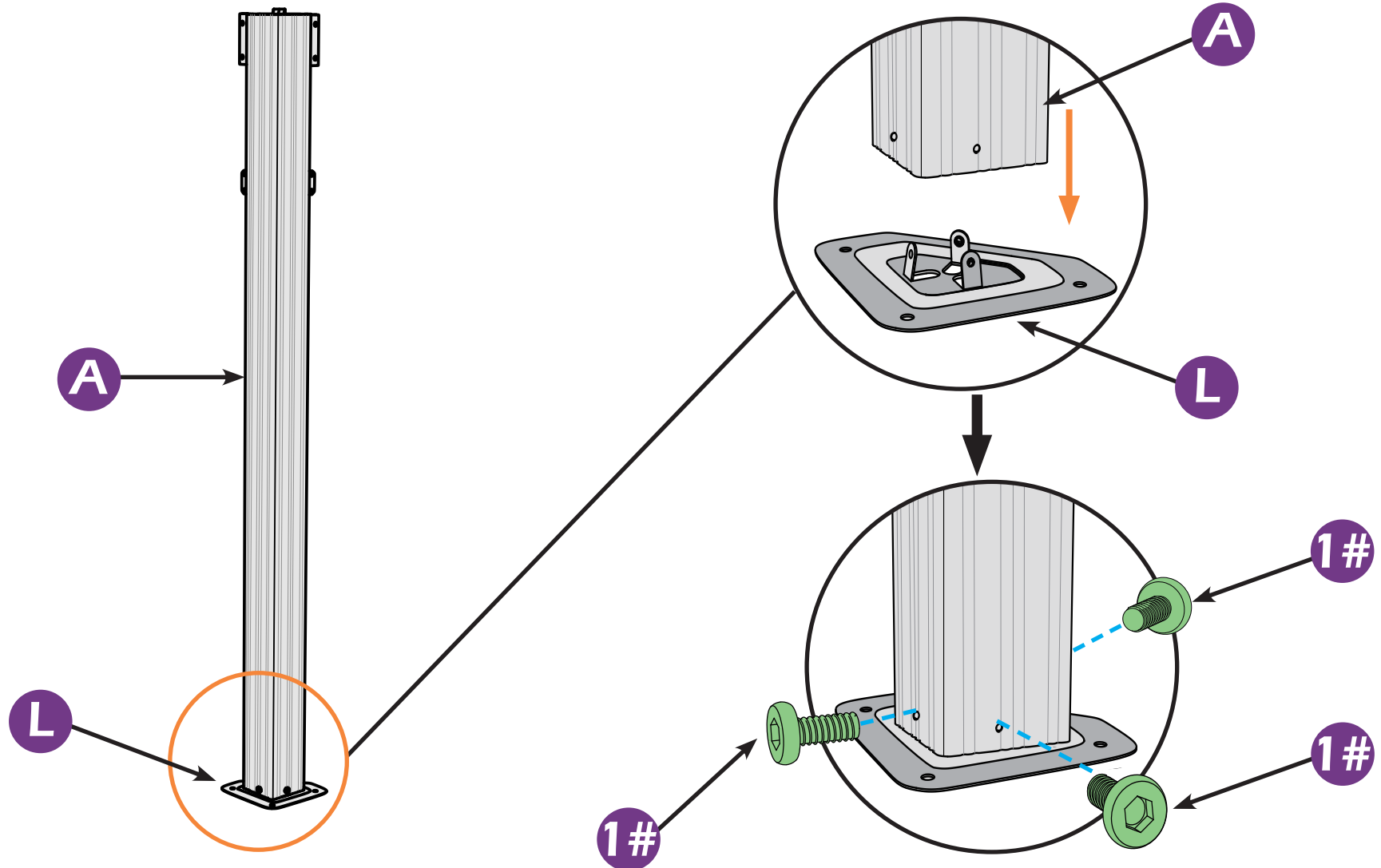
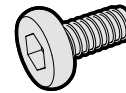

**STEP 1**



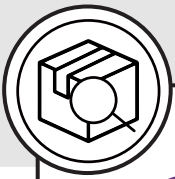

**B** × 2

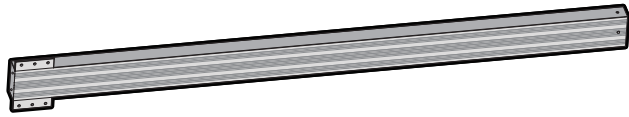

**L1** × 2

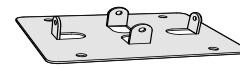

**1#** × 8

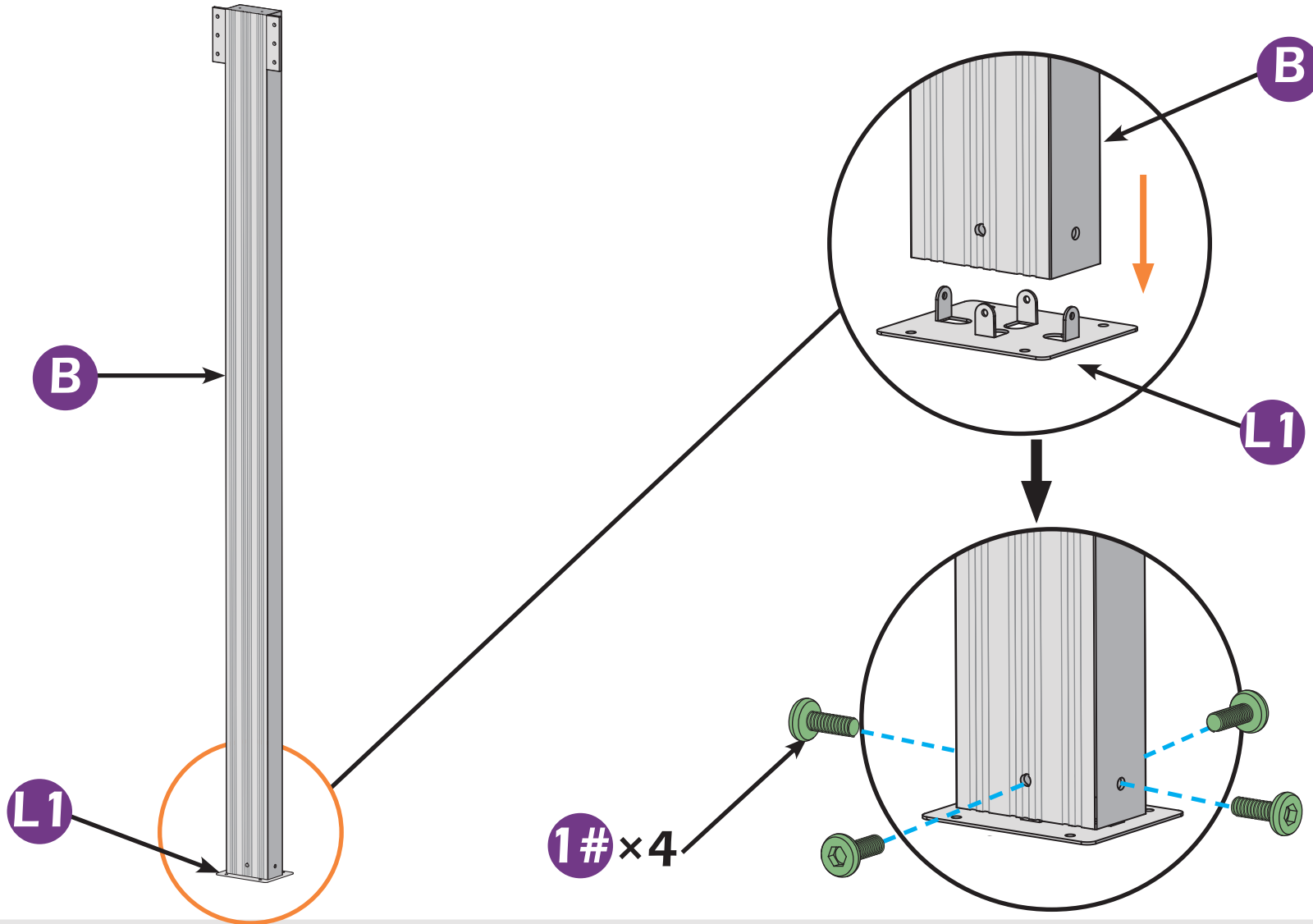
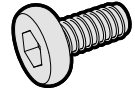

**STEP 1**



**C** × 2

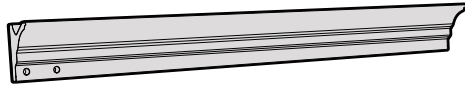

**F** × 2

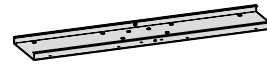

**D** × 2

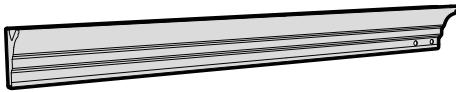

**1#** × 8

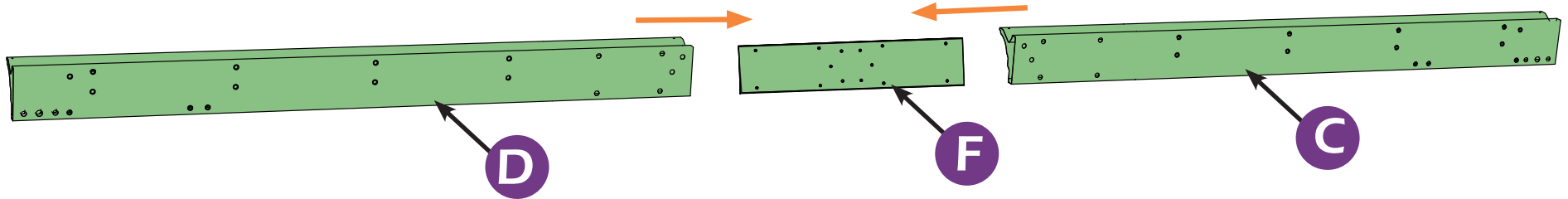
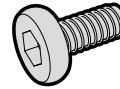

**STEP 1**

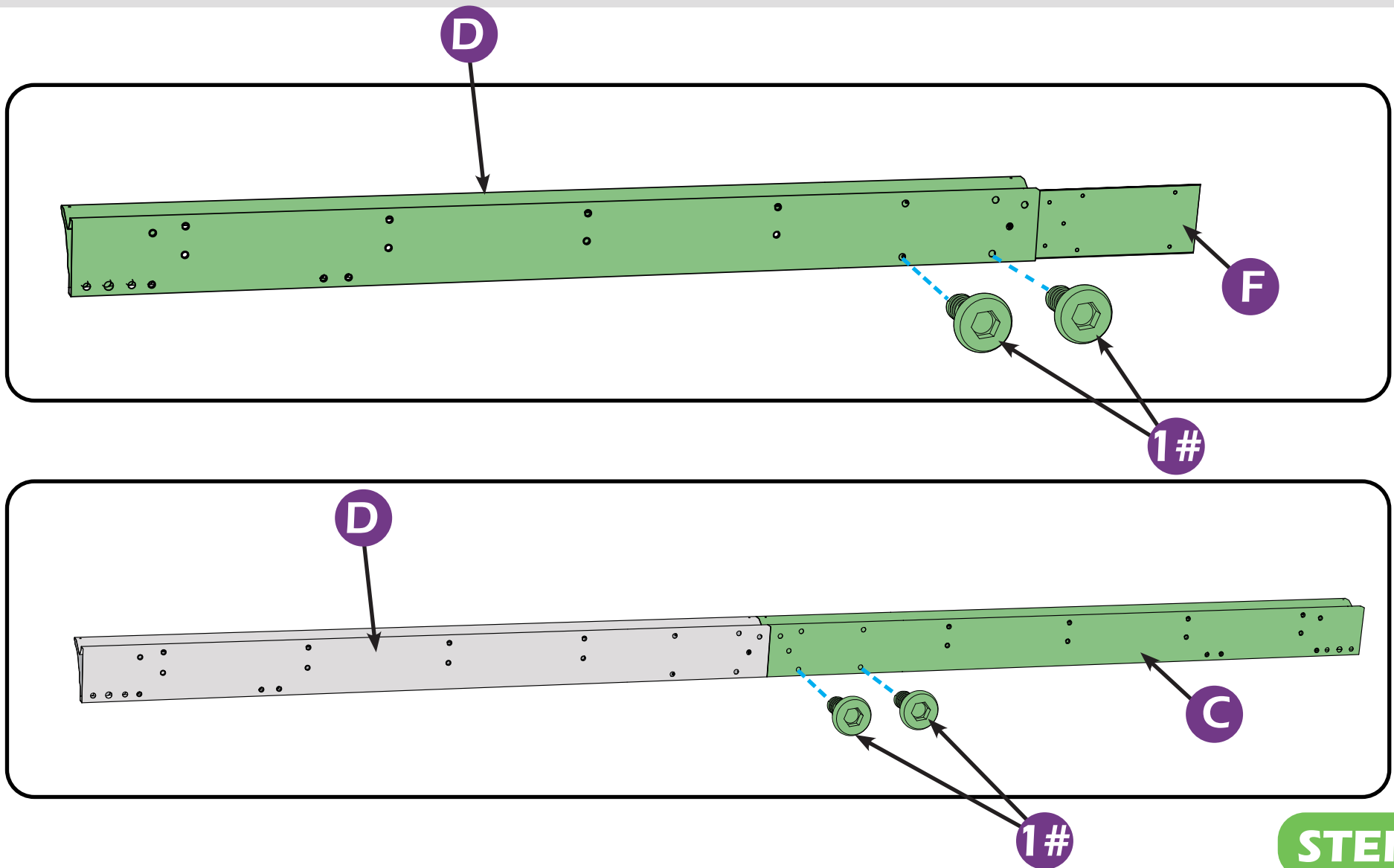

**STEP 1**

▲ It's a normal situation that there's a gap between the 2 beams, please use silicone sealant (part #H2) and bracket #H to affix the gap.(see P56-57)

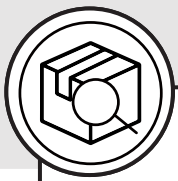

D2 × 2

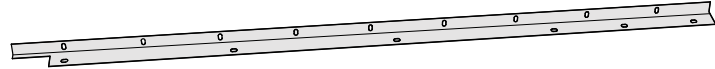

1# × 24

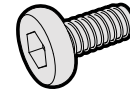

C2 × 2

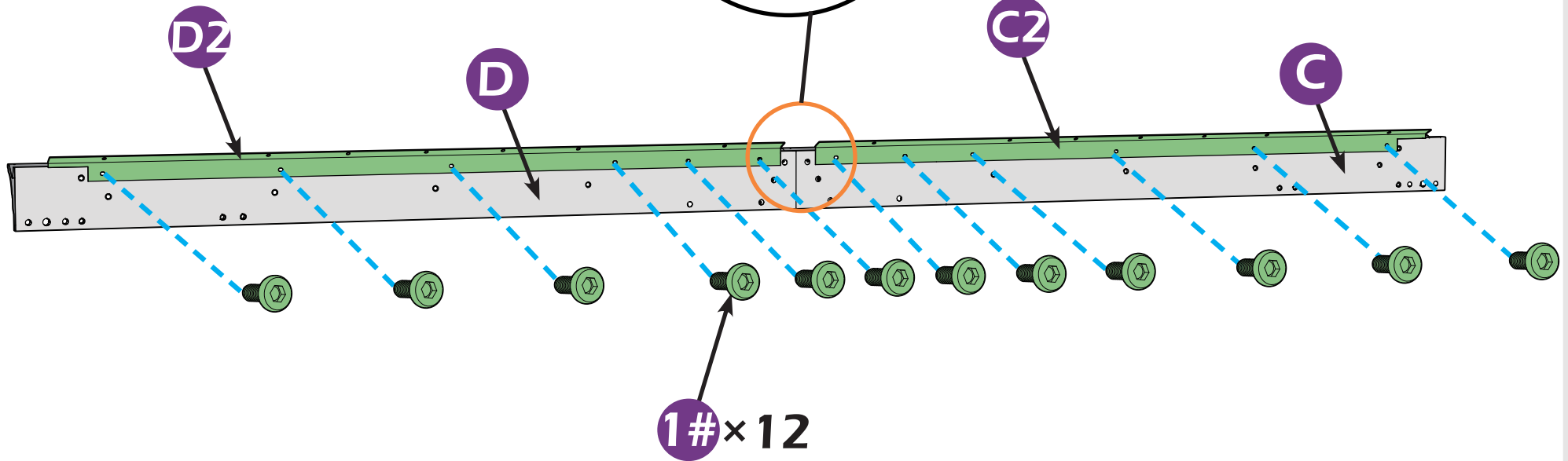
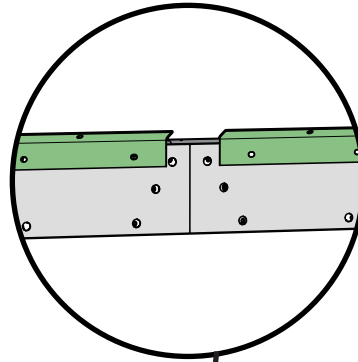
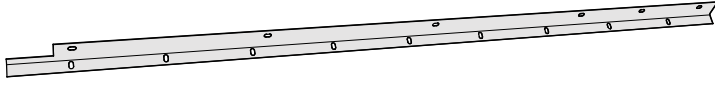

**STEP 1**



**C** × 2



**F** × 4

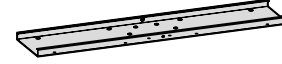

**D** × 2



**1#** × 16

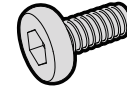

**E** × 2

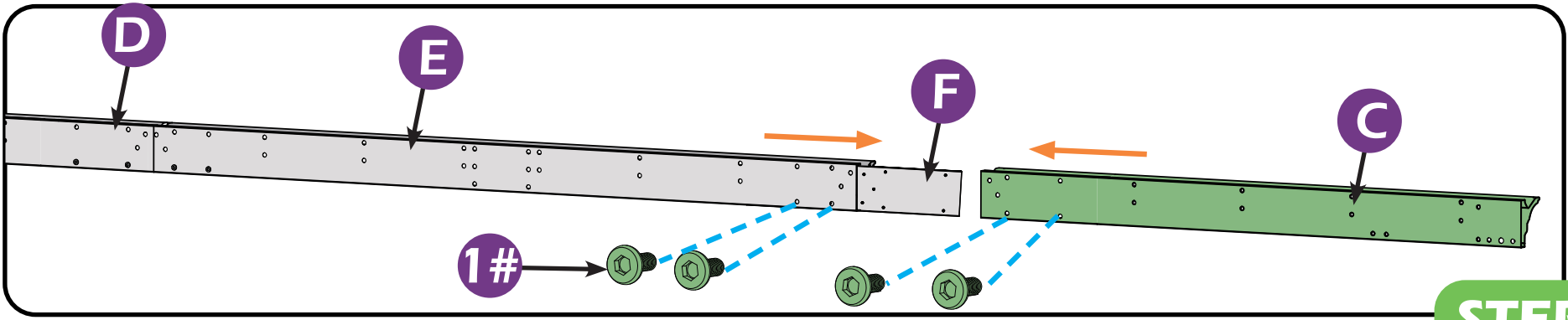
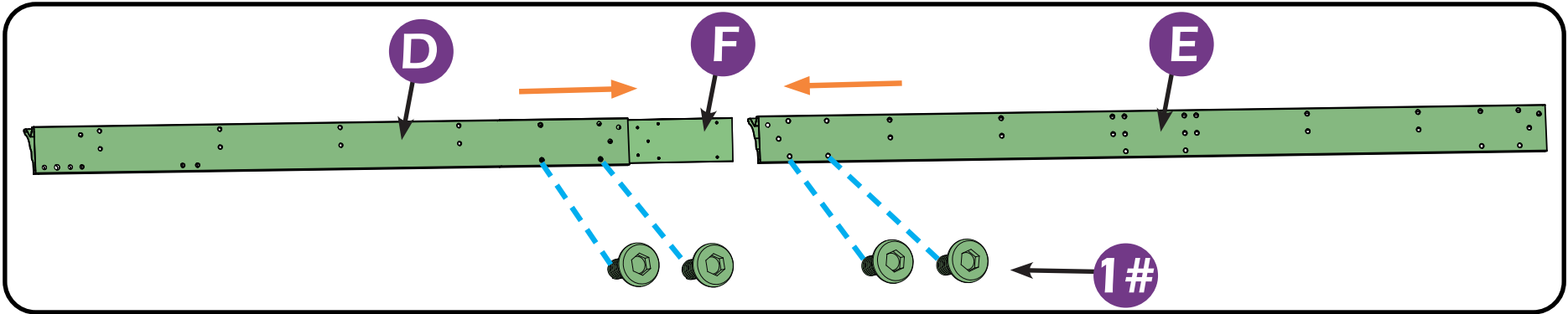
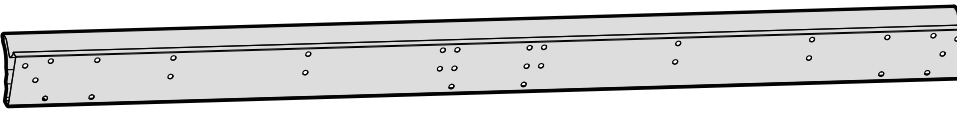

**STEP 1**

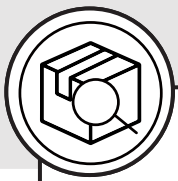

D3 × 2

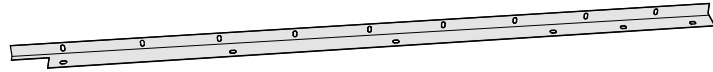

1# × 44

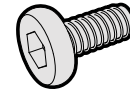

C3 × 2

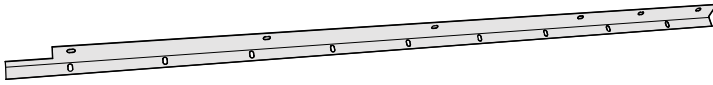

E2a × 2

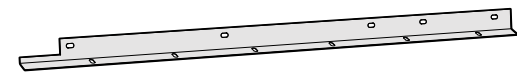

E2b × 2

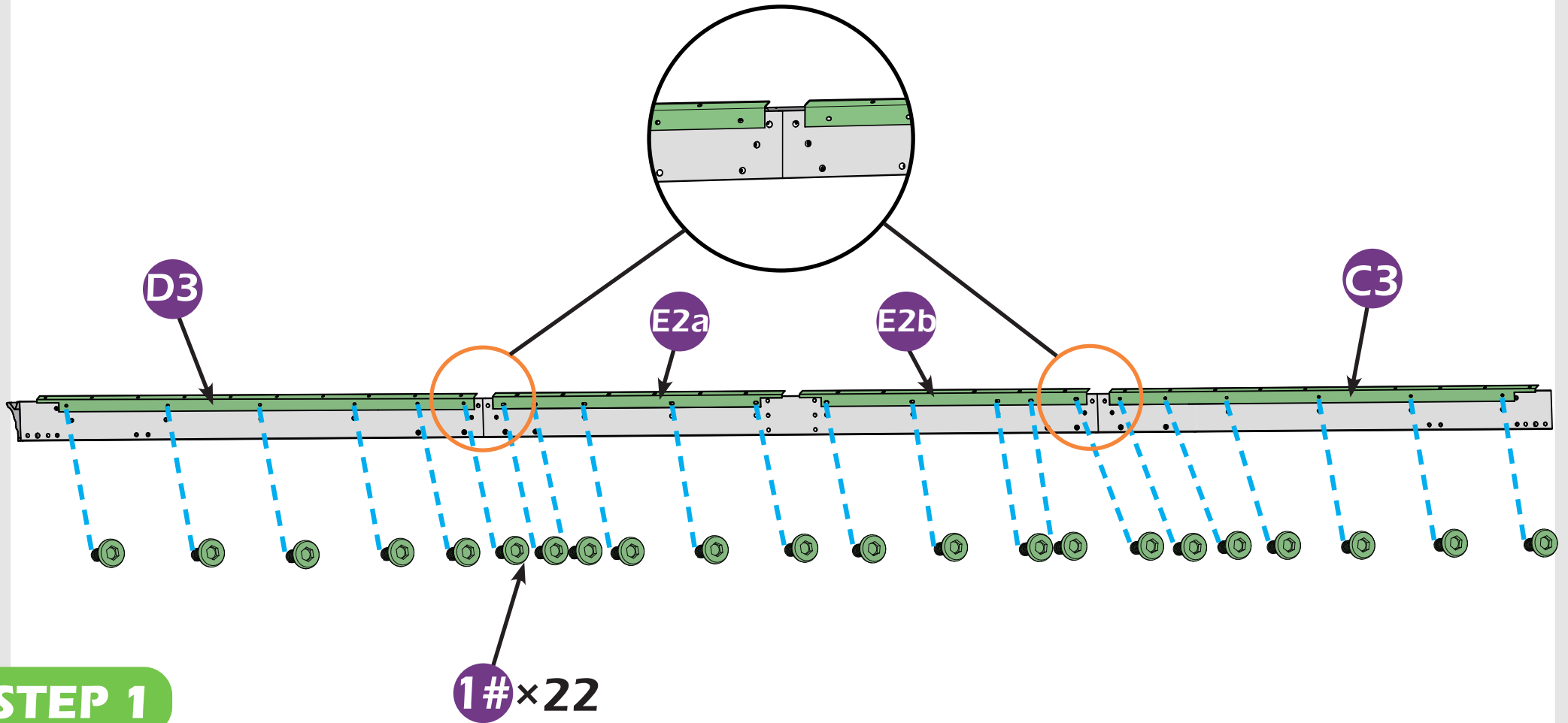
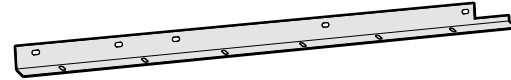

**STEP 1**

1# × 22

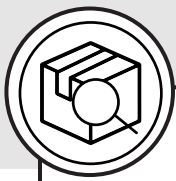

2# × 28

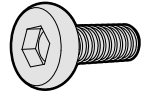

3# × 16

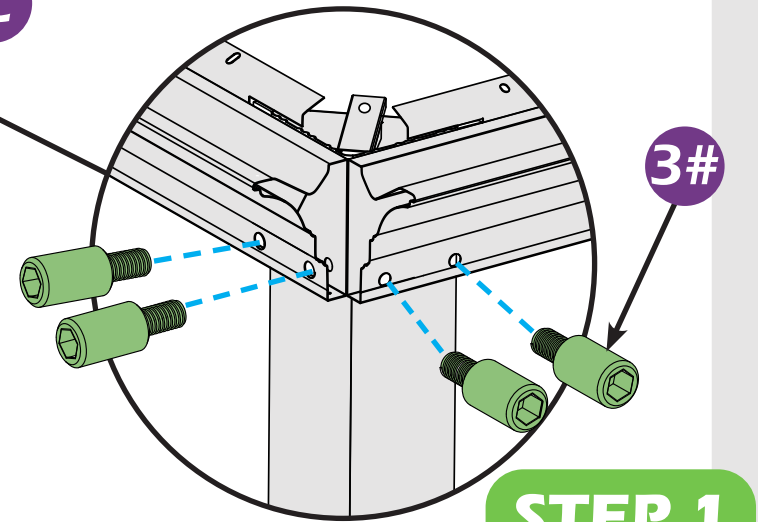
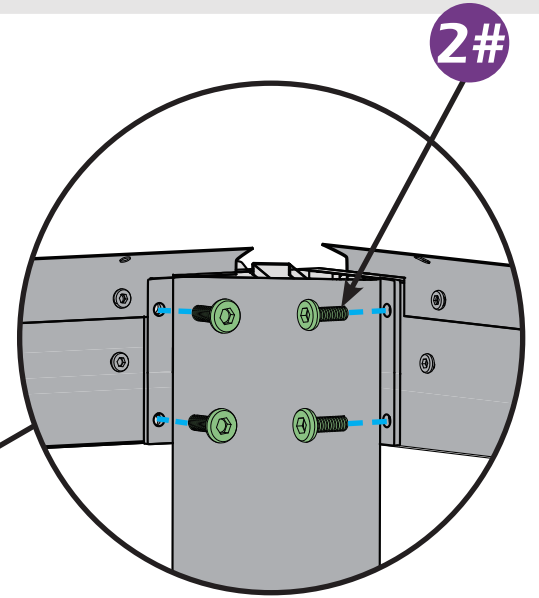
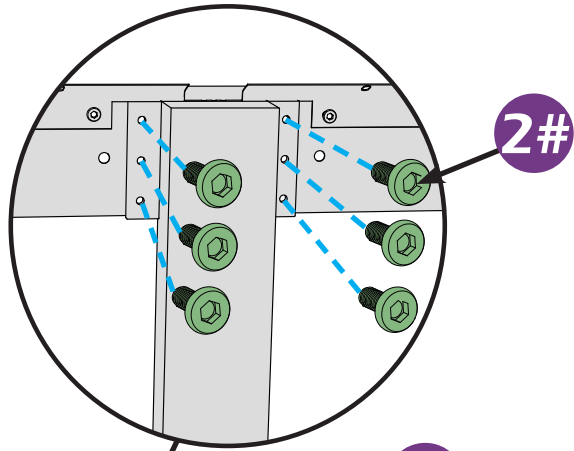
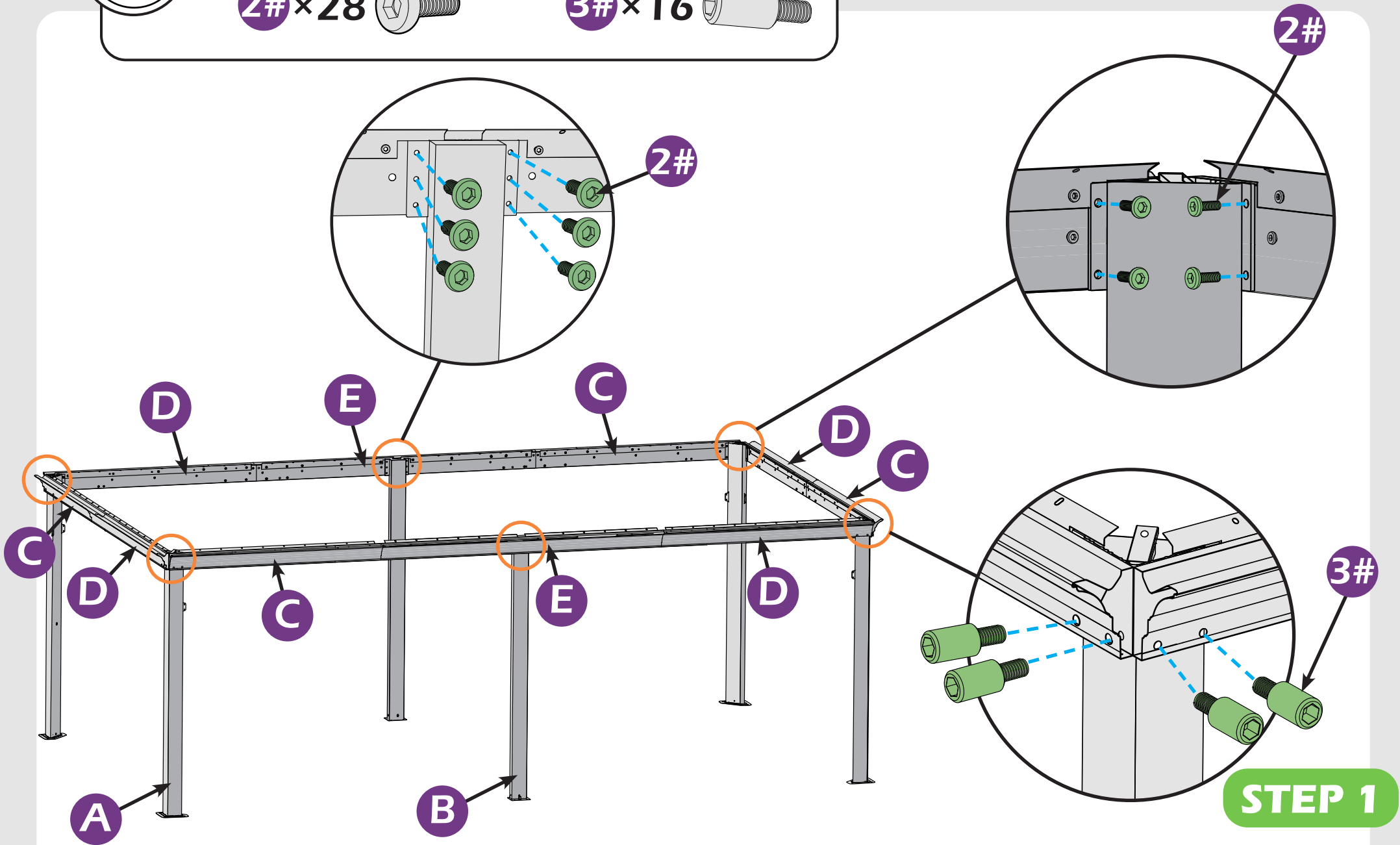
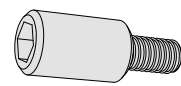

**STEP 1**

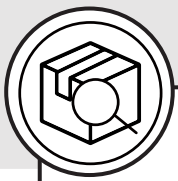

**J1** × 4



**1#** × 32

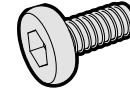

**J2** × 4

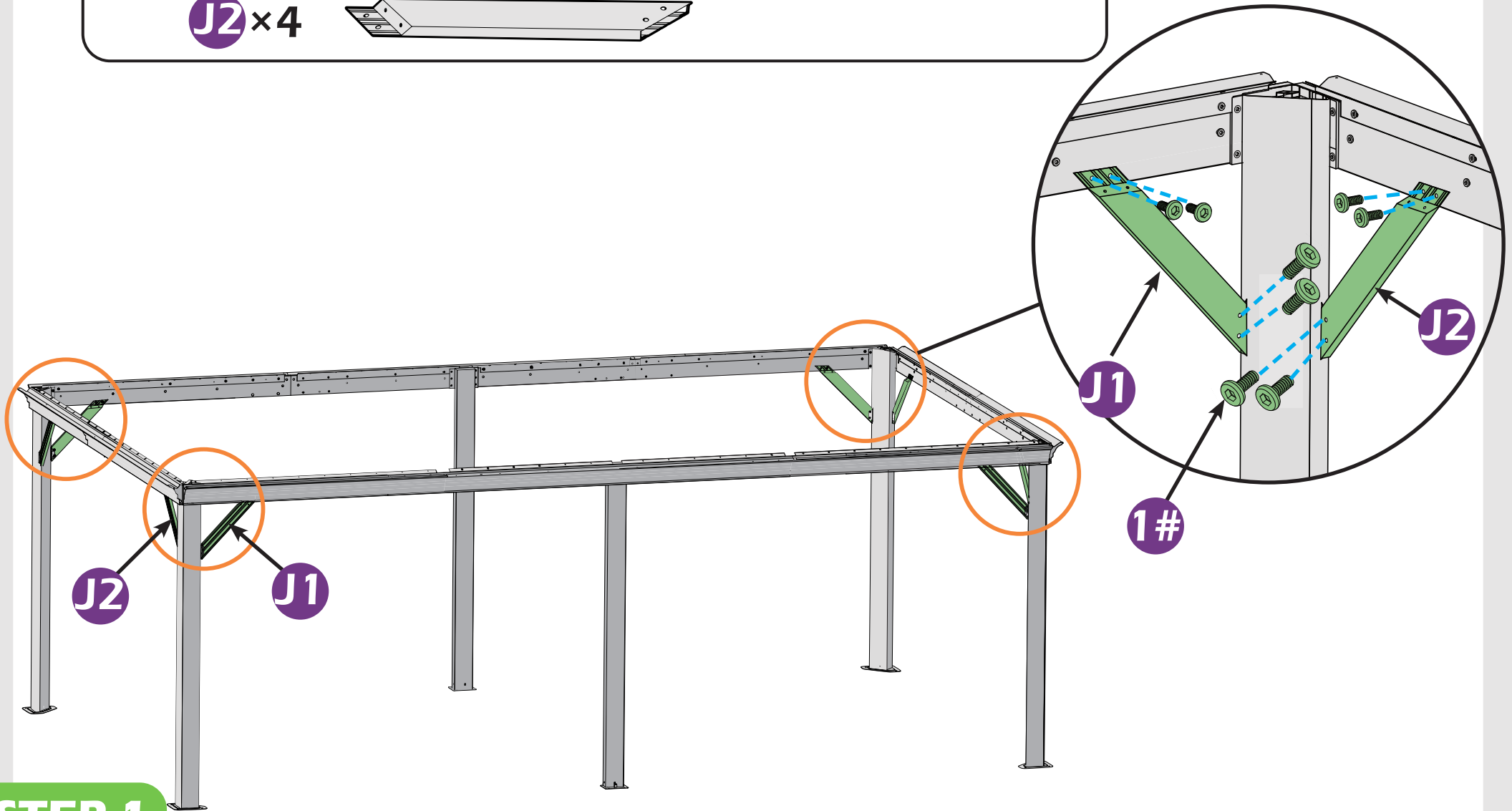

**STEP 1**



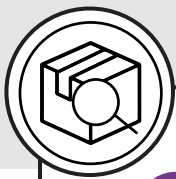

**G** × 4

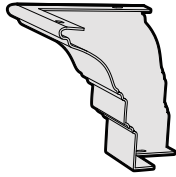

**9#** × 16

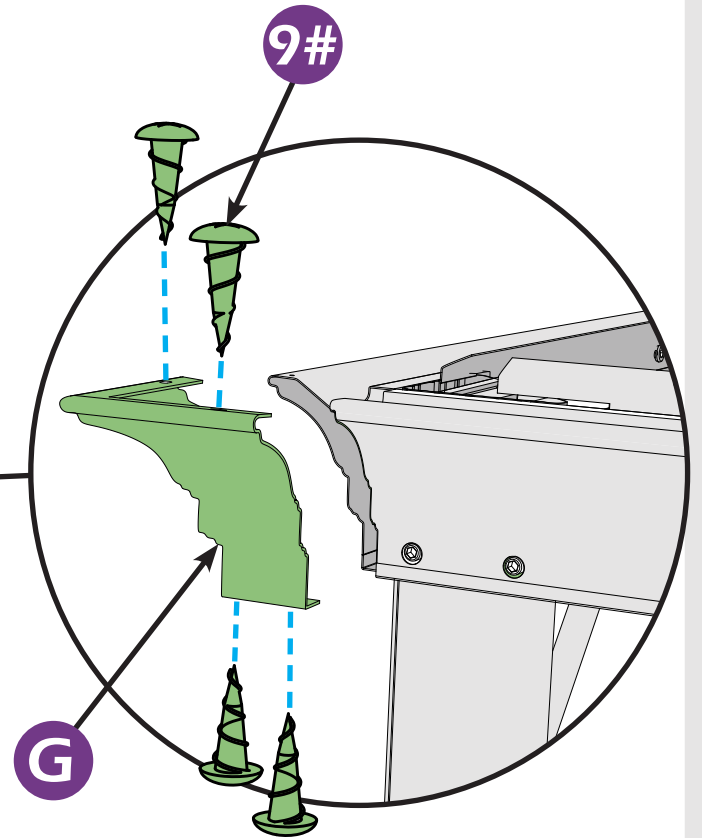
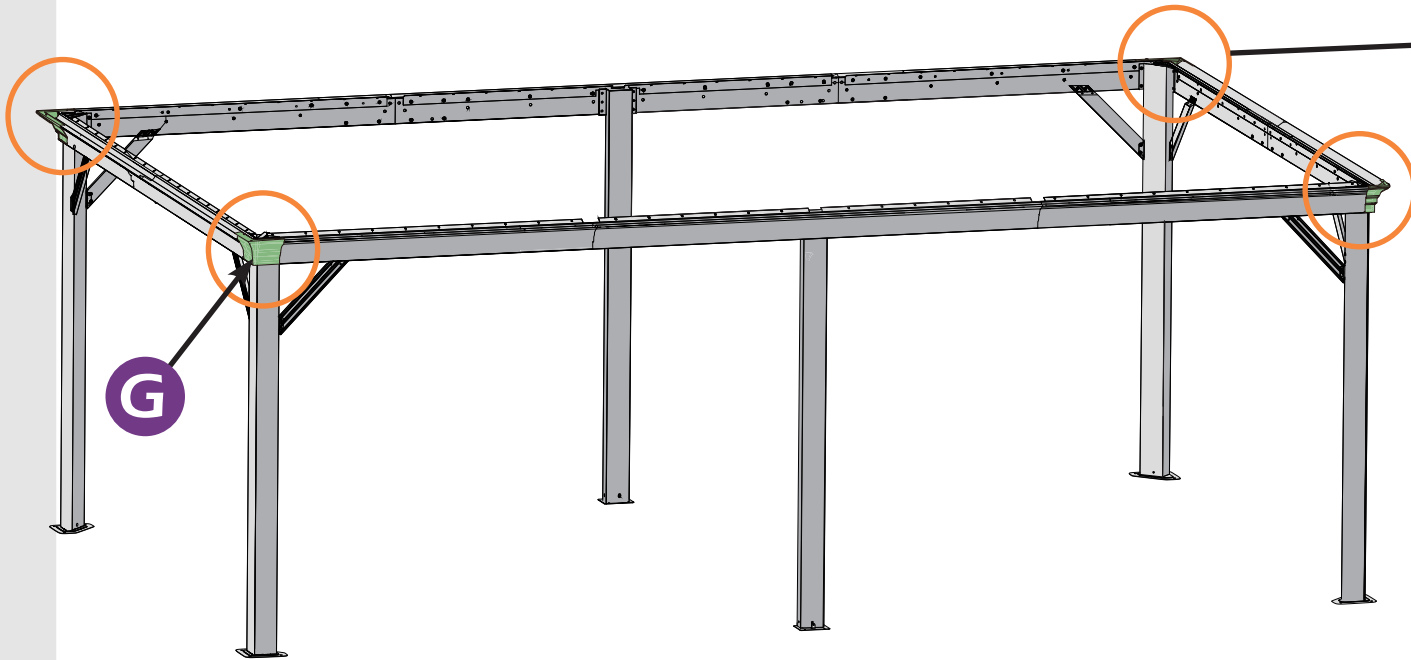
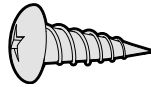

**STEP 1**



**STEP 2**

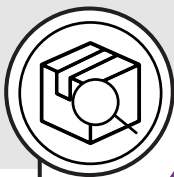

**K** × 1

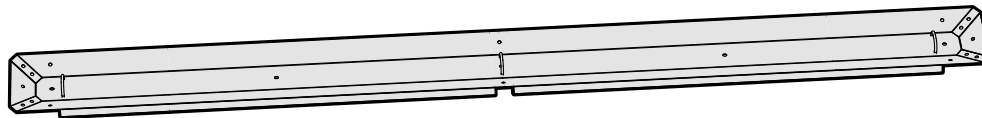

**1#** × 5

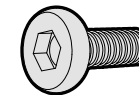

**K1** × 1

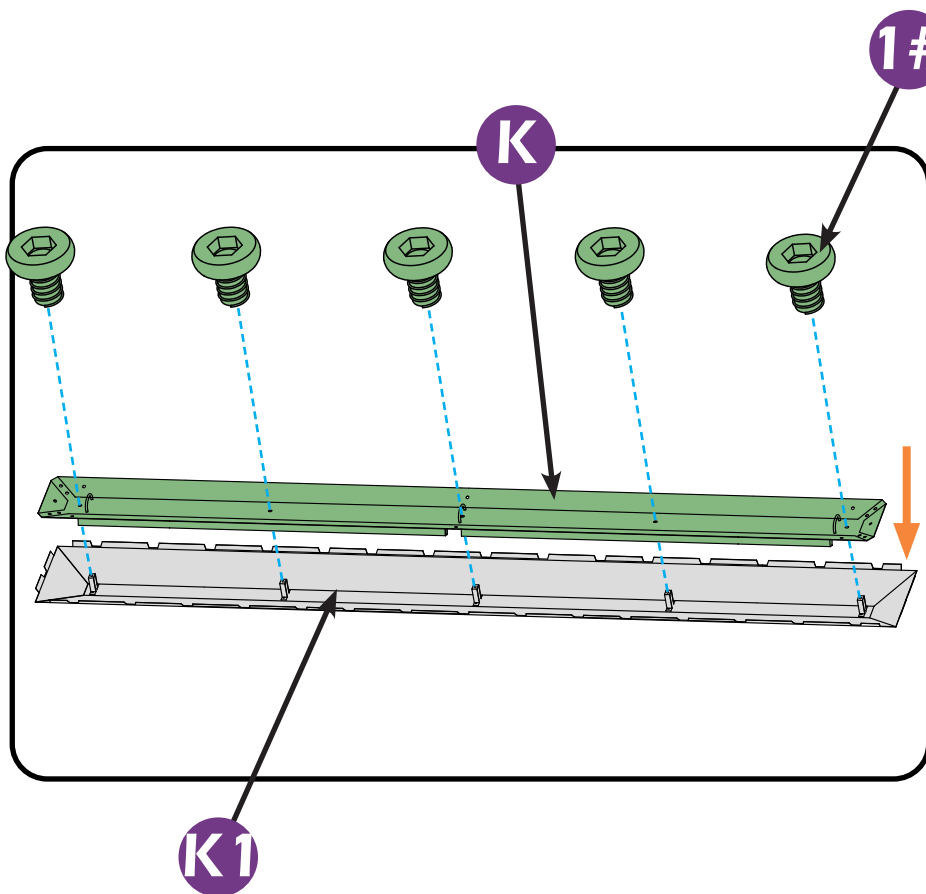
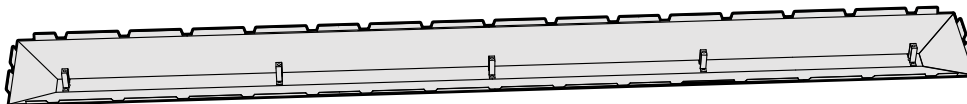

Don't fully tighten the screw **1#**, It might cause problem on roofs installation.

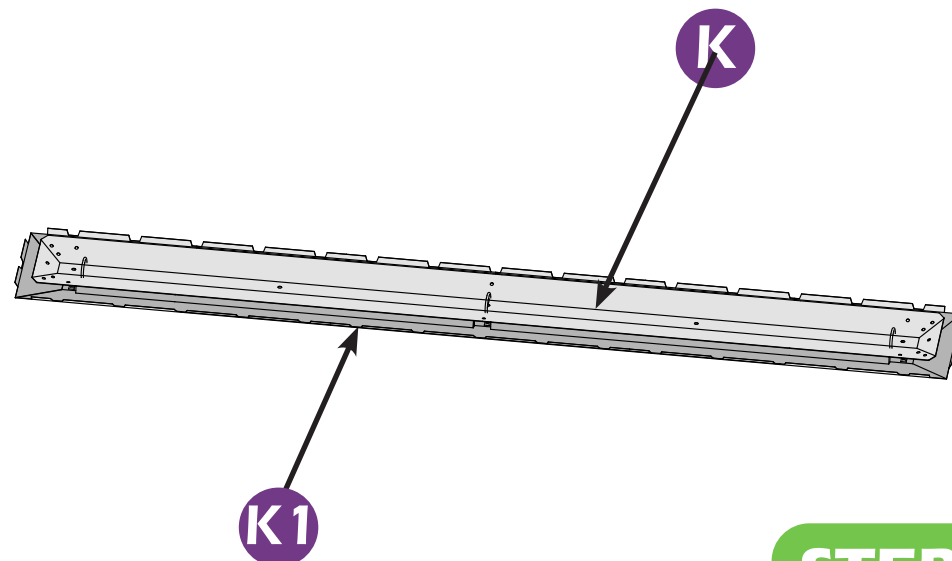

**STEP 2**

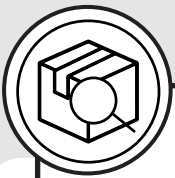

**M** × 1



**N** × 1



**1#** × 3

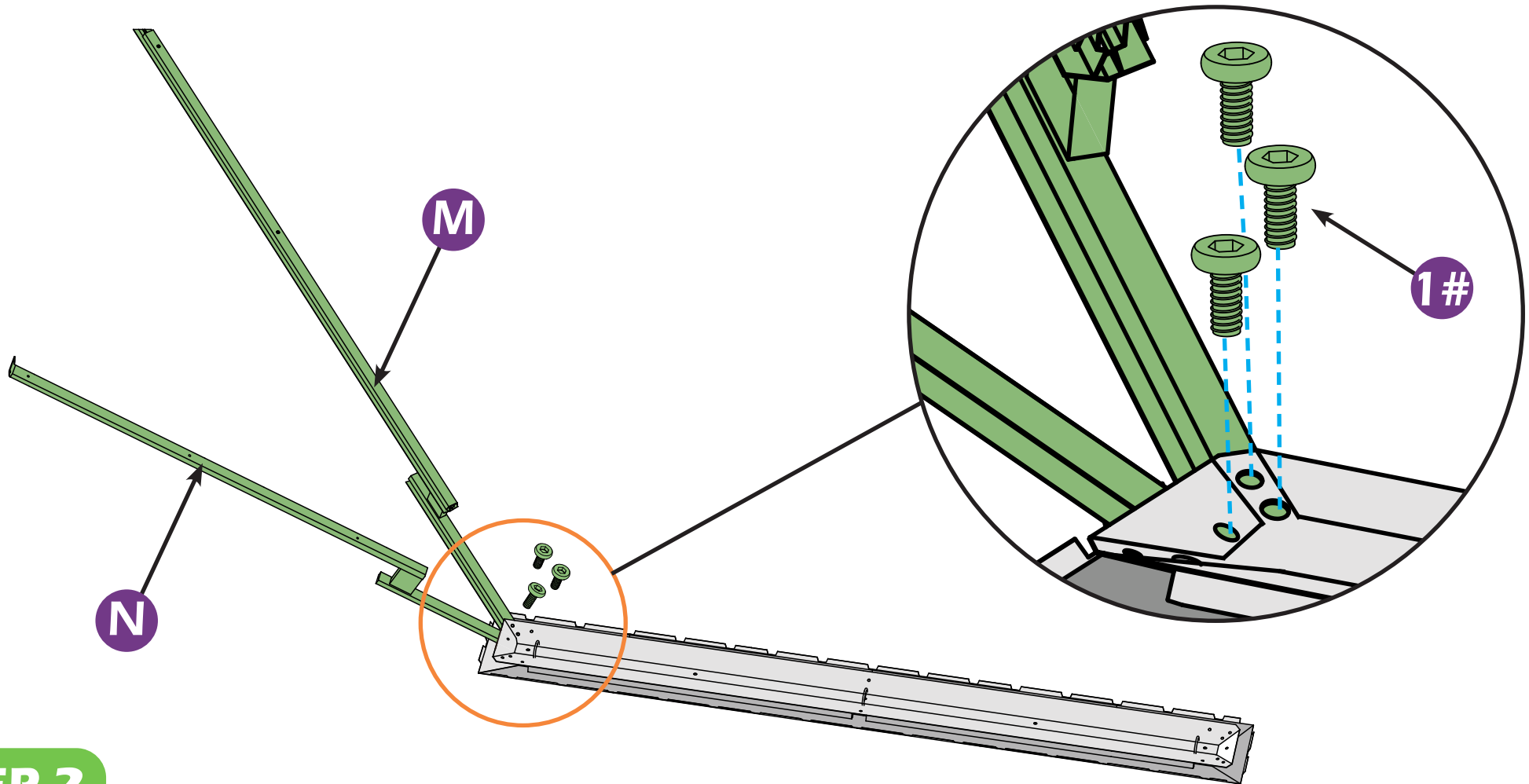
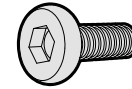

**STEP 2**

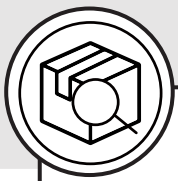

1# x 3

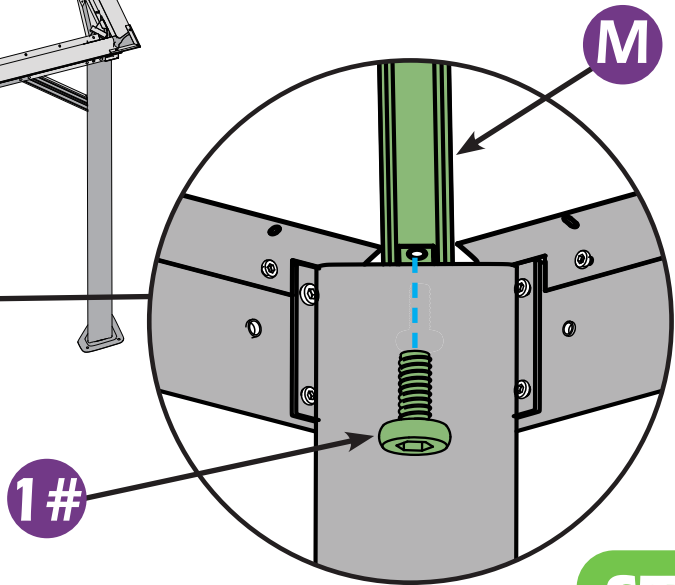
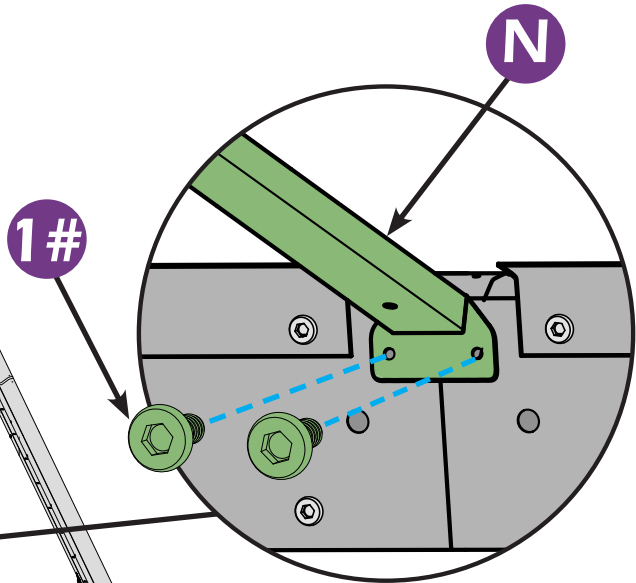
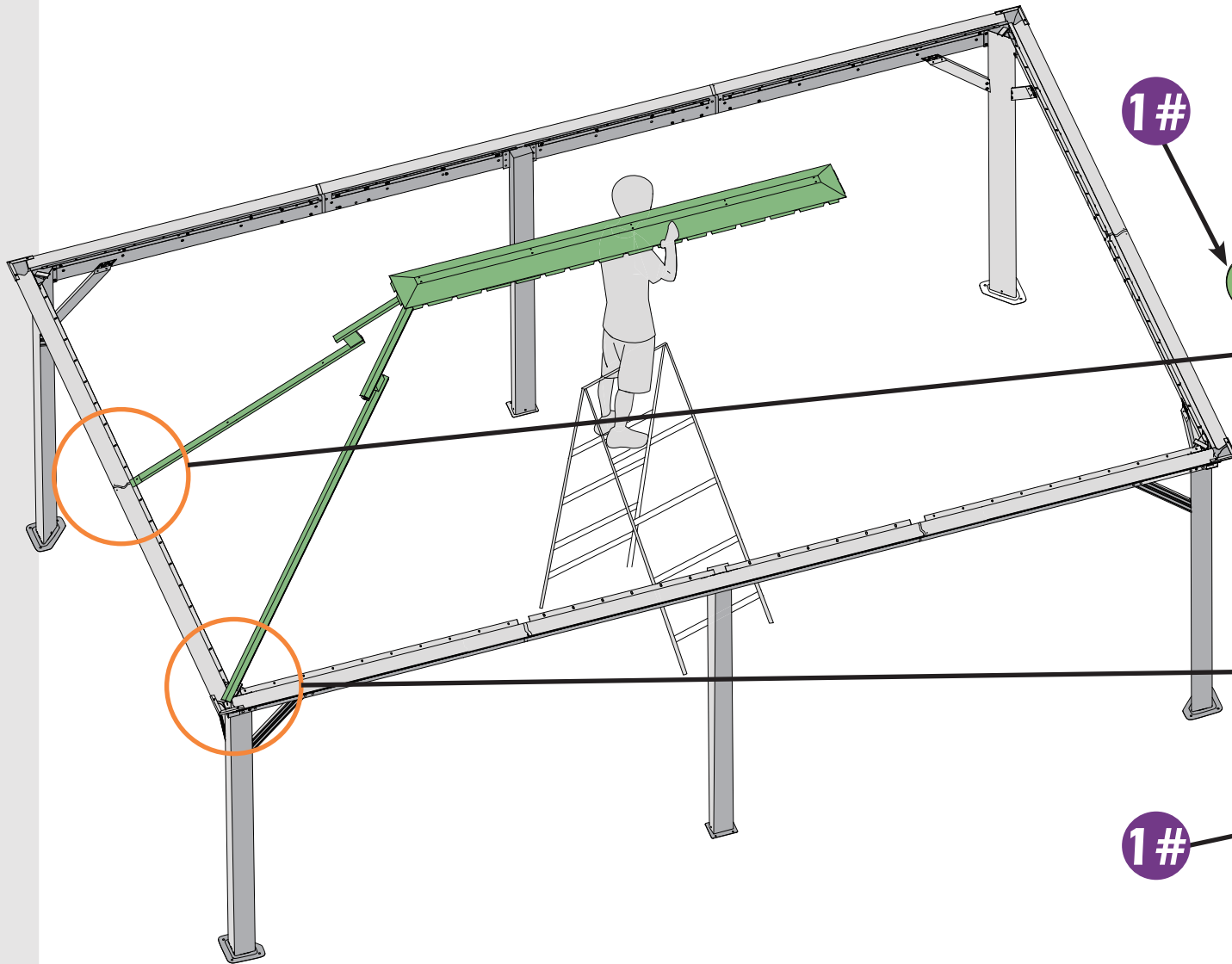
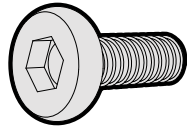

**STEP 2**

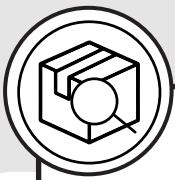

M × 3



1# × 9

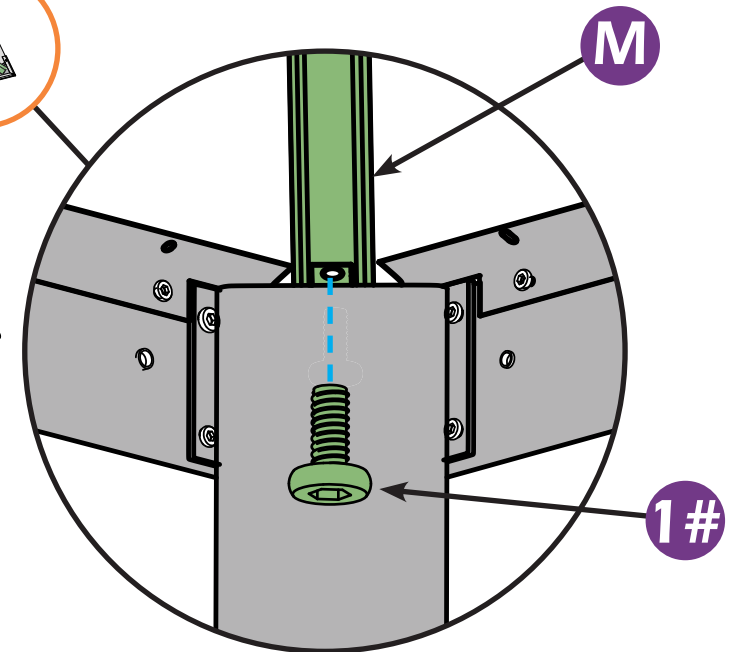
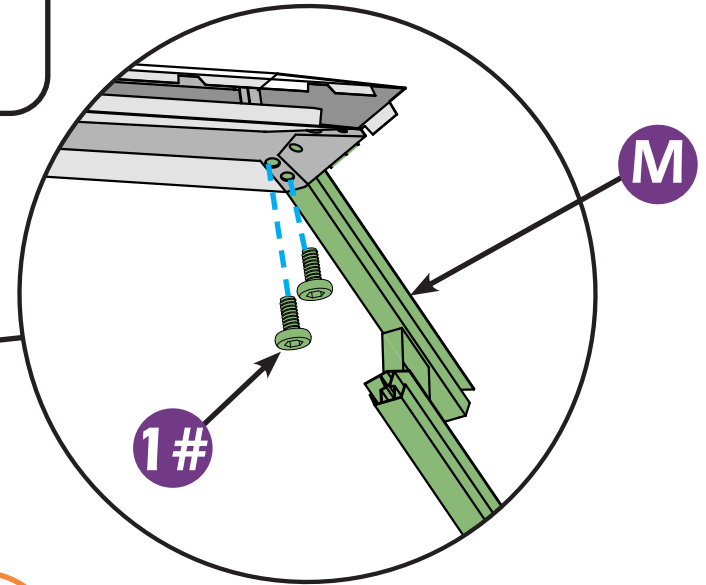
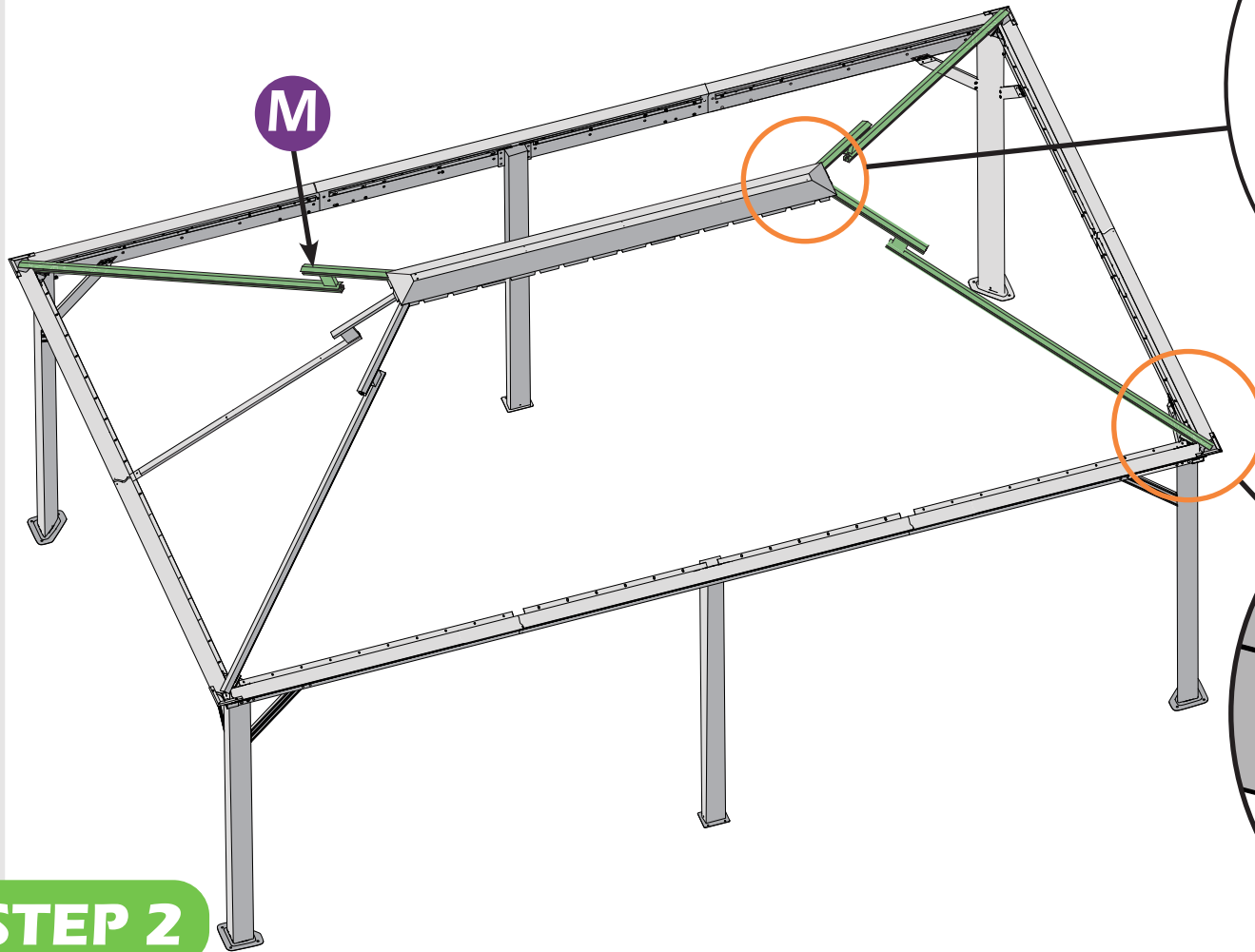
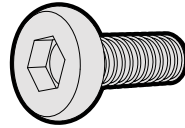

**STEP 2**

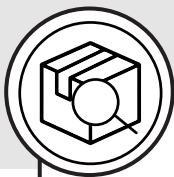

**N** × 1



**1#** × 3

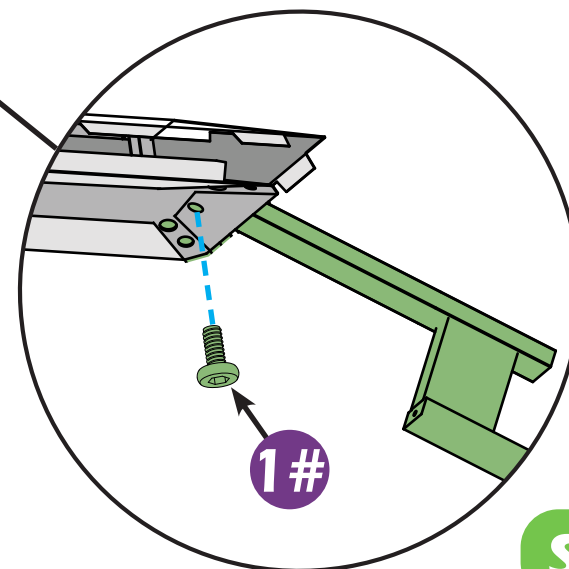
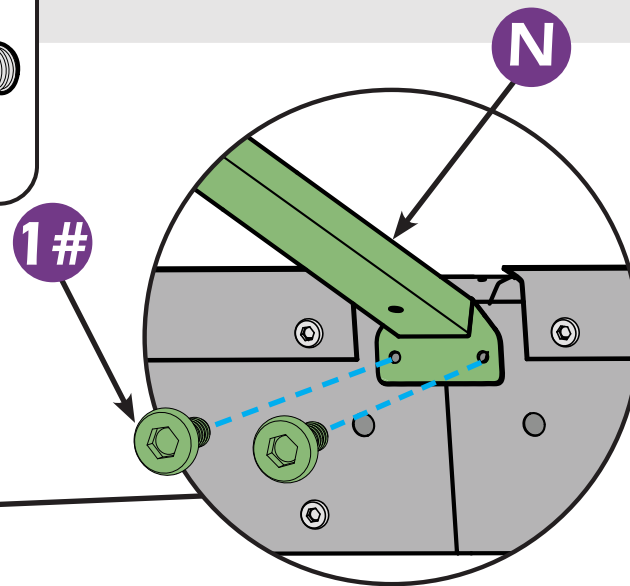
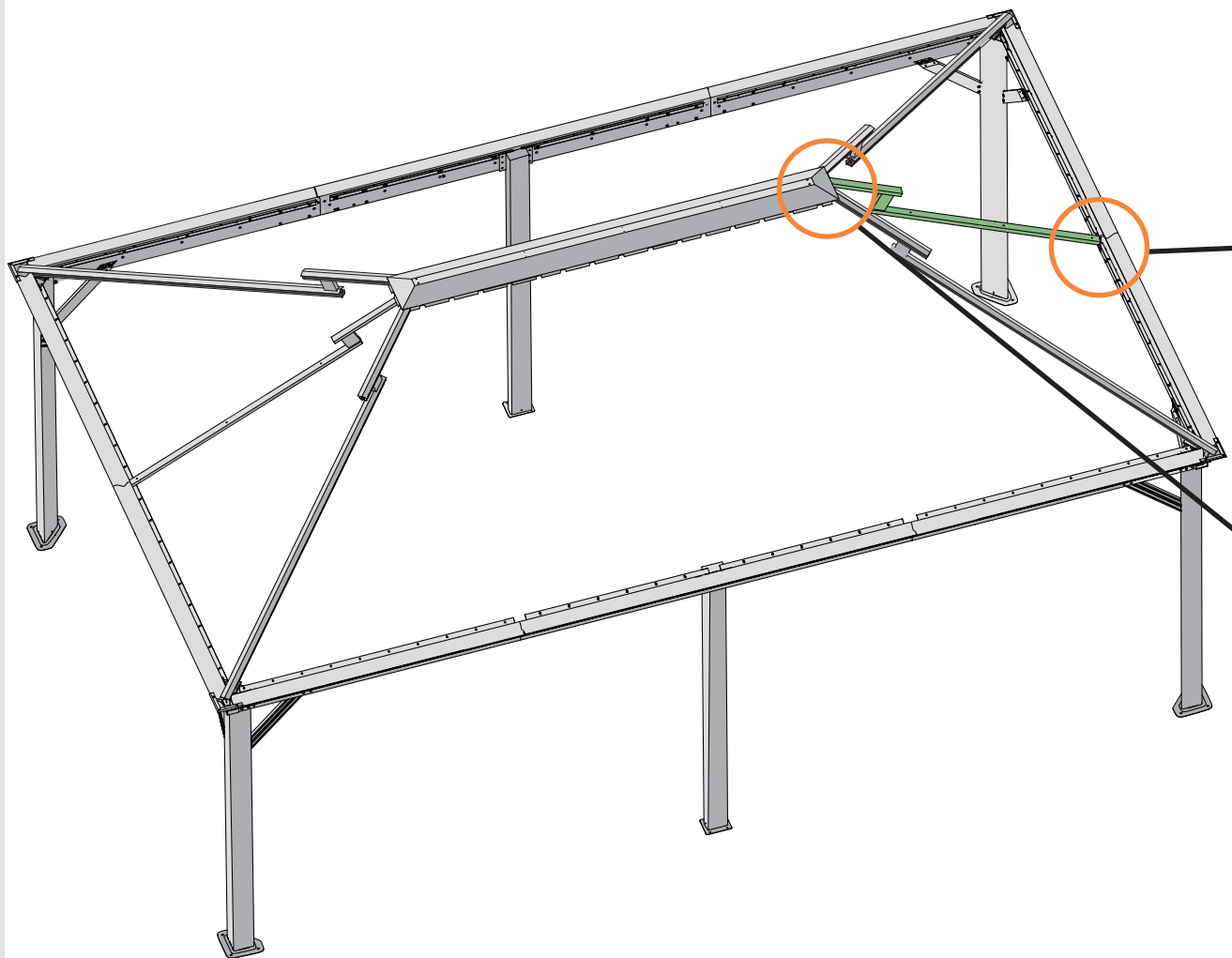
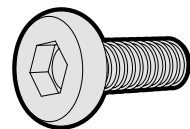

**STEP 2**

Check the the frame as pictures below shows.

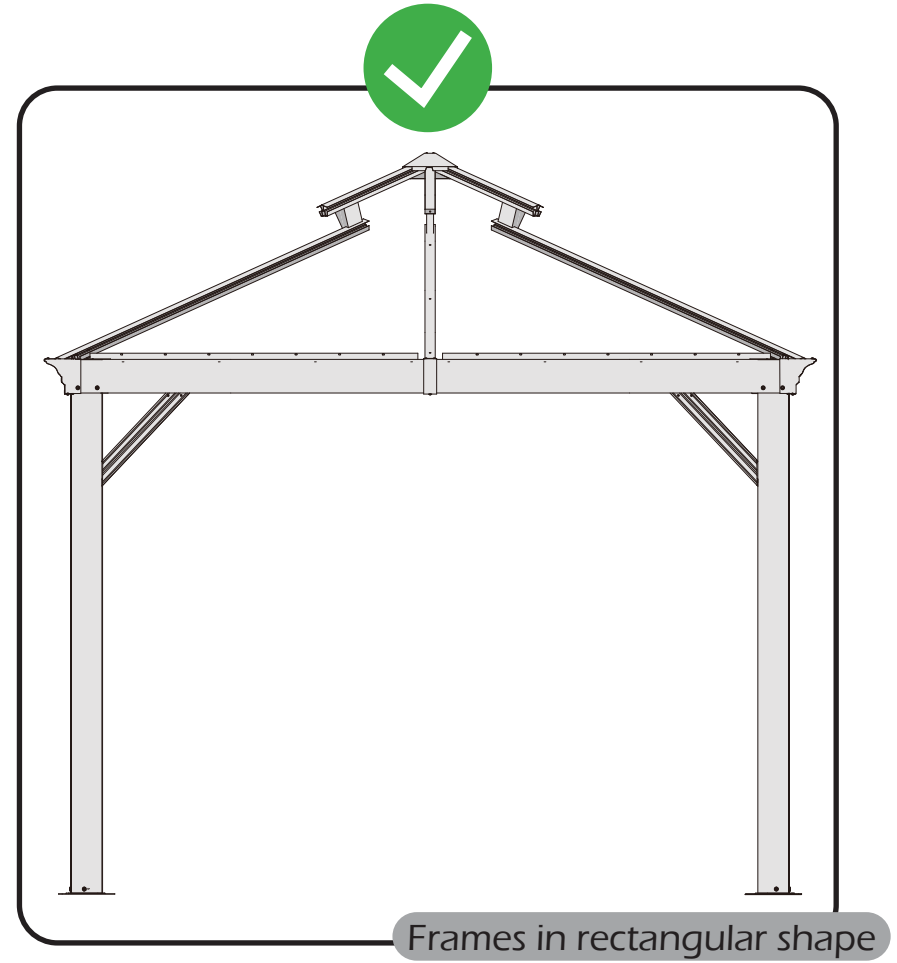
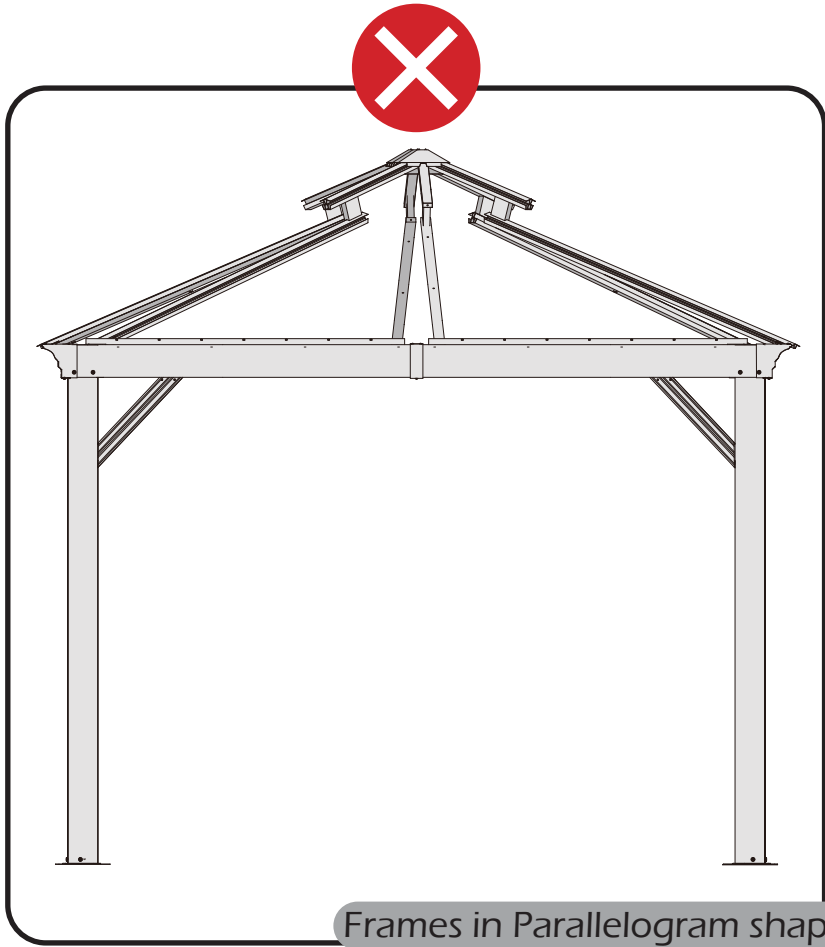

**STEP 2**



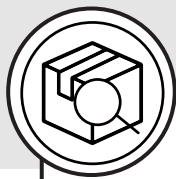

N1 × 4



1# × 18

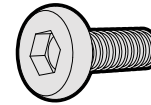

N2 × 2

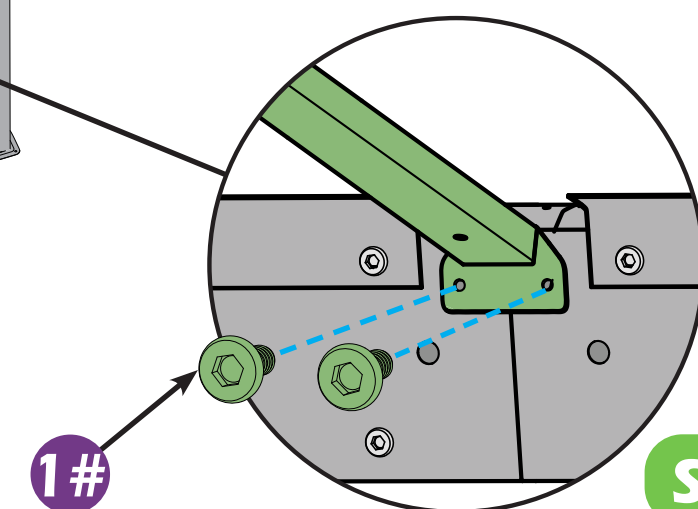
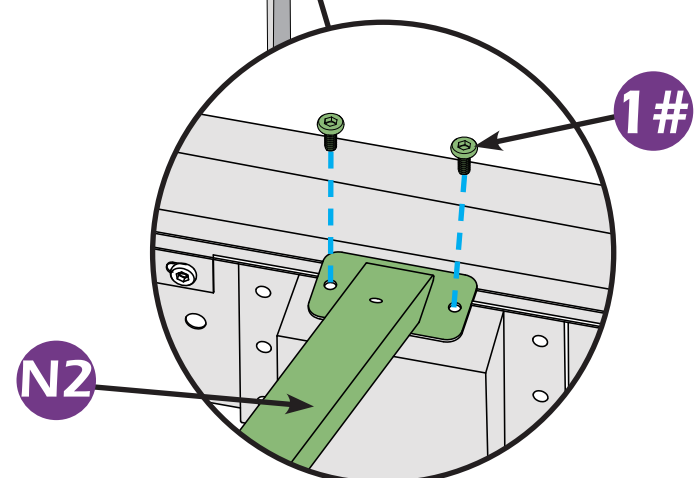
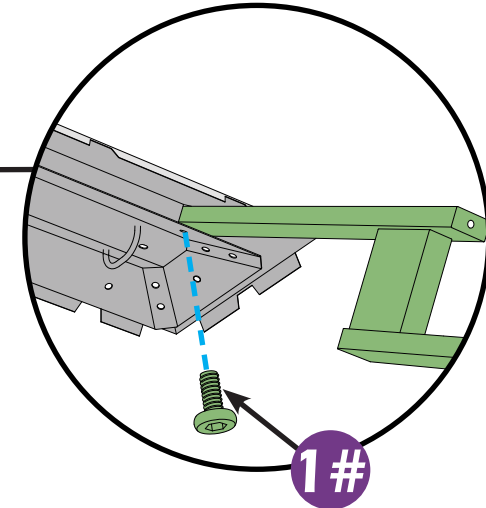
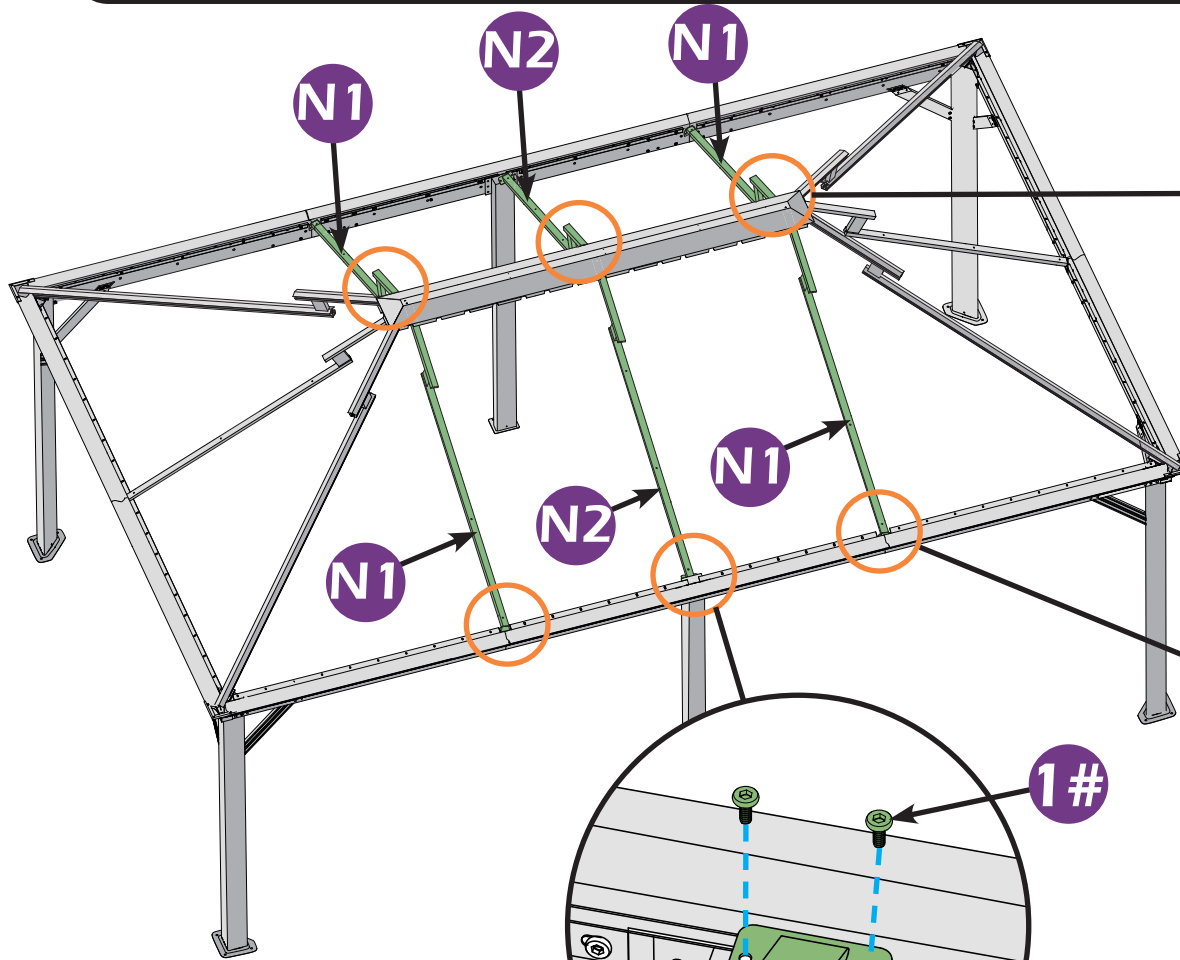
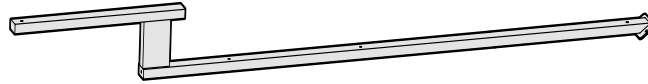

**STEP 2**

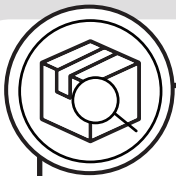

**P** × 2

**R** × 4

**1#** × 4

**Q1** × 2

**Q2** × 2

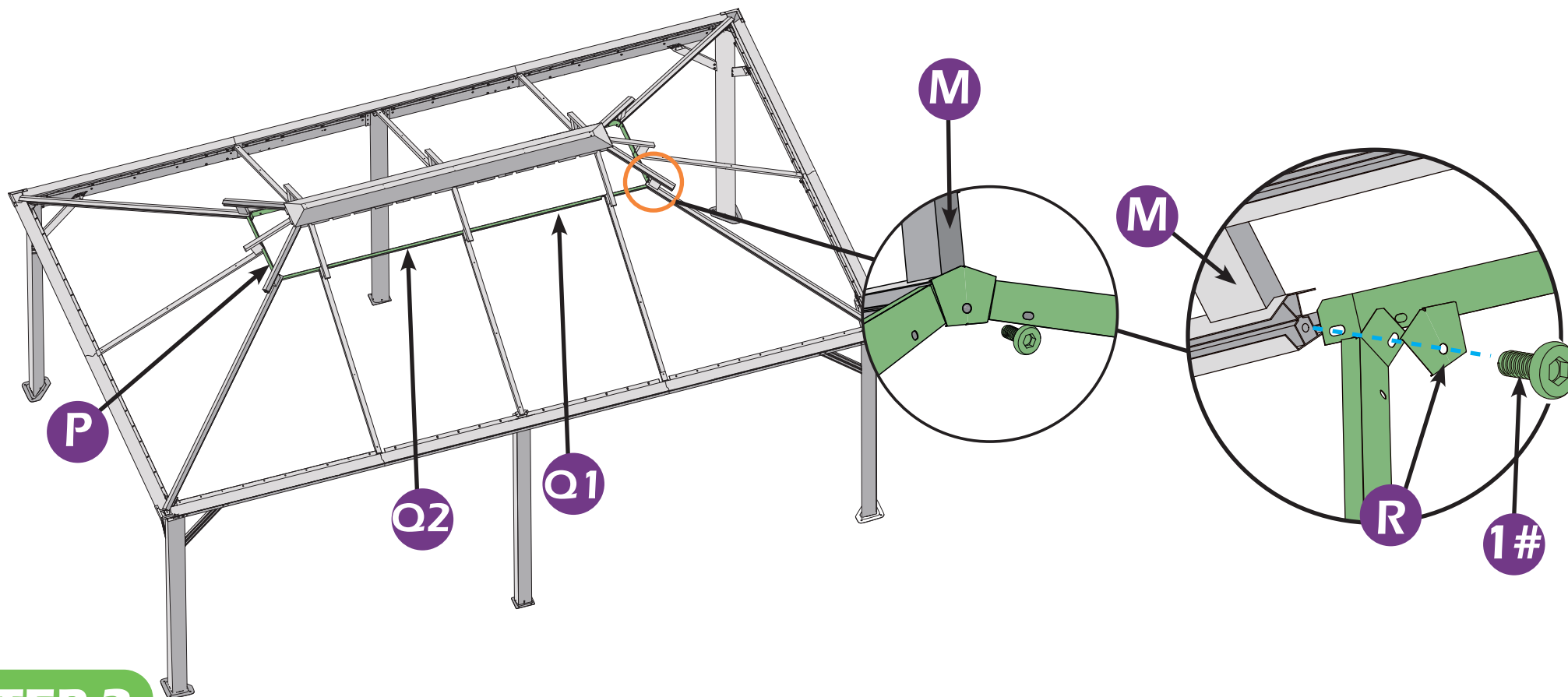

**STEP 2**

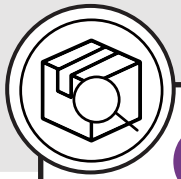

**P1**×2

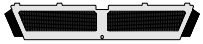

**Q3**×2

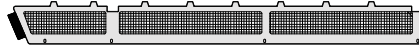

**Q4**×2

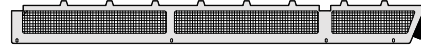

**1#**×8

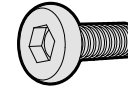

**11#**×12

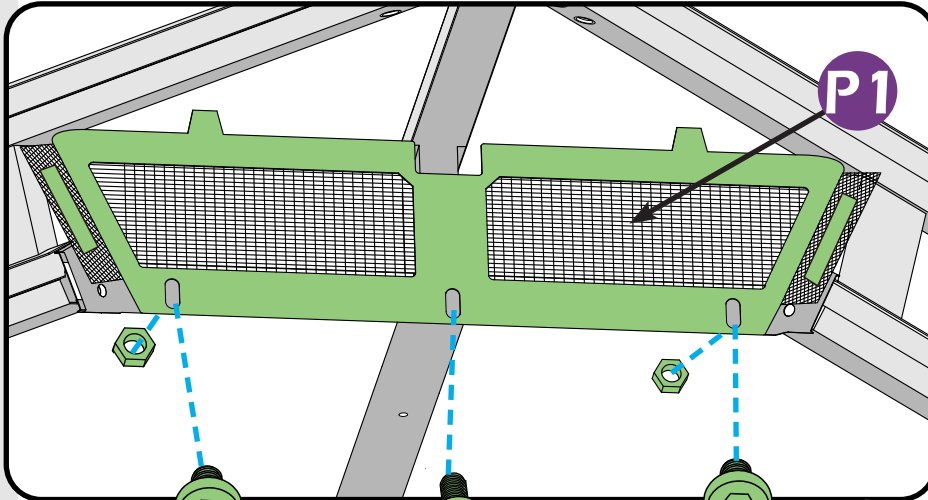
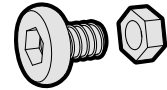

**11#**

**1#**

**11#**

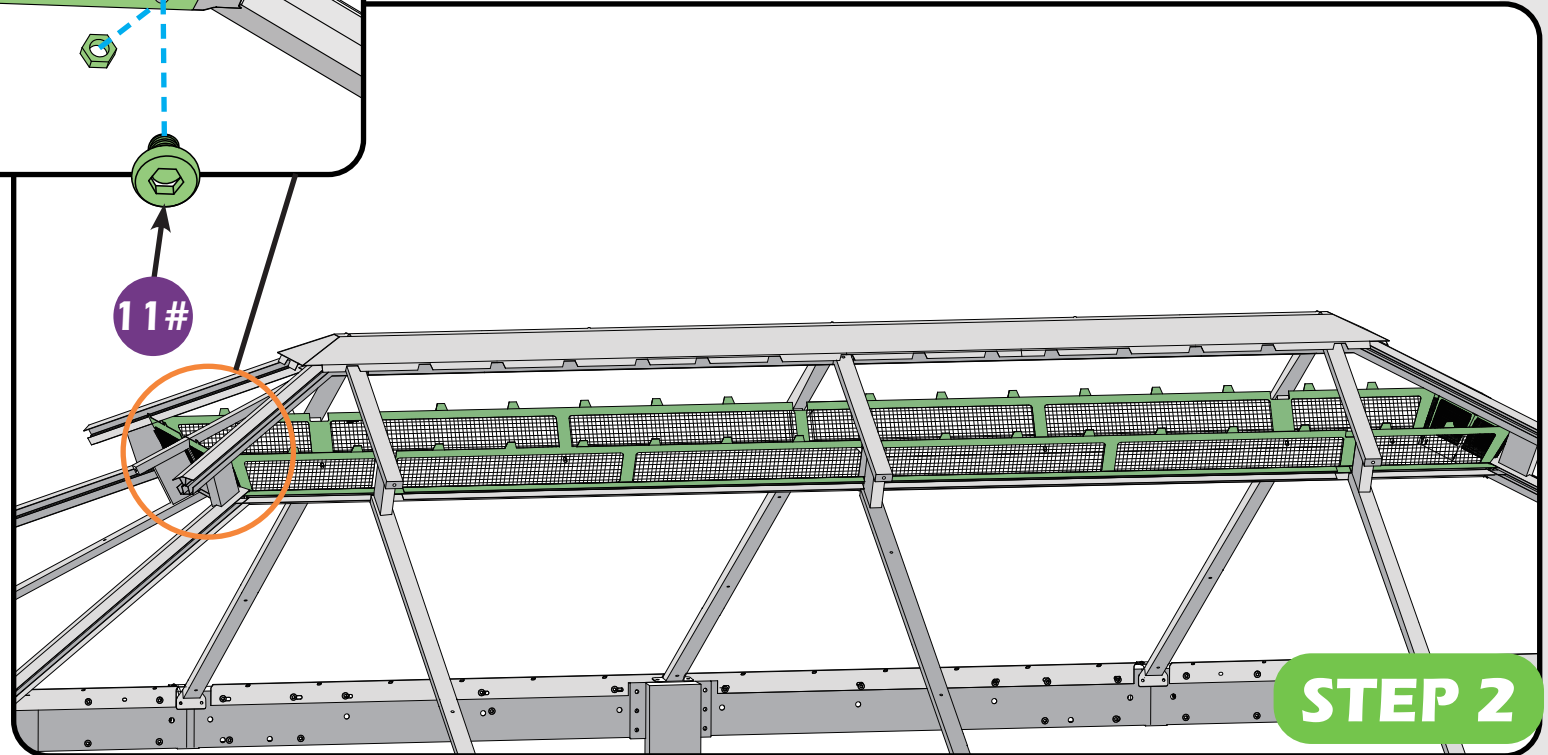

**STEP 2**

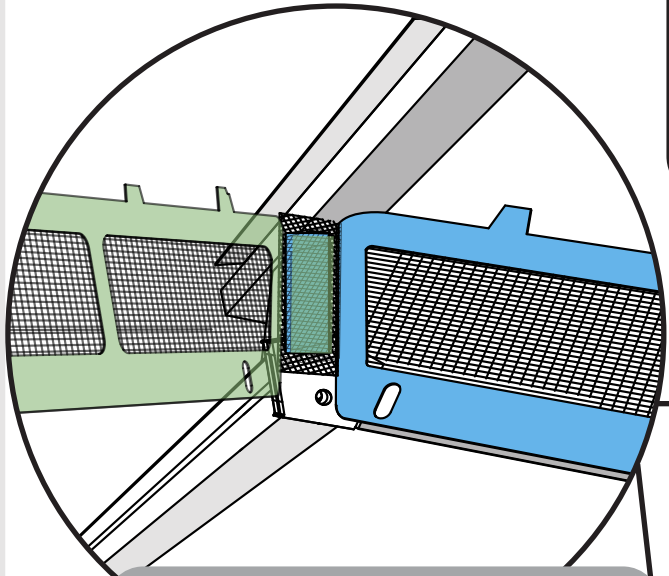

Don't forget to stick the velcro between the bug netting

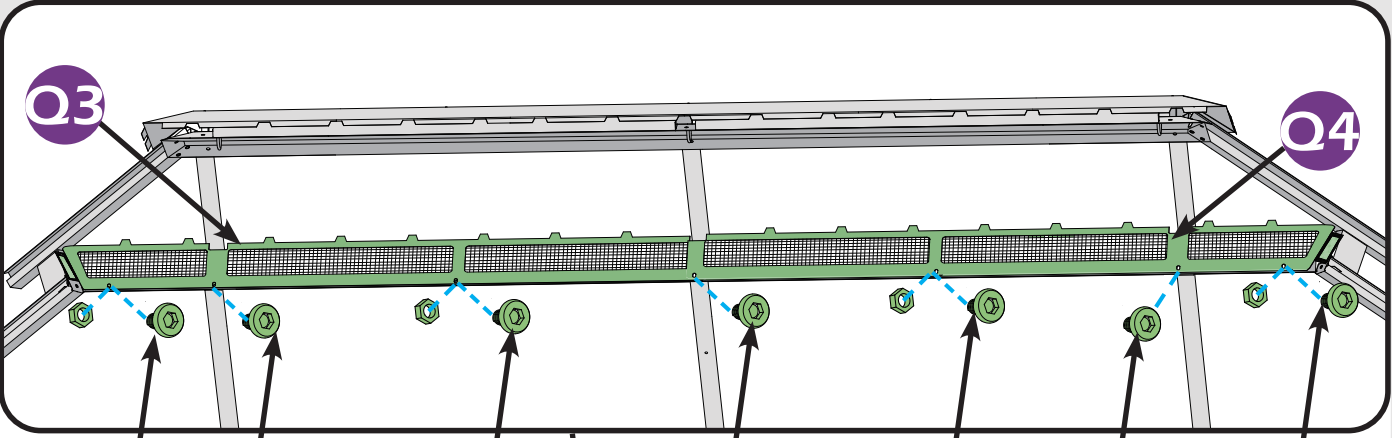

11# 1# 11# 1# 11# 1# 11#

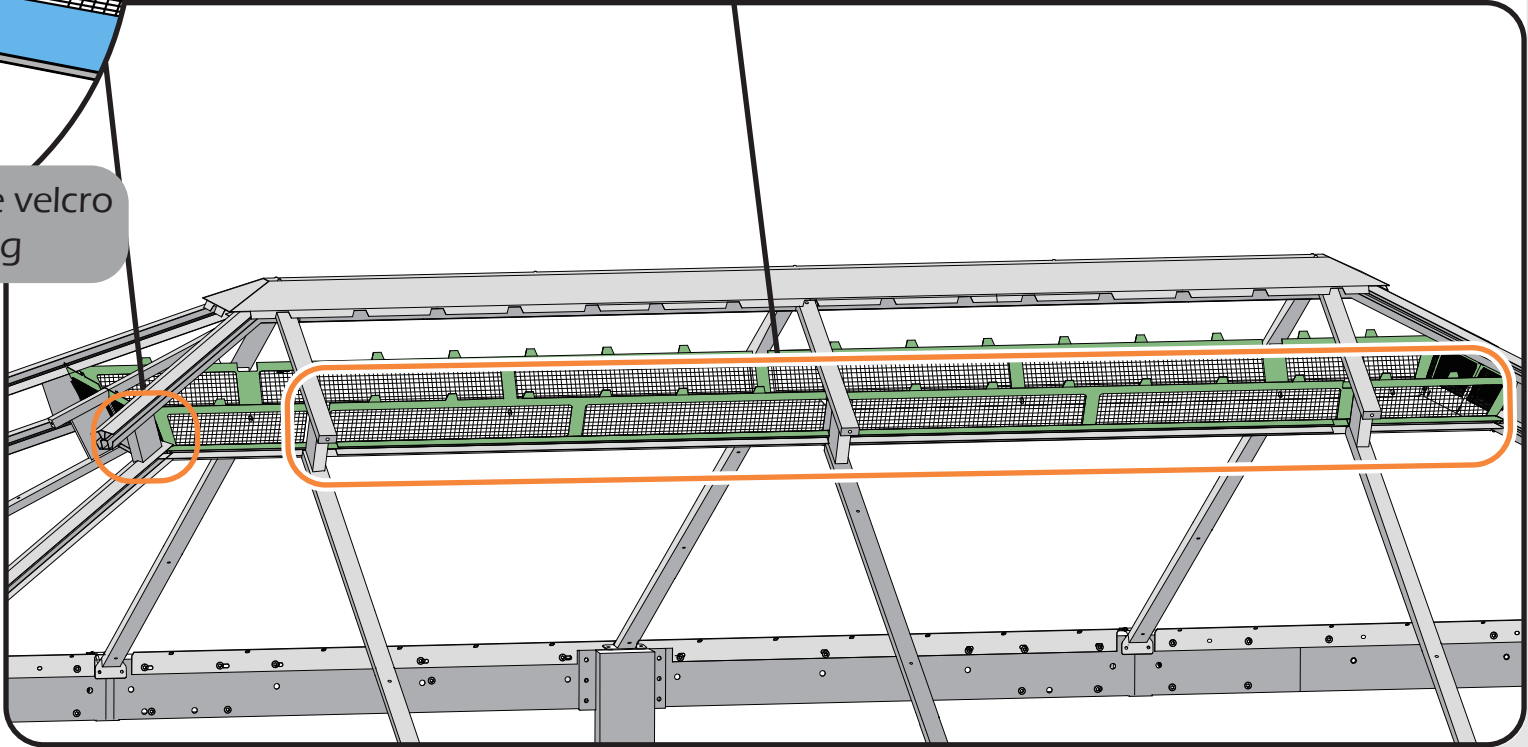

**STEP 2**

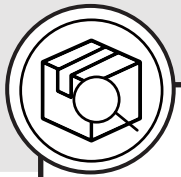

T × 2



R × 4

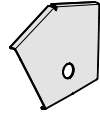

R1 × 2

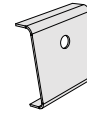

1# × 12

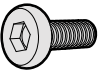

T1 × 2



T2 × 2

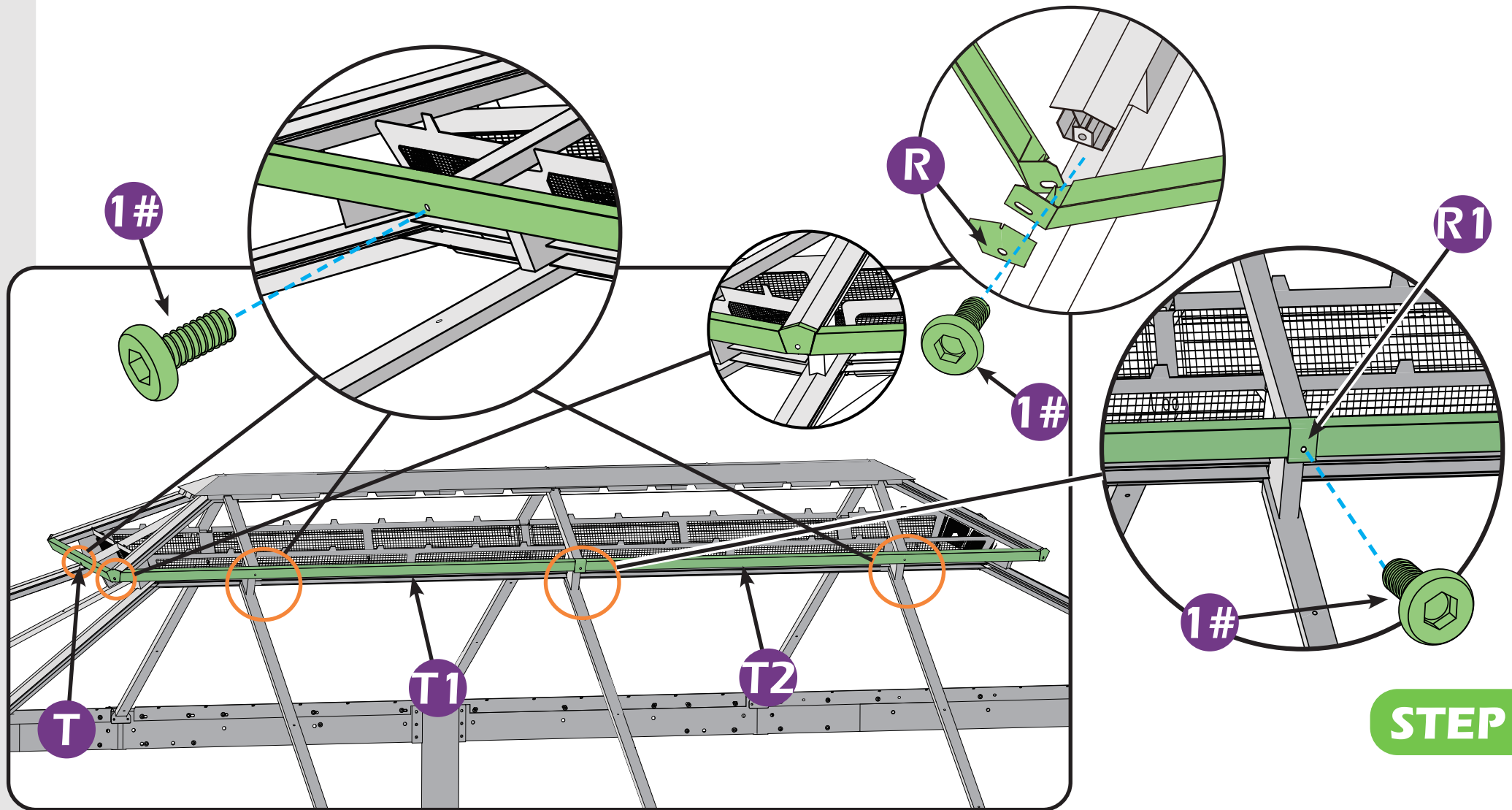
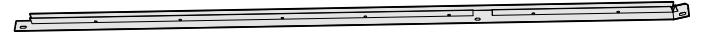

**STEP 2**

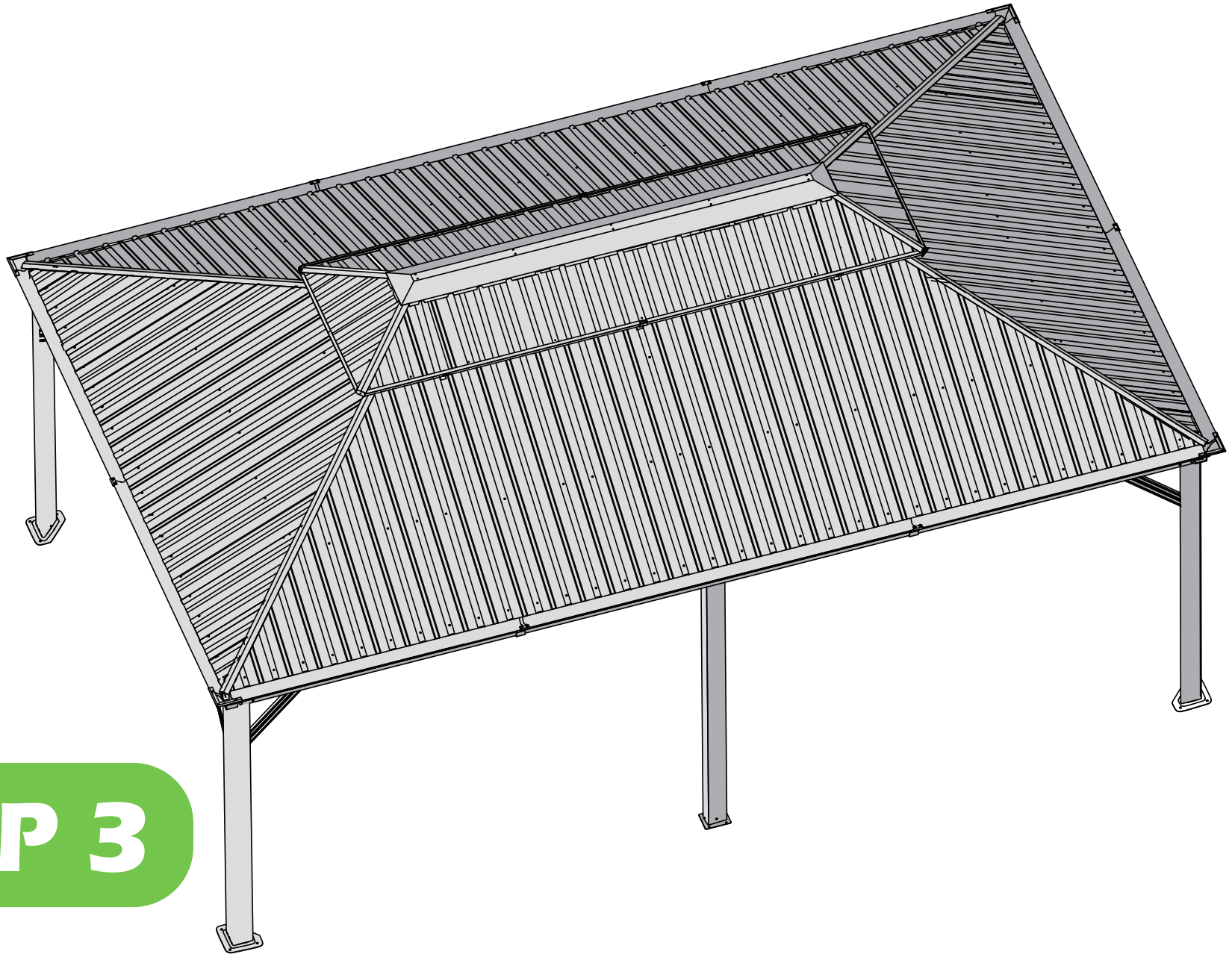

**STEP 3**

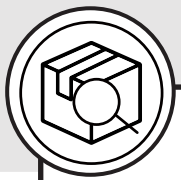

V1 x 2

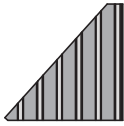

V2 x 2

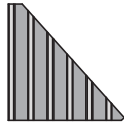

Z1 x 4



Z x 4



Z2 x 4

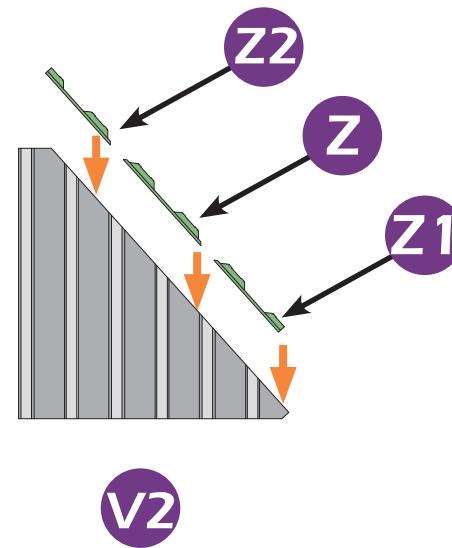
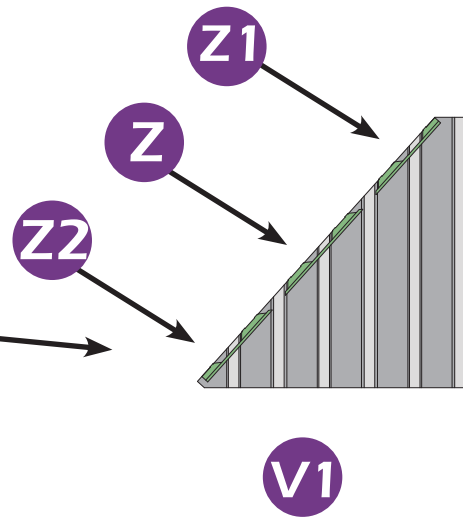
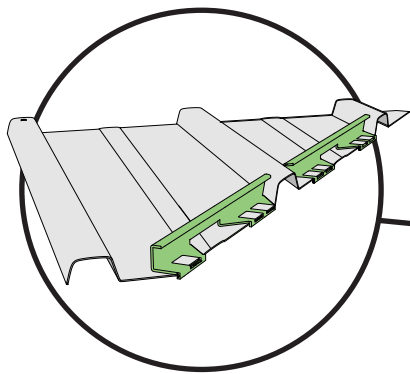

**STEP 3**

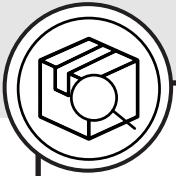

V × 8

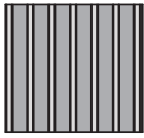

V3 × 2



V4 × 2

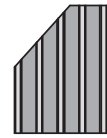

V5 × 2

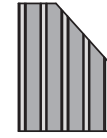

V6 × 2



Z × 8



Z3 × 2



Z4 × 2

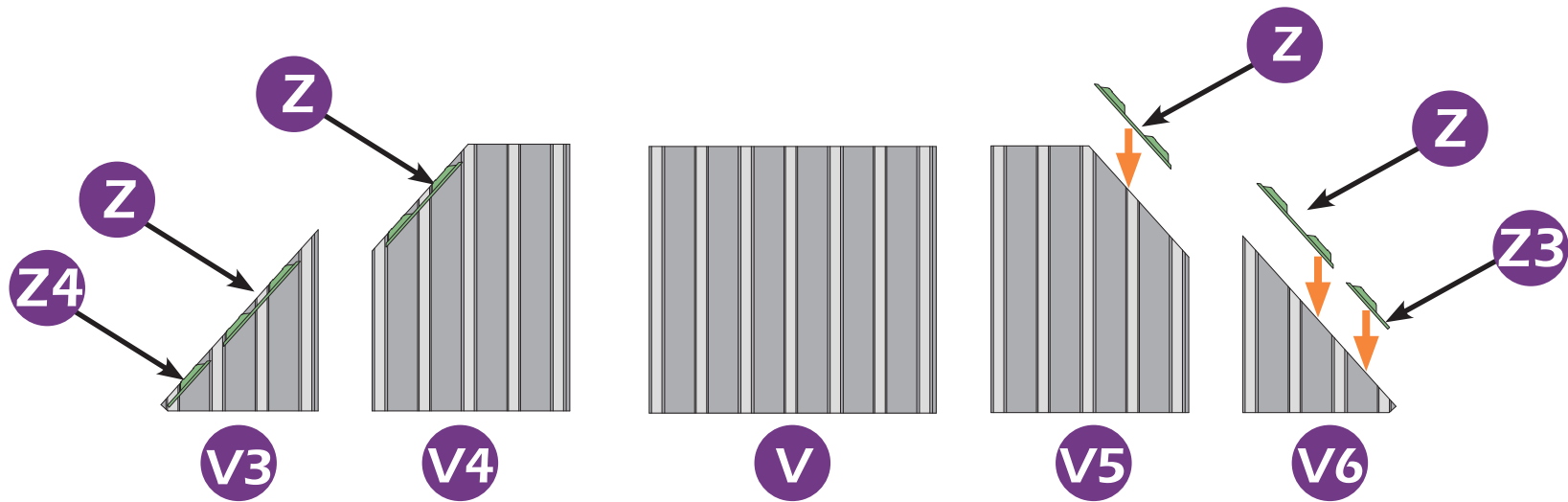

**STEP 3**



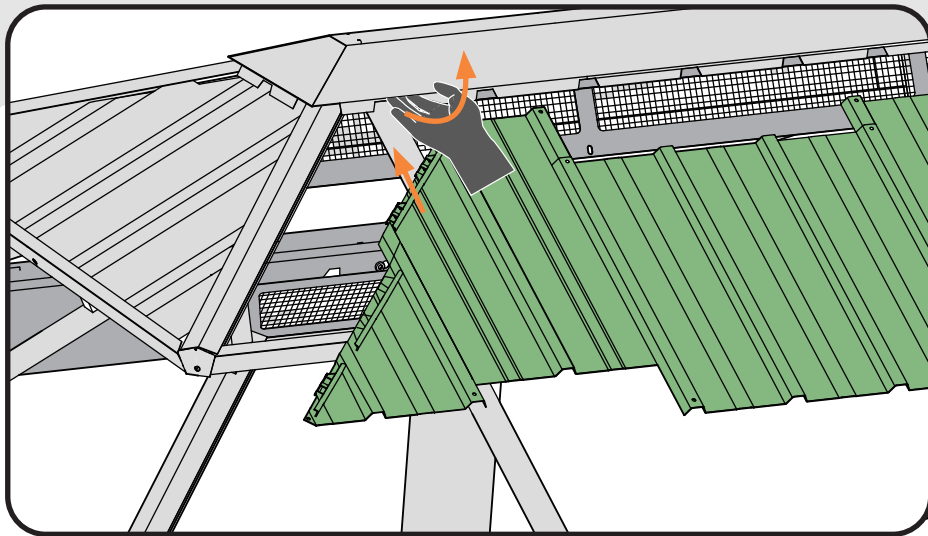

If you can't install **V4** or **V5**, push the part K up and try to insert them again.

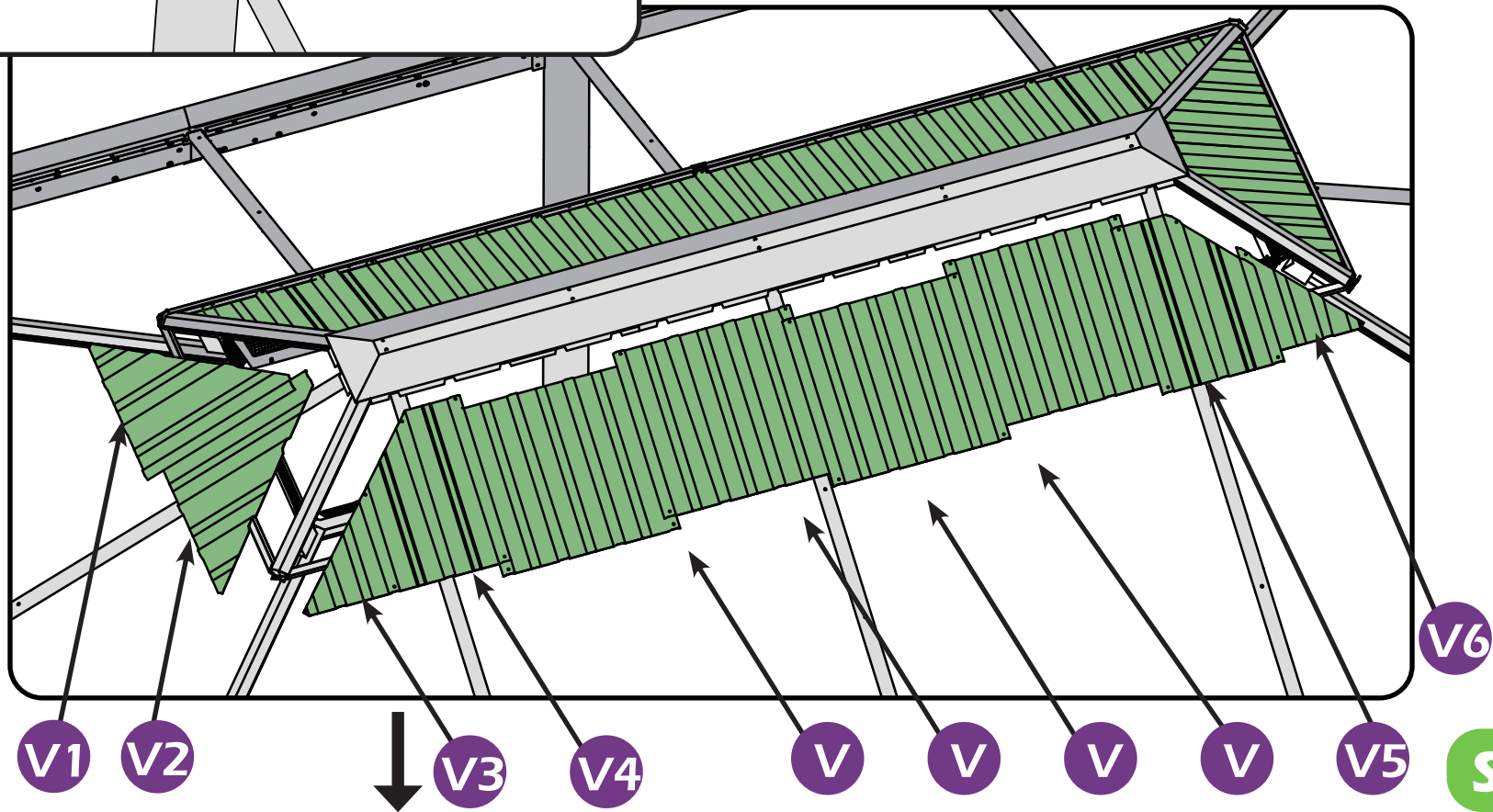

**STEP 3**

1#

Fully fasten the 1# bolts in K & K1.

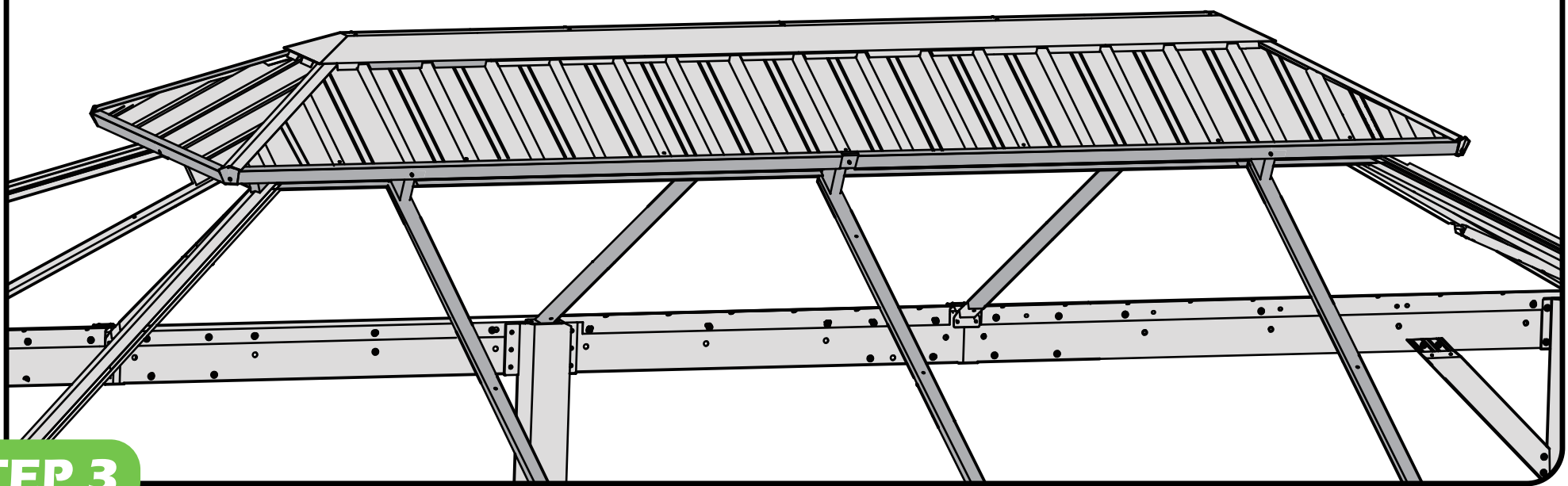
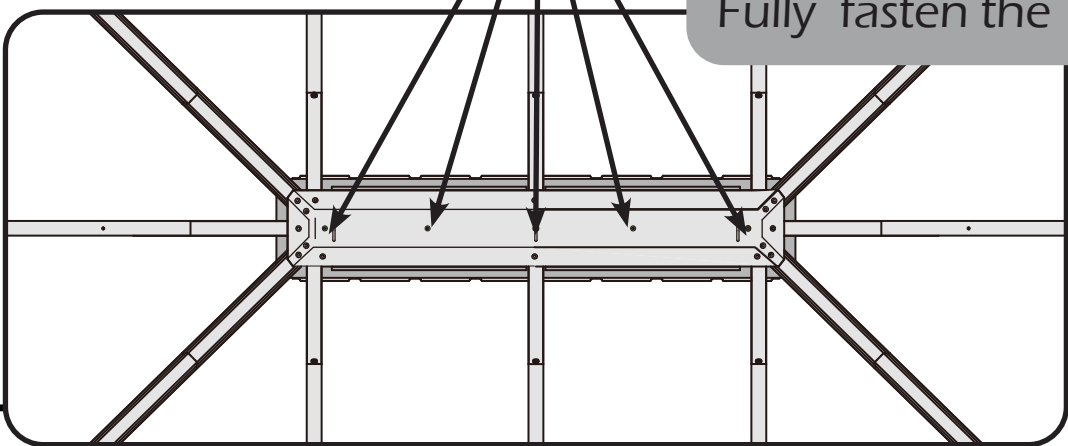

STEP 3

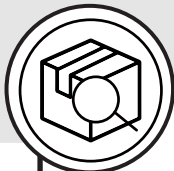

U1 × 4



U3 × 4

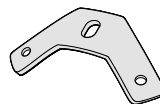

U4 × 8

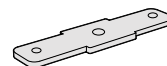

1# × 36

U2 × 4



U5 × 4

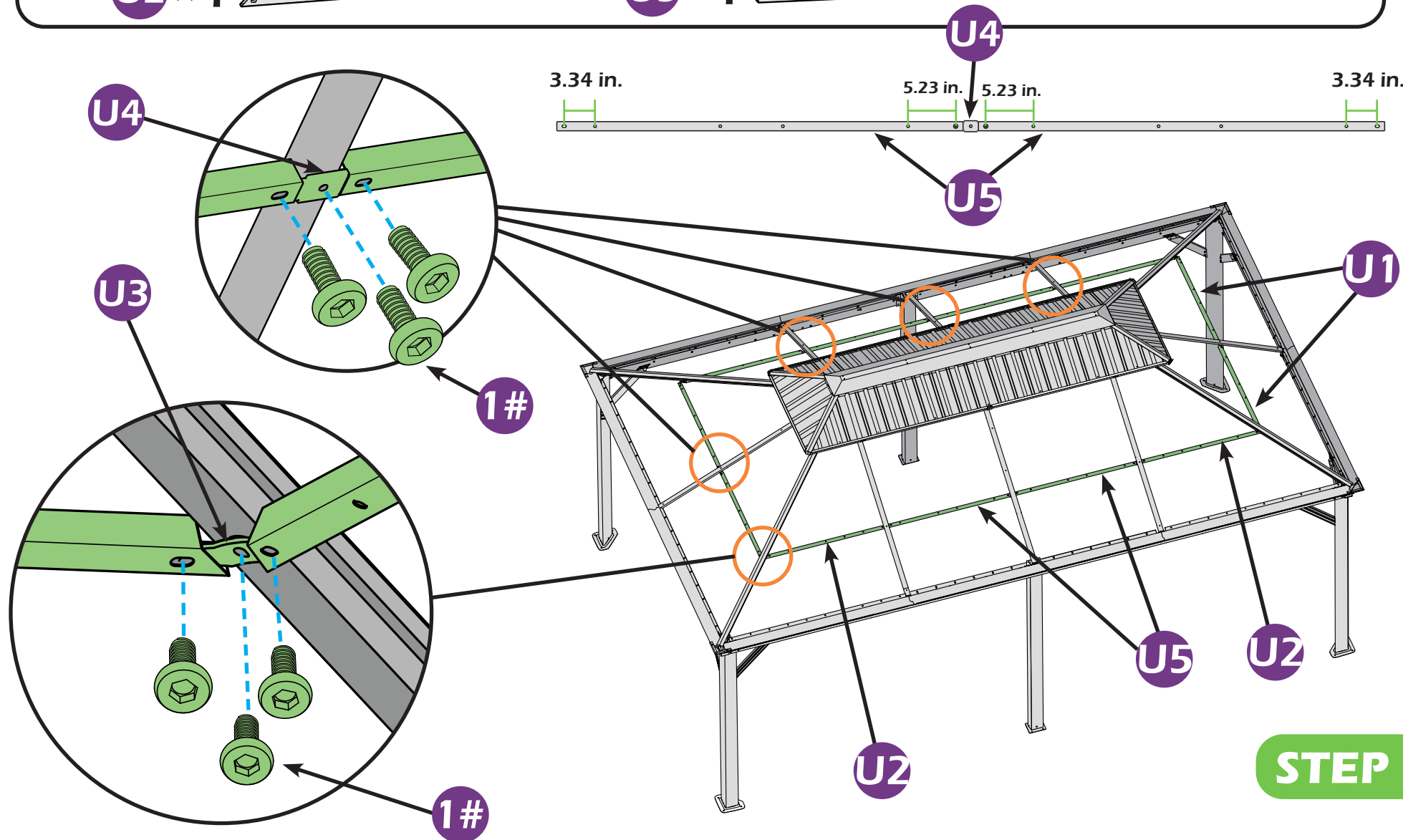
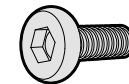

**STEP 3**

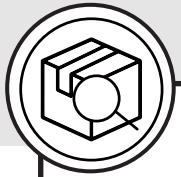

W1 × 2

W2 × 2

W3 × 2

W4 × 2

Z × 32

W8 × 2

W7 × 2

W6 × 2

W5 × 2

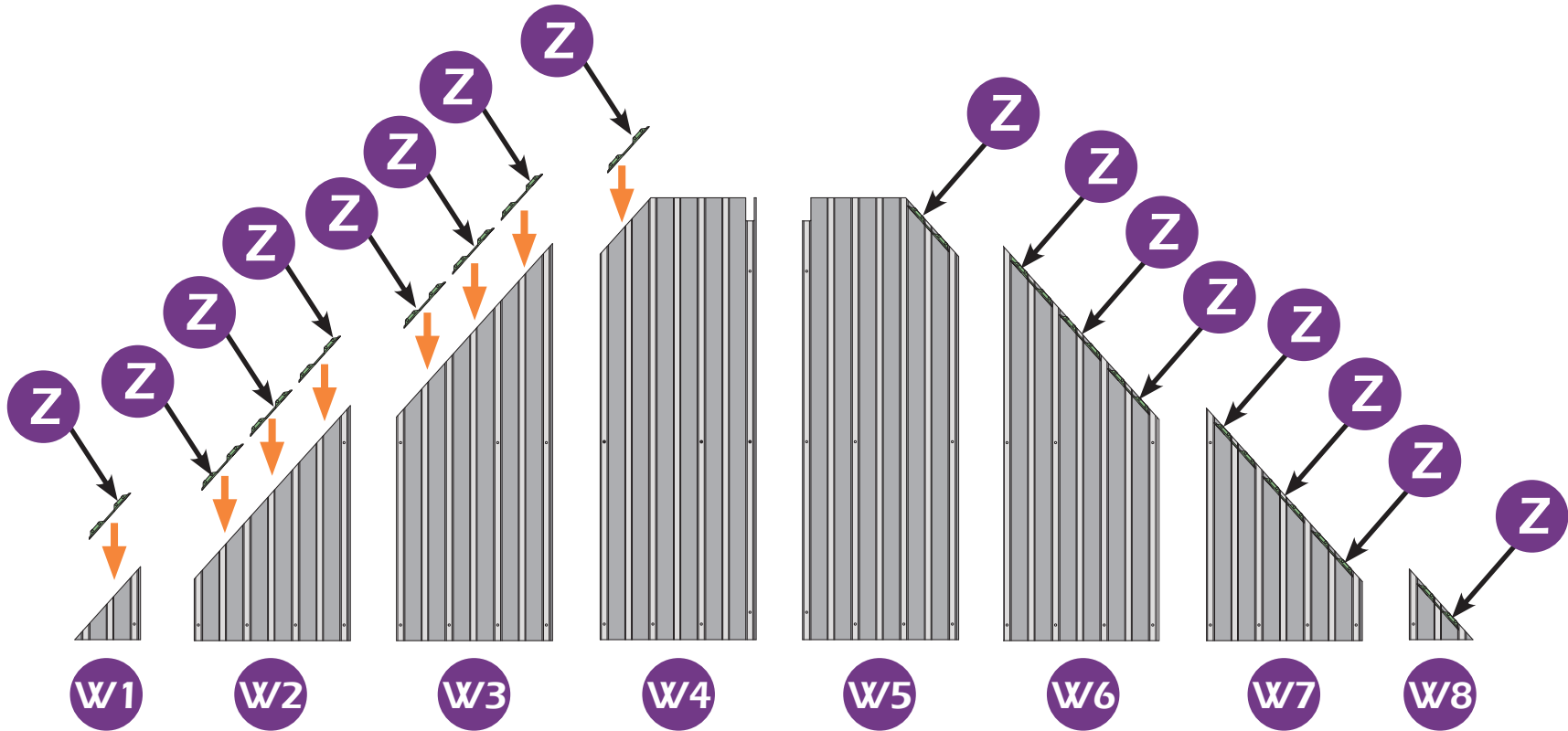

### STEP 3

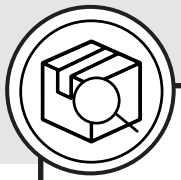

**X5** × 2

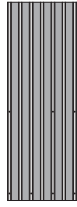

**X6** × 2

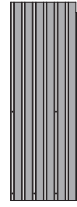

**X7** × 2

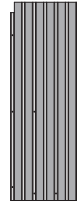

**X8** × 2

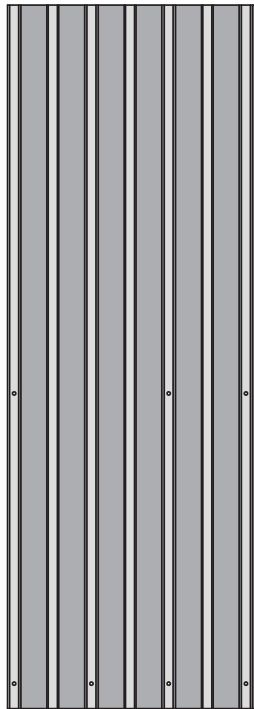
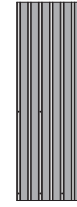

**X5**

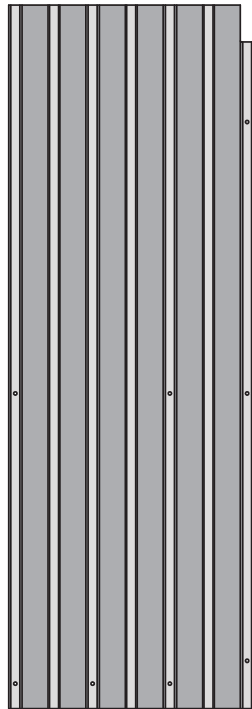

**X6**

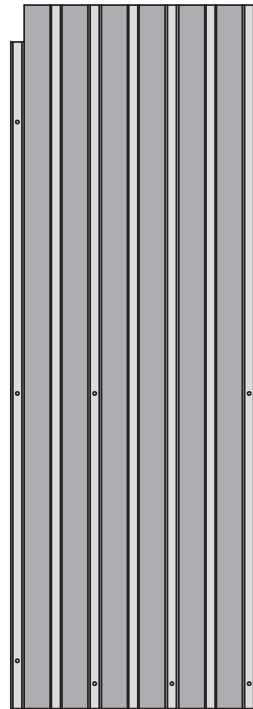

**X7**

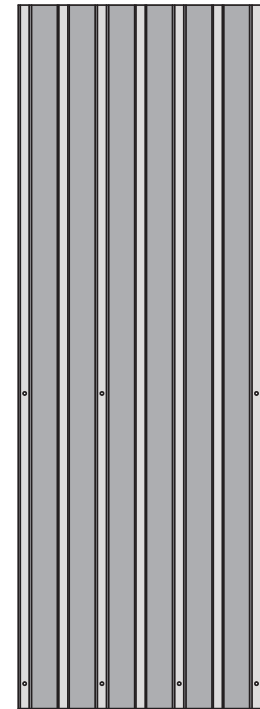

**X8**

**STEP 3**

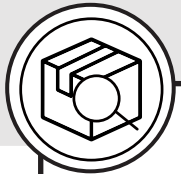

X1 × 2

X2 × 2

X3 × 2

X4 × 2

Z × 28

X9 × 2

X10 × 2

X11 × 2

X12 × 2

Z1 × 2

Z2 × 2

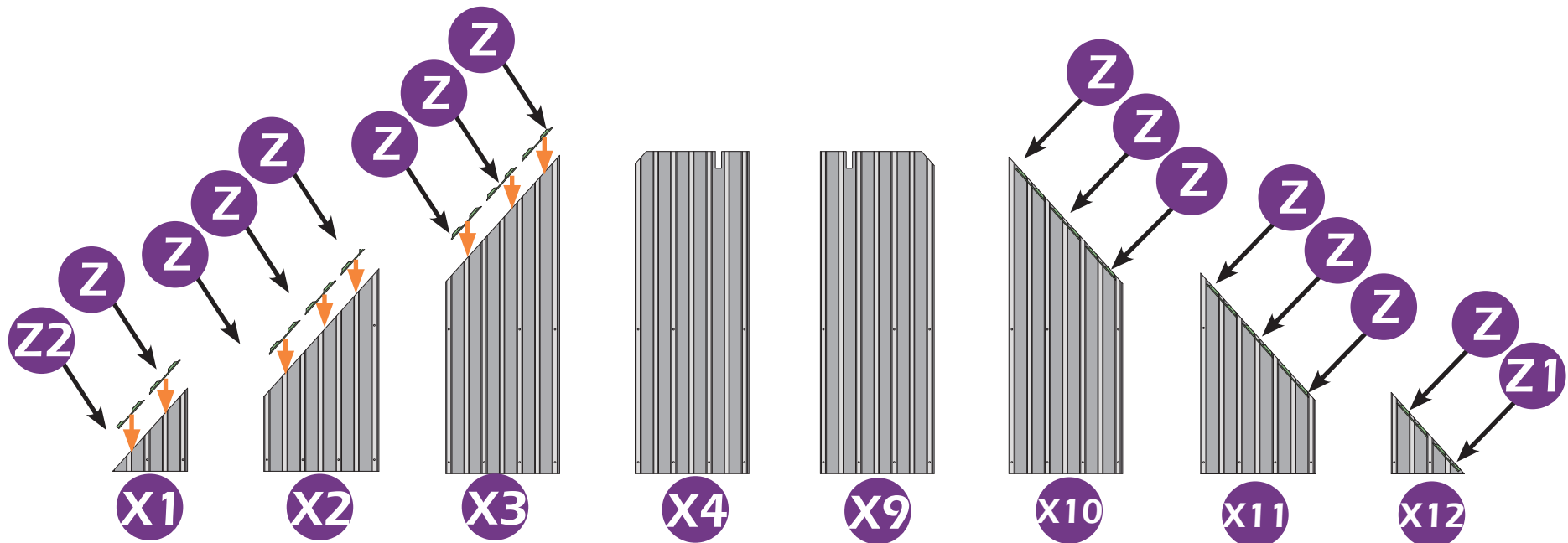

### STEP 3

Install the middle panels ( X6 , X7 or W4 , W5 ) then the small panels on the edge.

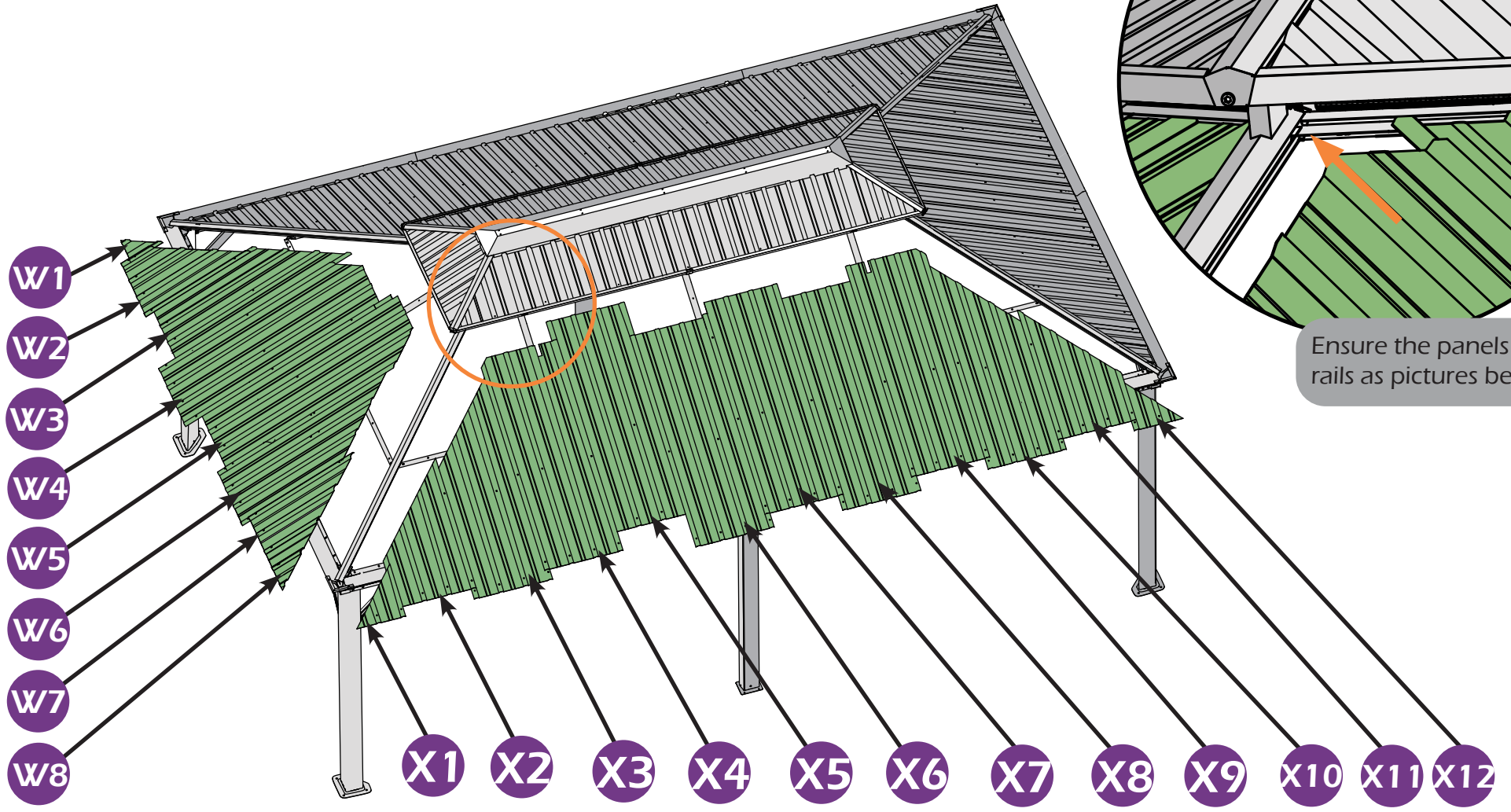

Ensure the panels stay in the rails as pictures below indicate.

**STEP 3**



5#×100

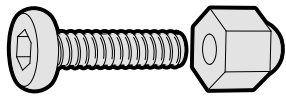

10#×4

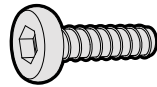

S×104

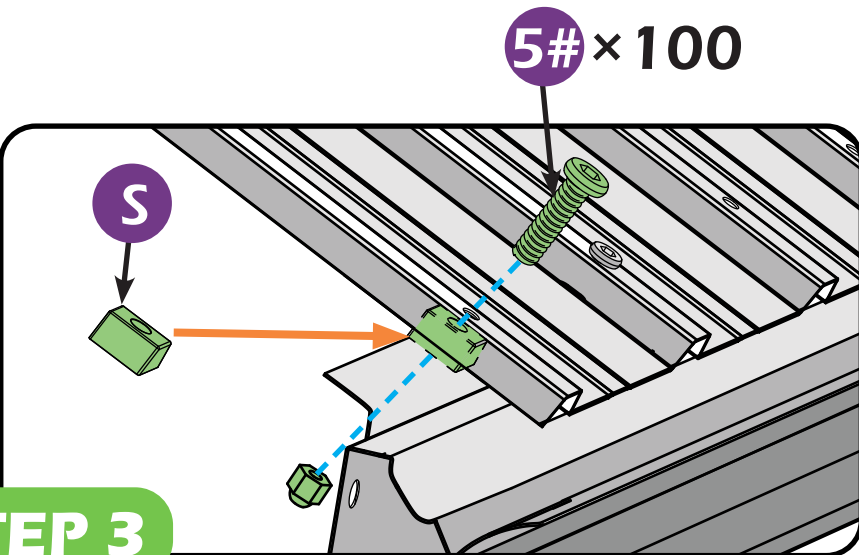
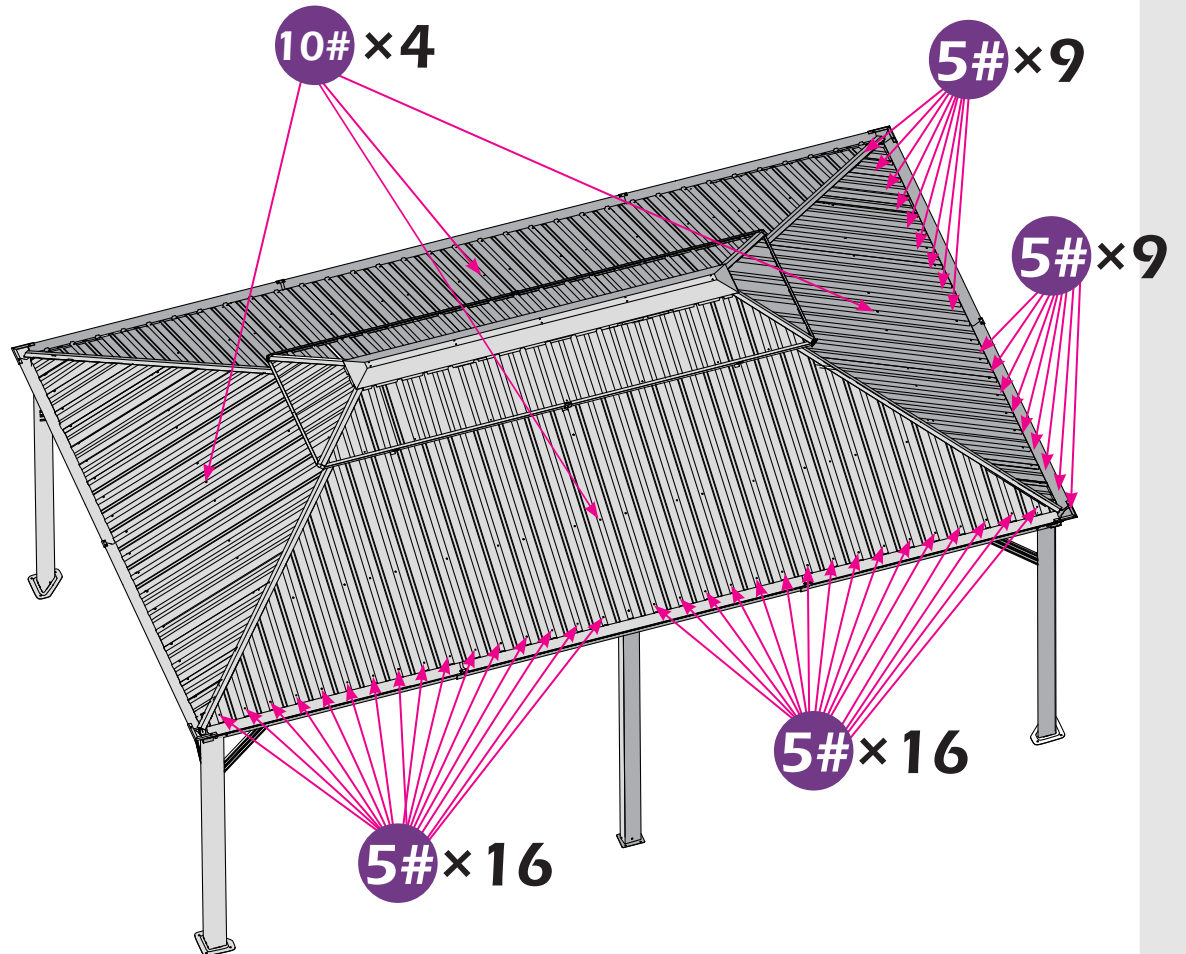
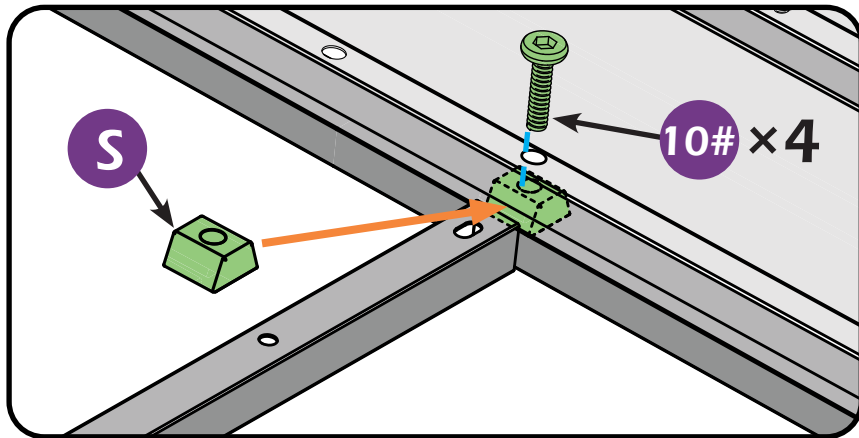
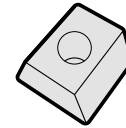

STEP 3



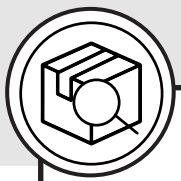

6#×8

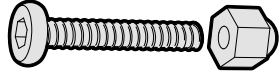

7#×48

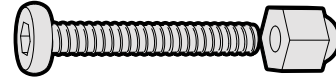

S×56

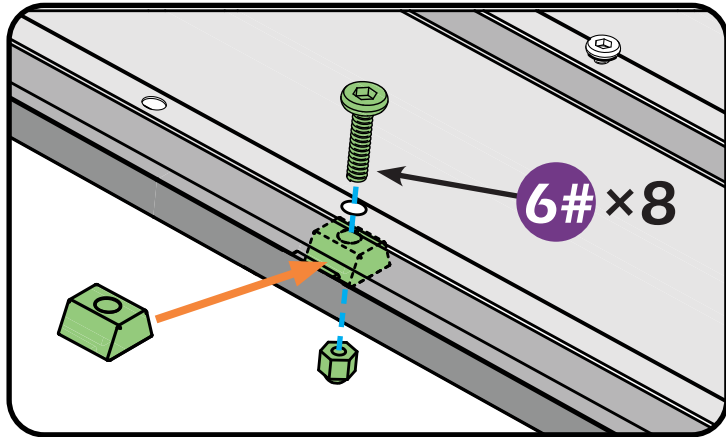
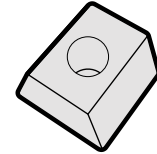

6#×8

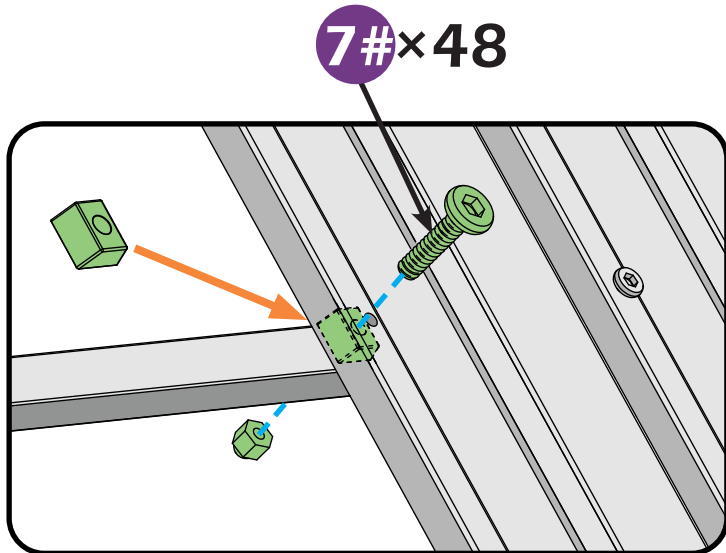

7#×48

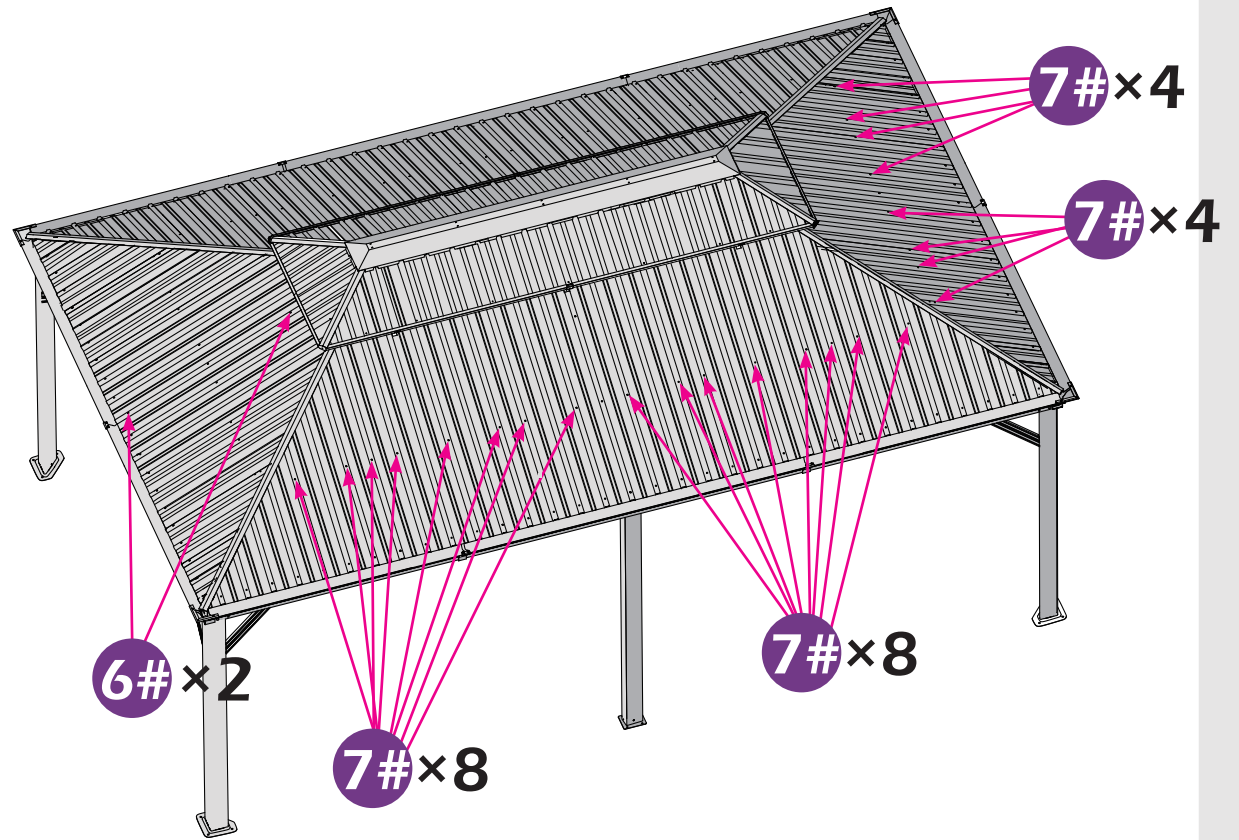

**STEP 3**

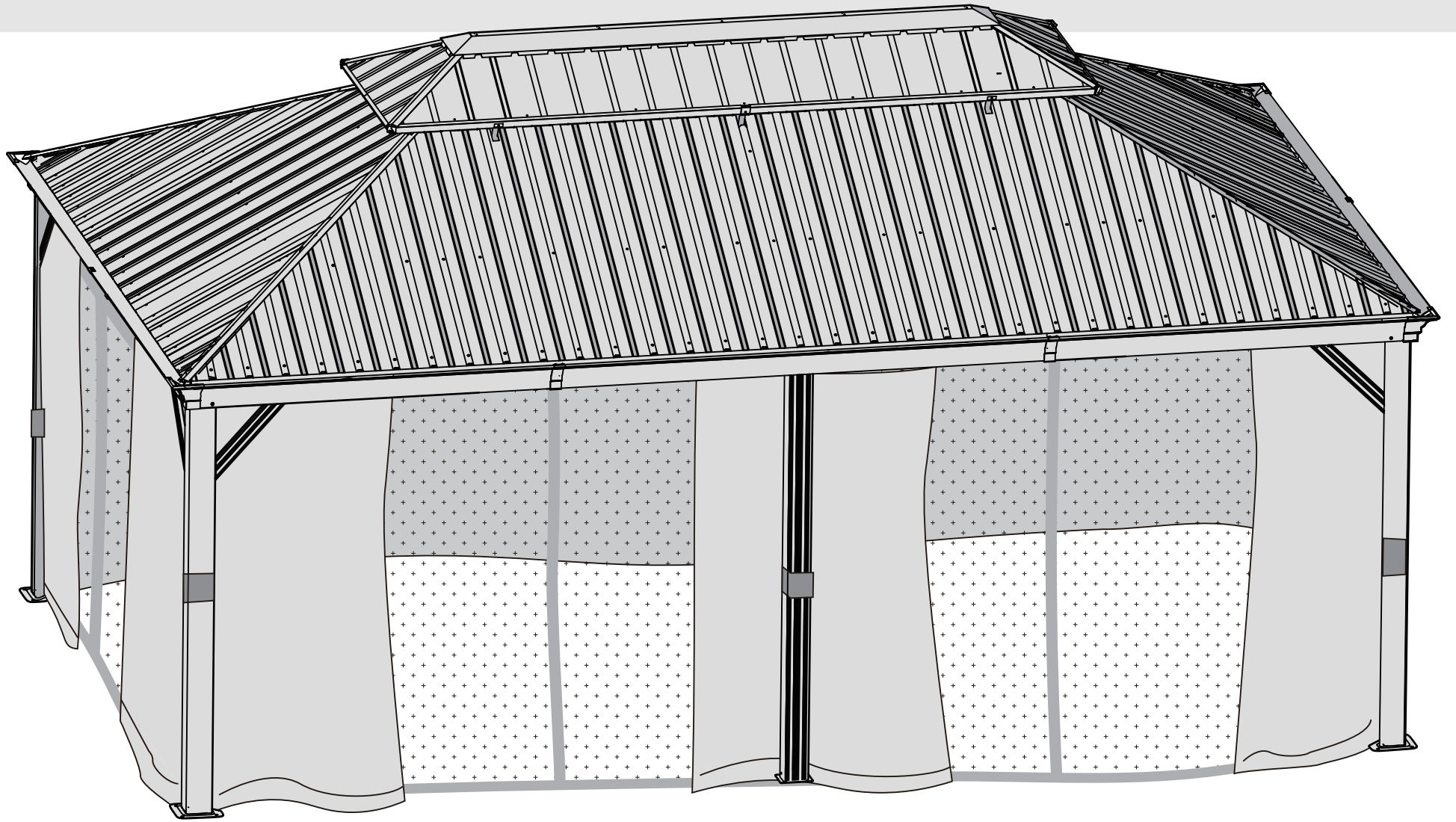

**STEP 4**



C1 × 2



1# × 20

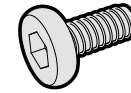

D1 × 2

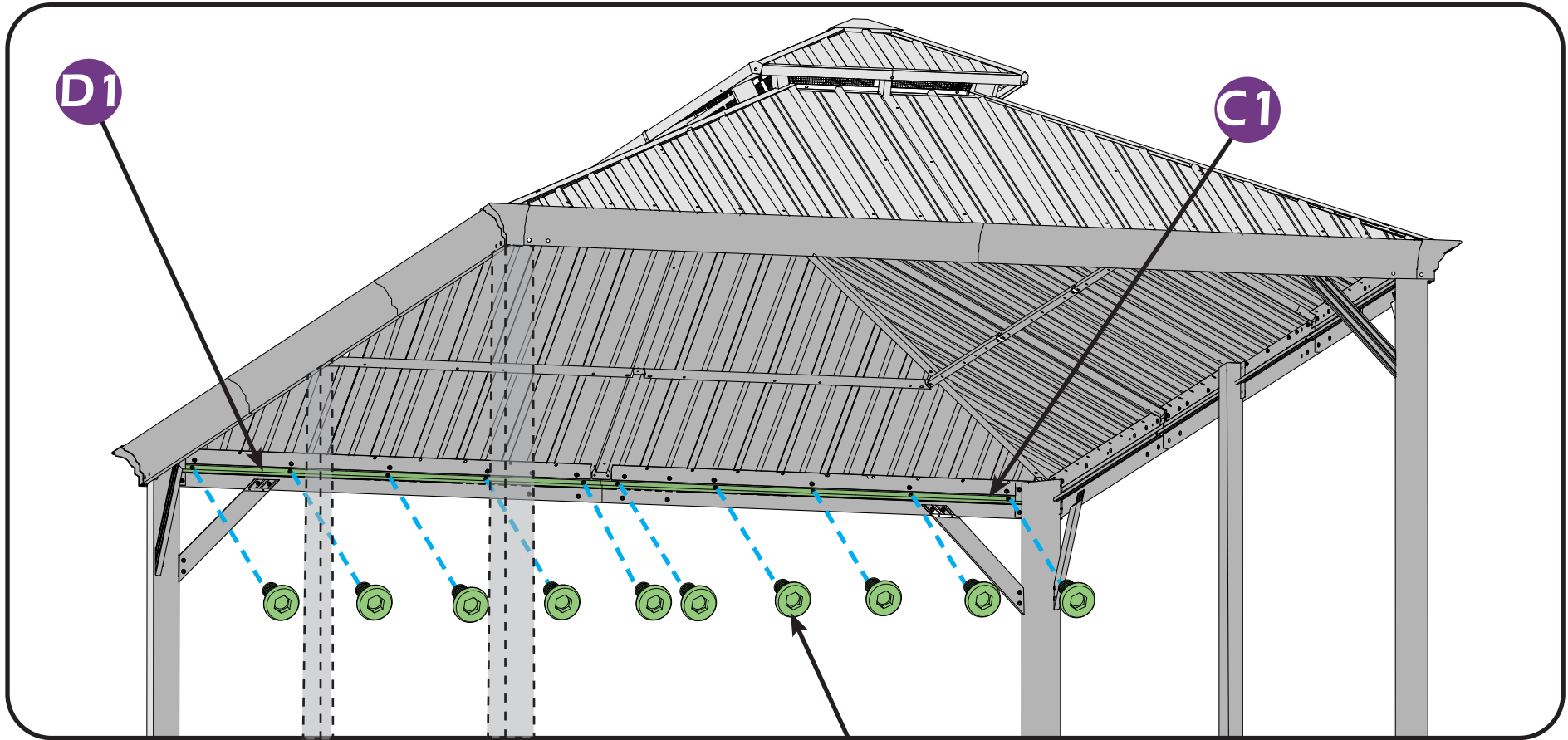

1# × 10

**STEP 4**



**C1** × 2

**E1a** × 2

**1#** × 36

**D1** × 2

**E1b** × 2

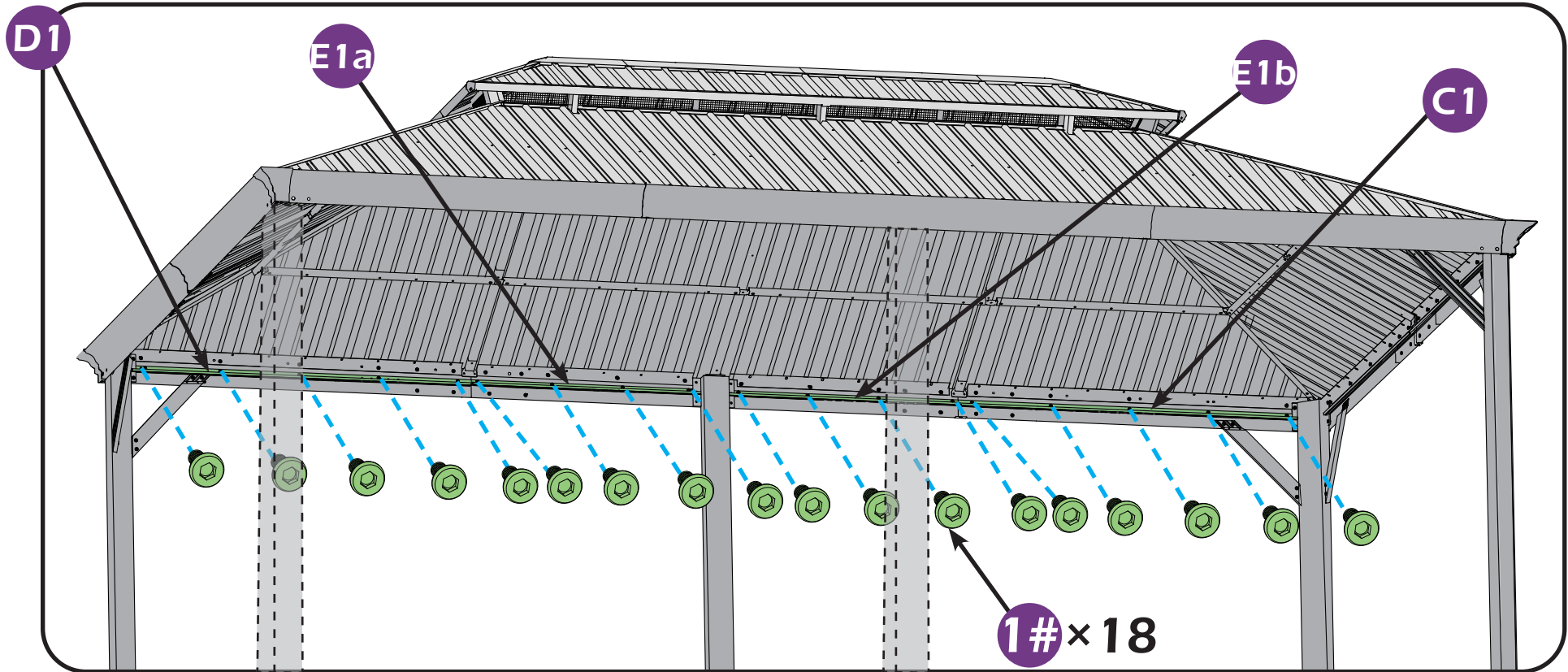
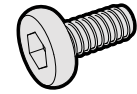

## STEP 4



4#×56

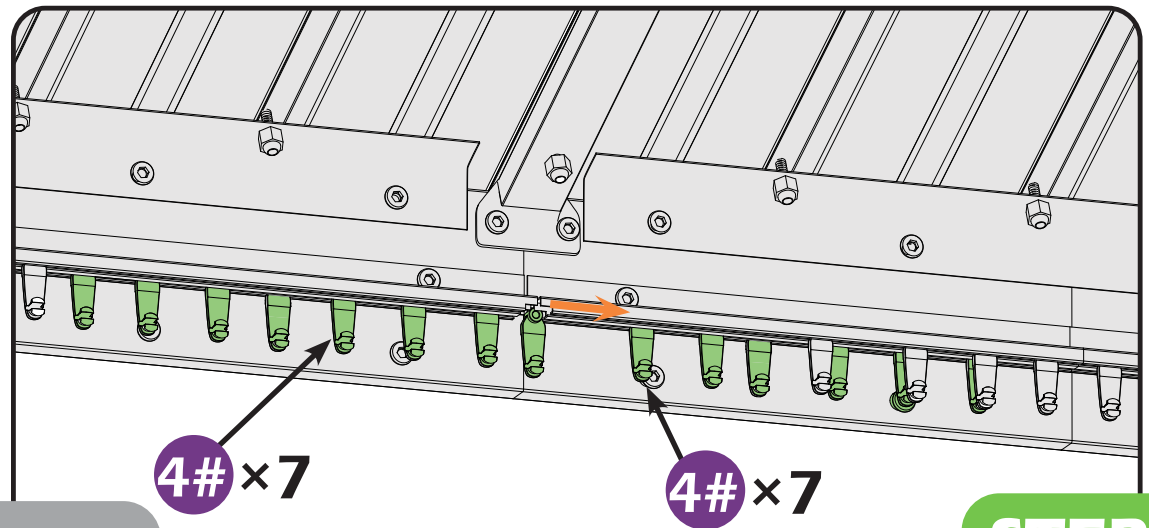
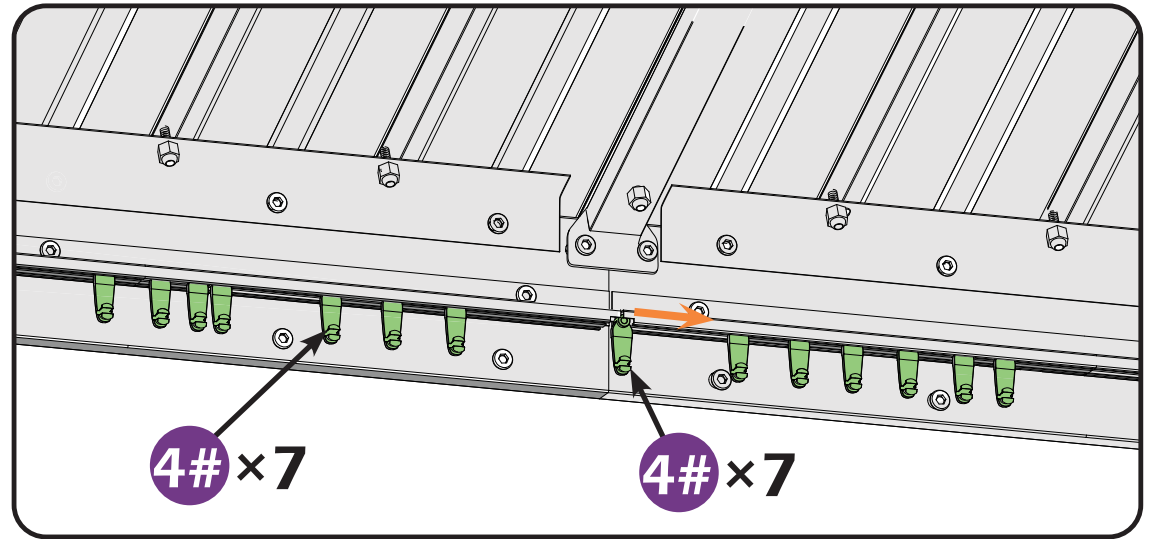
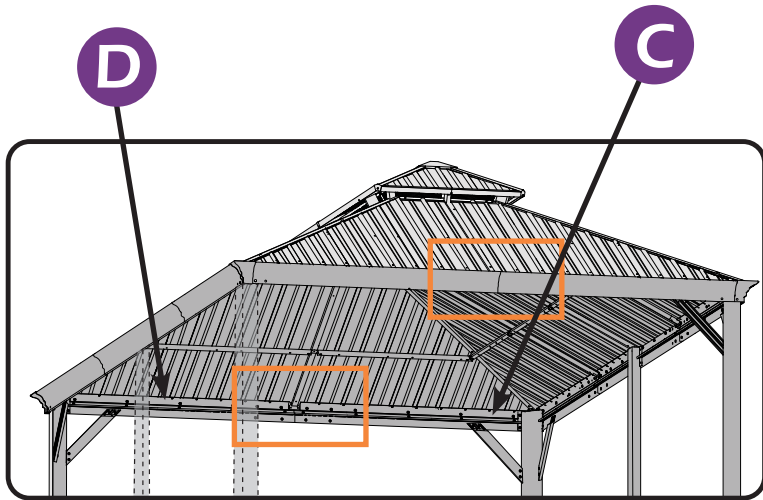
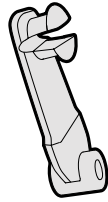

Here are two rails for curtains and netting .

**STEP 4**



4#×48

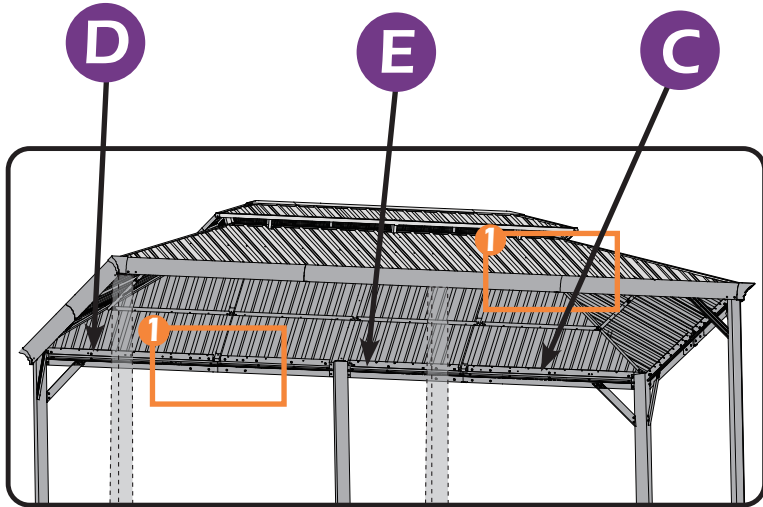
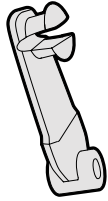

1

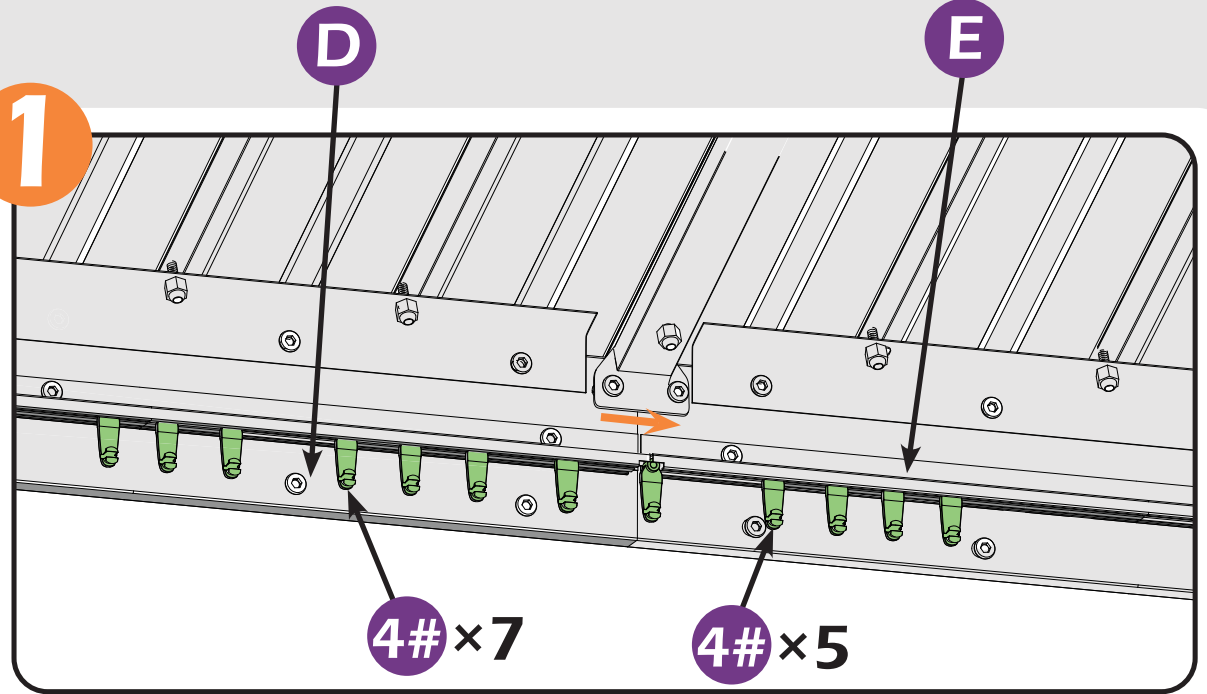

1

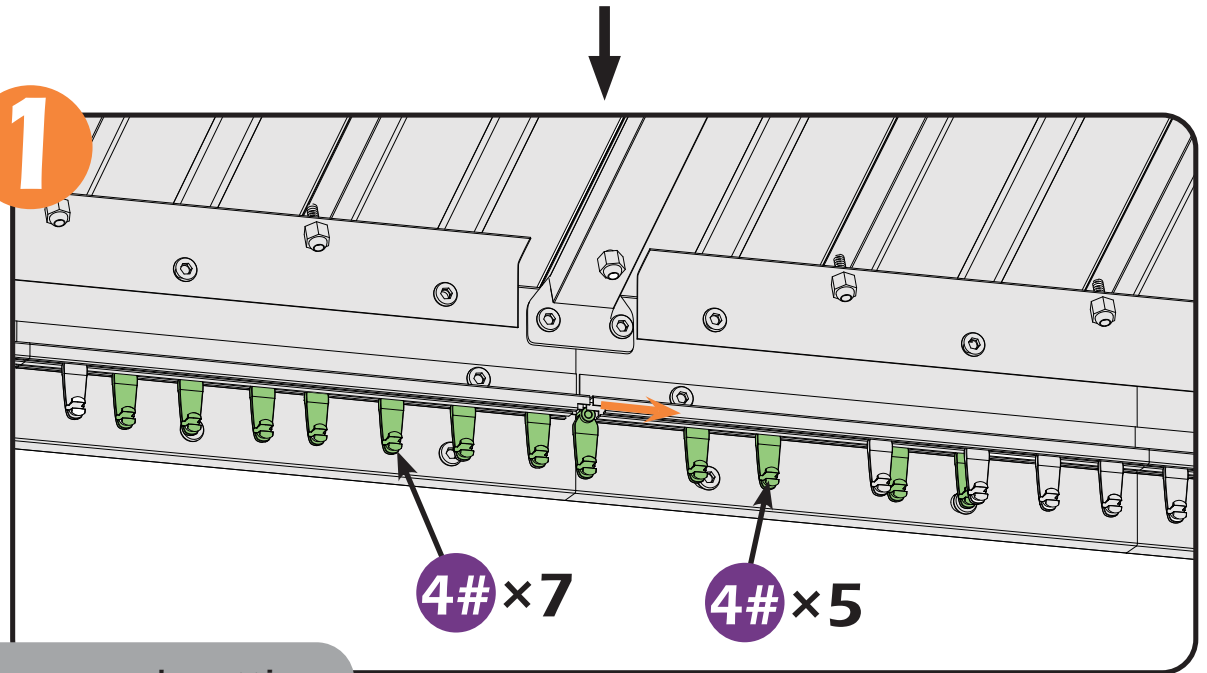

## STEP 4

Here are two rails for curtains and netting.



4# × 48

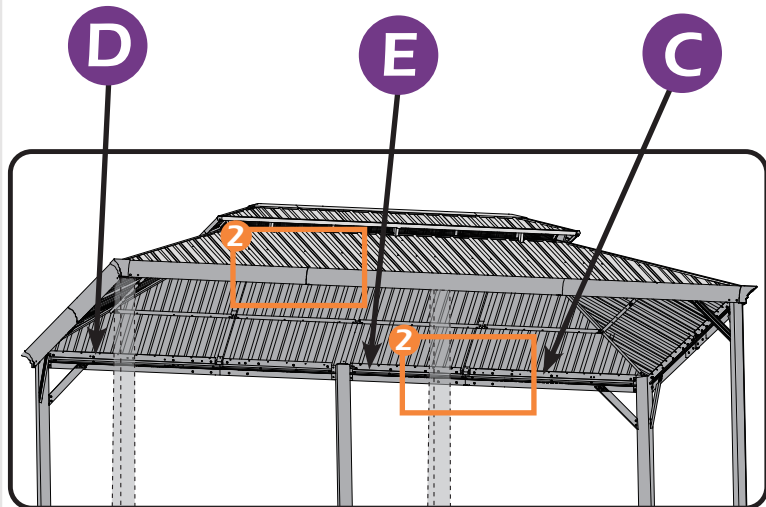
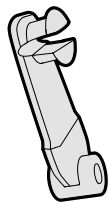

2

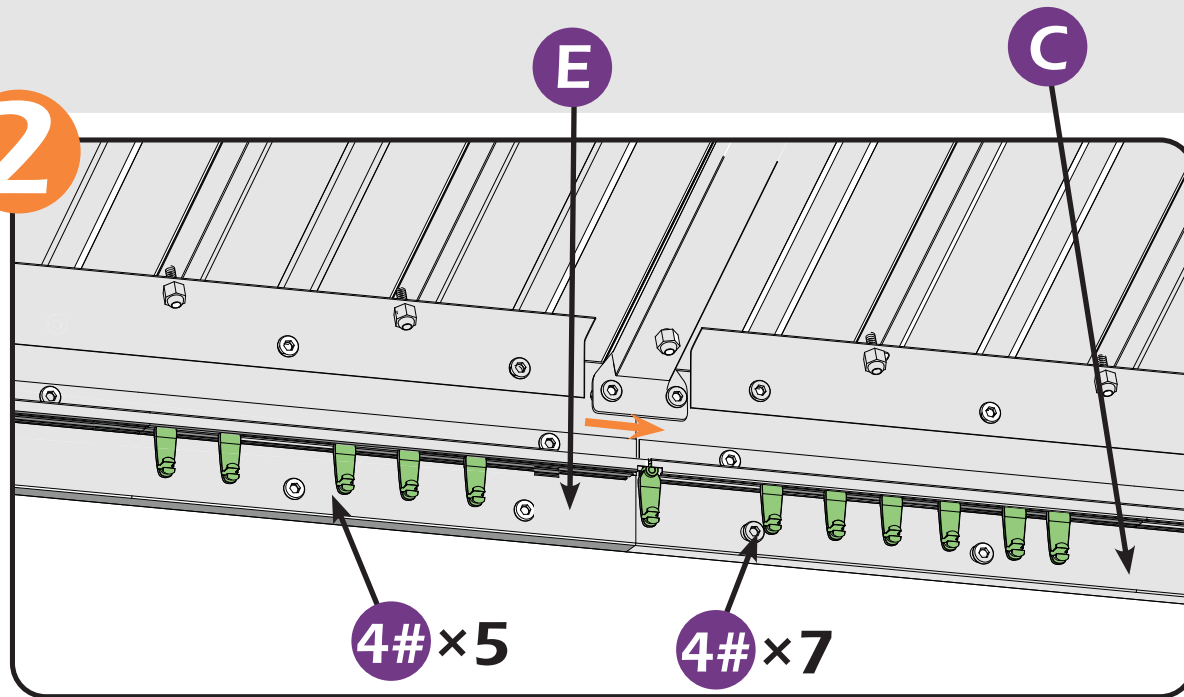

2

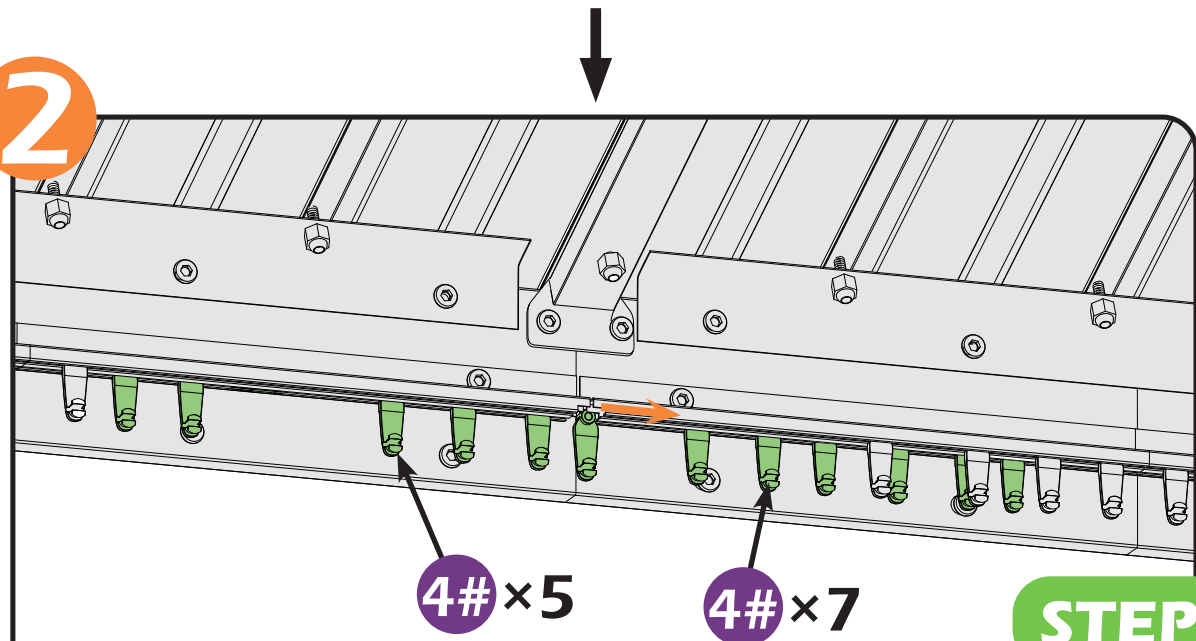

STEP 4

Here are two rails for curtains and netting.



H×6

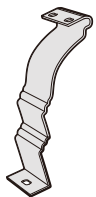

H1×6

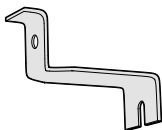

8#×6

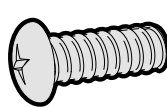

9#×12

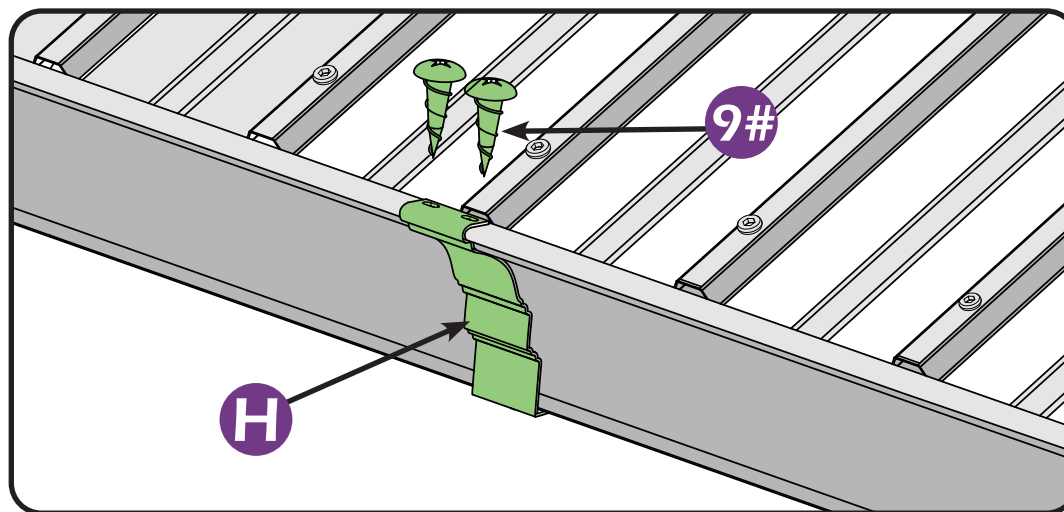
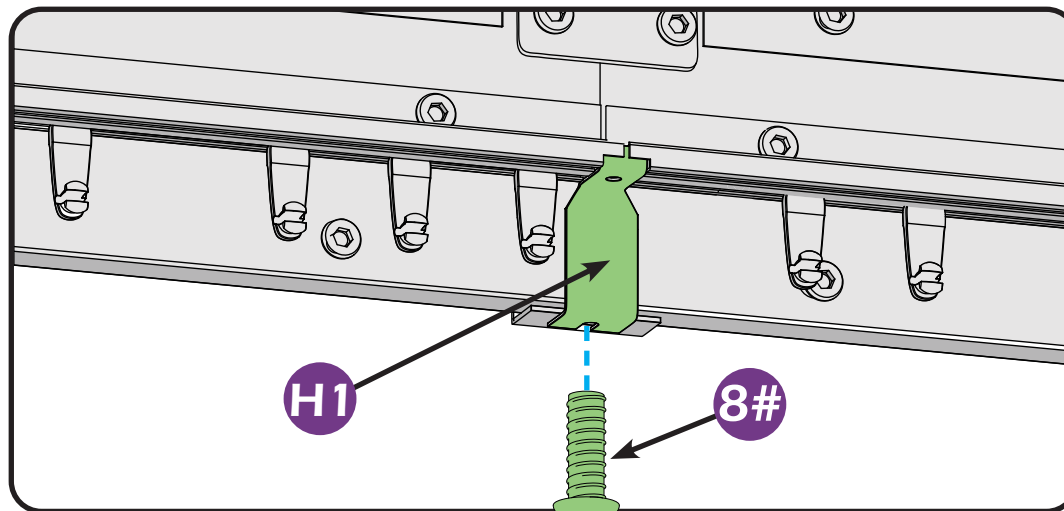
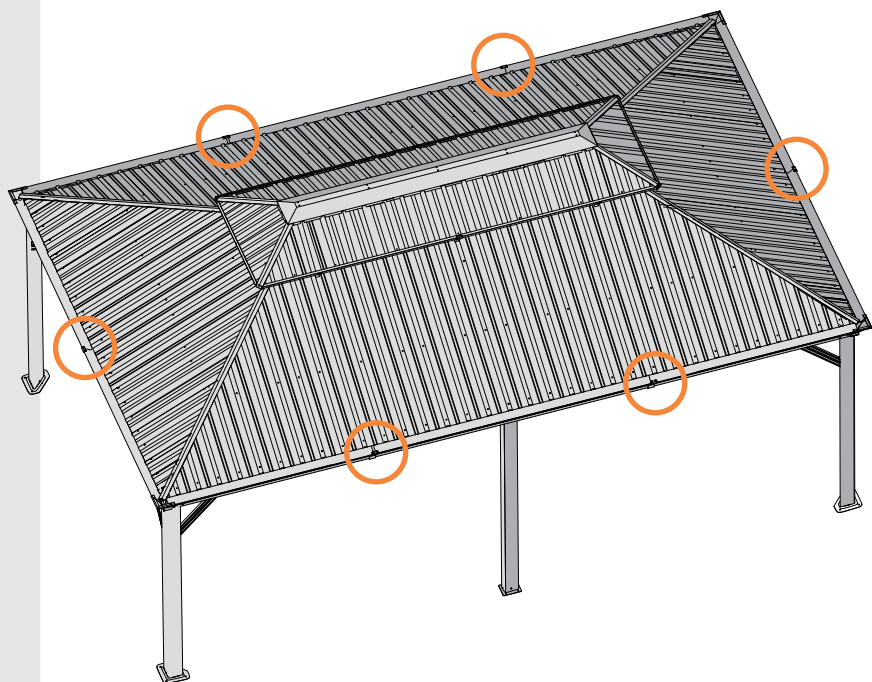
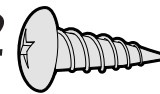

**STEP 4**





H2 x 1

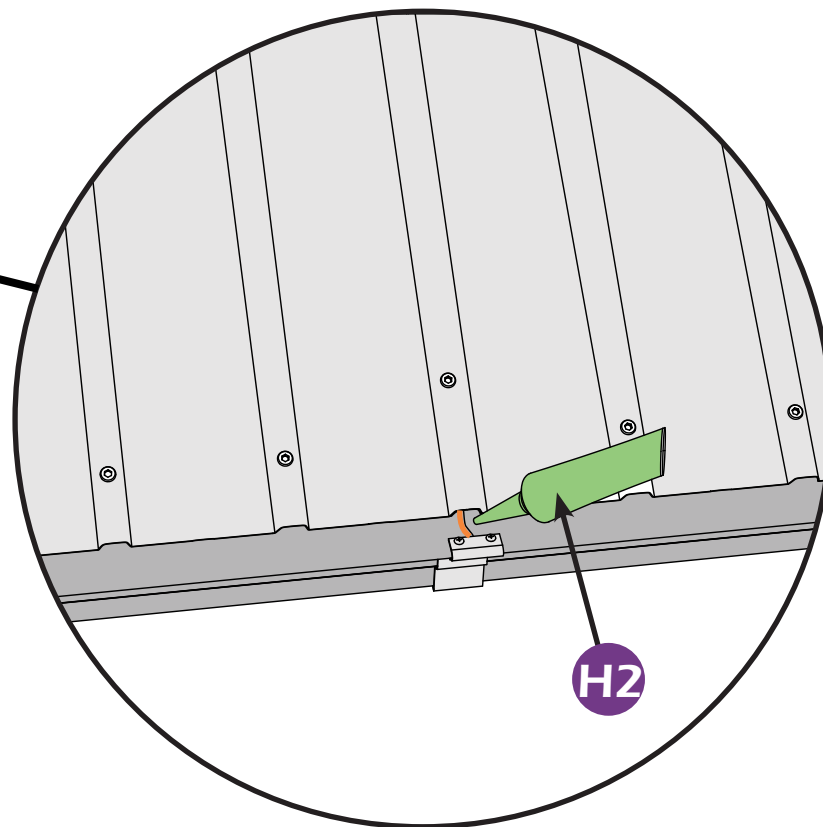
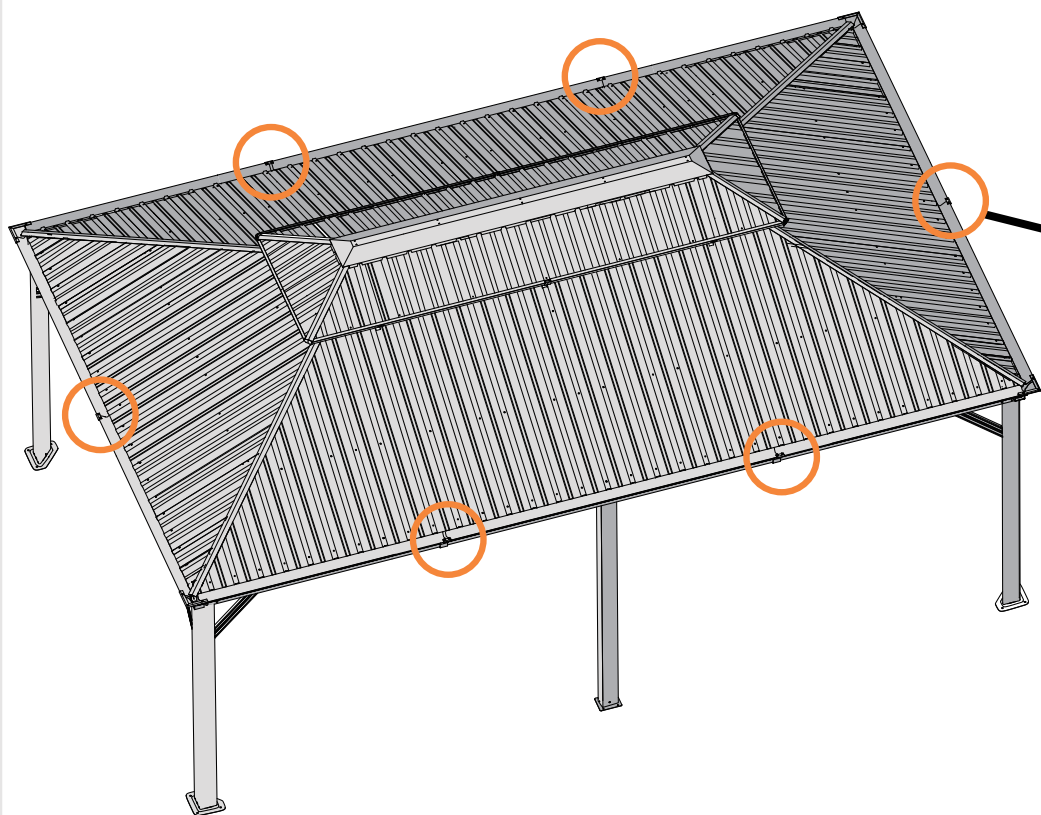
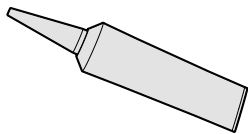

**STEP 4**



Y × 4

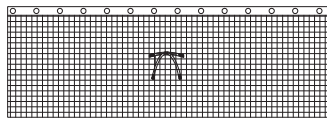

Ya × 4



Y1 × 2

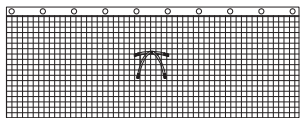

Y1a × 2

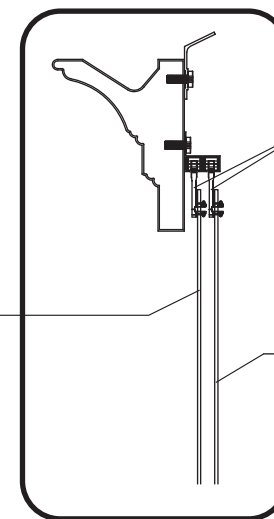
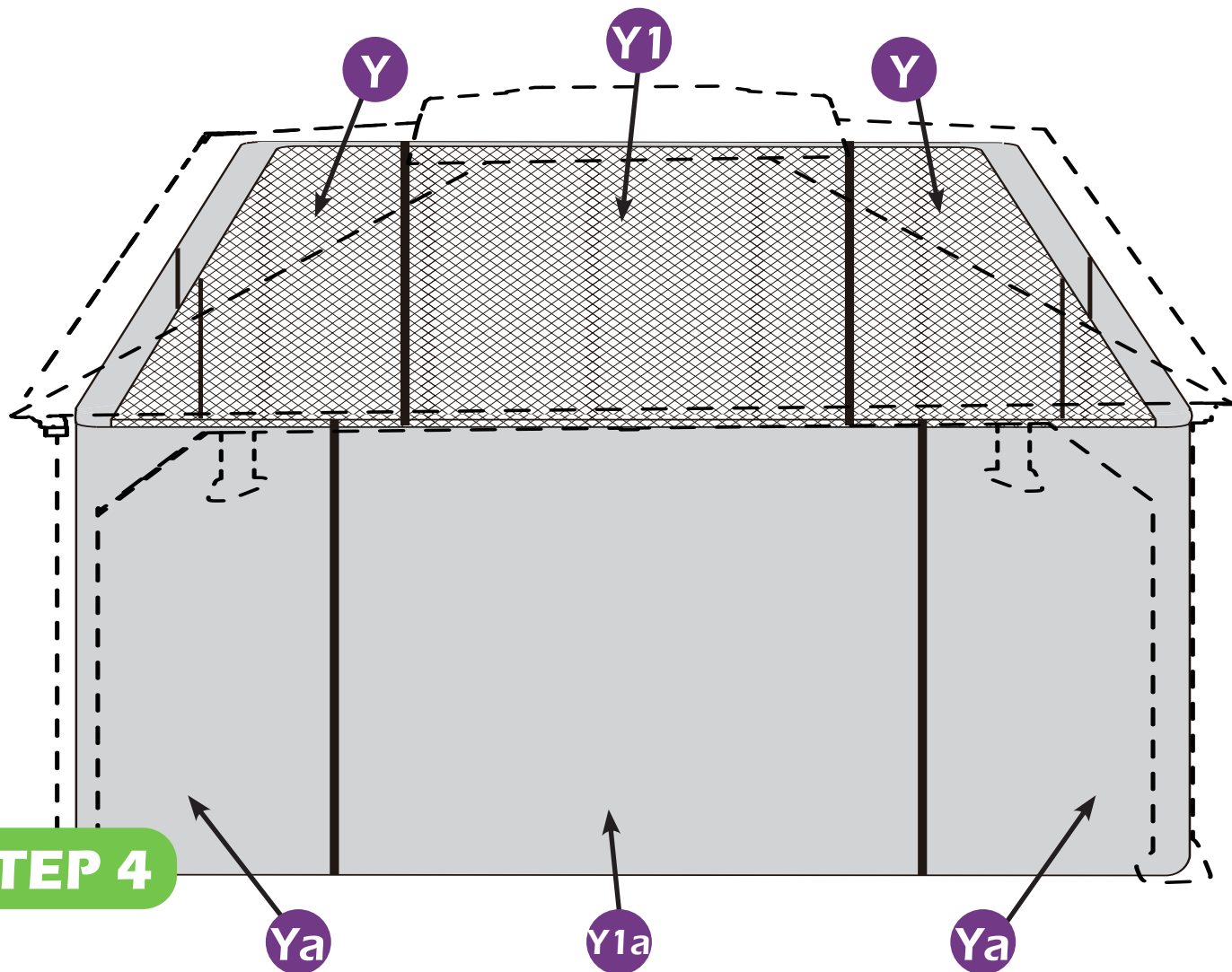
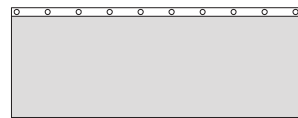

4#

Ya & Y1a

Y & Y1

Pictures below indicate the number of holes on the curtains/netting, each hole is match to one hook.

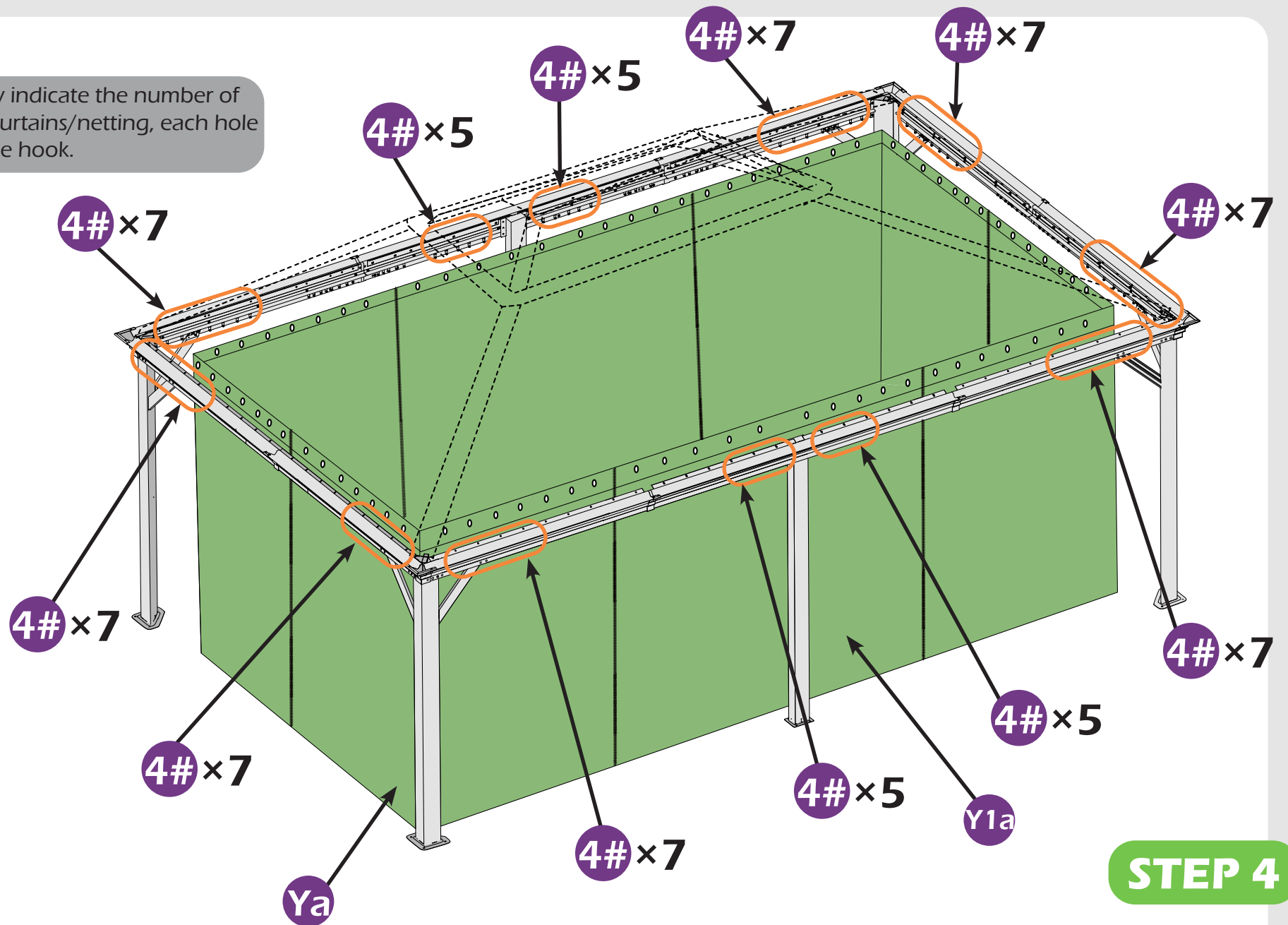

Pictures below indicate the number of holes on the curtains/netting, each hole is match to one hook.

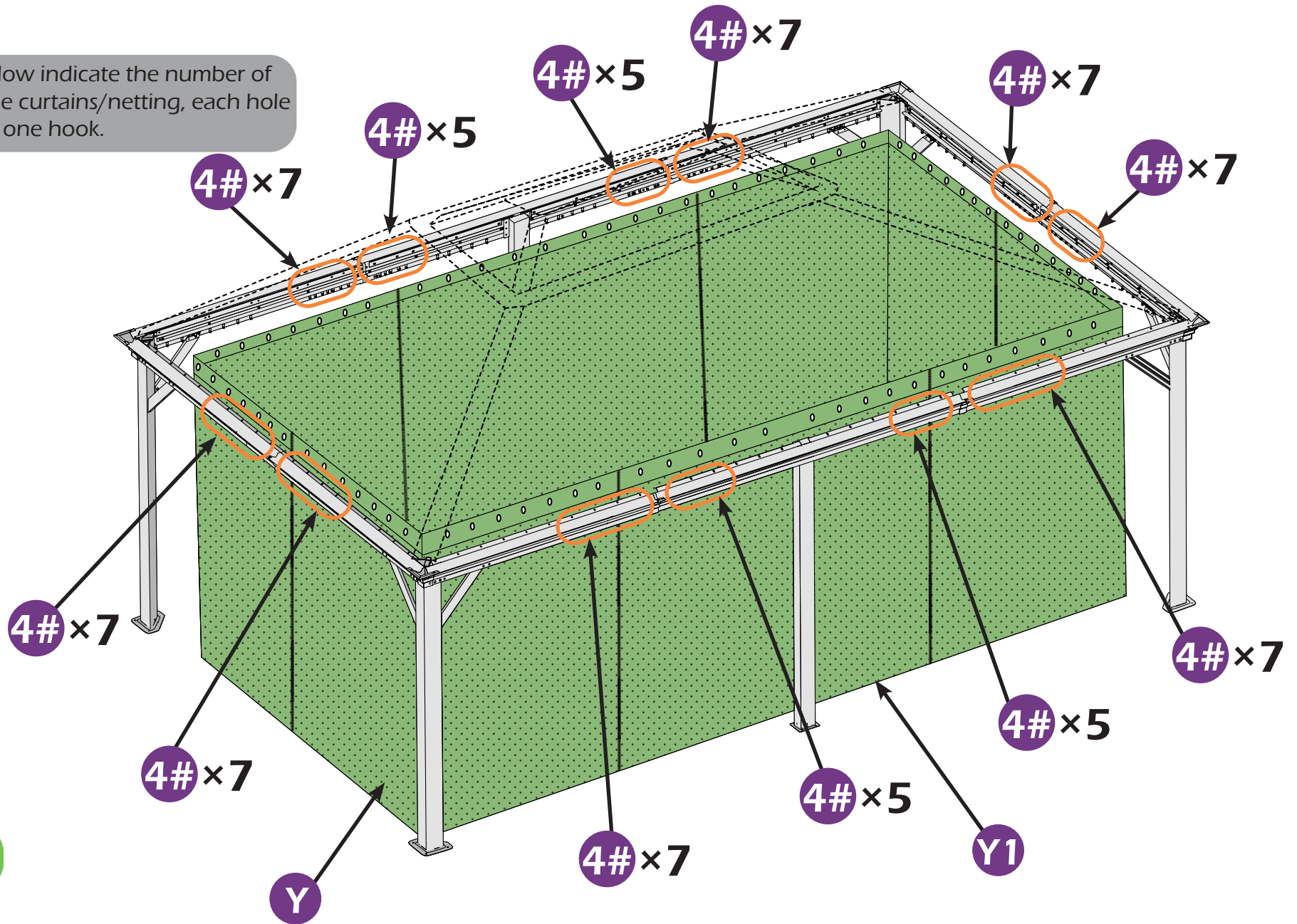

## STEP 4

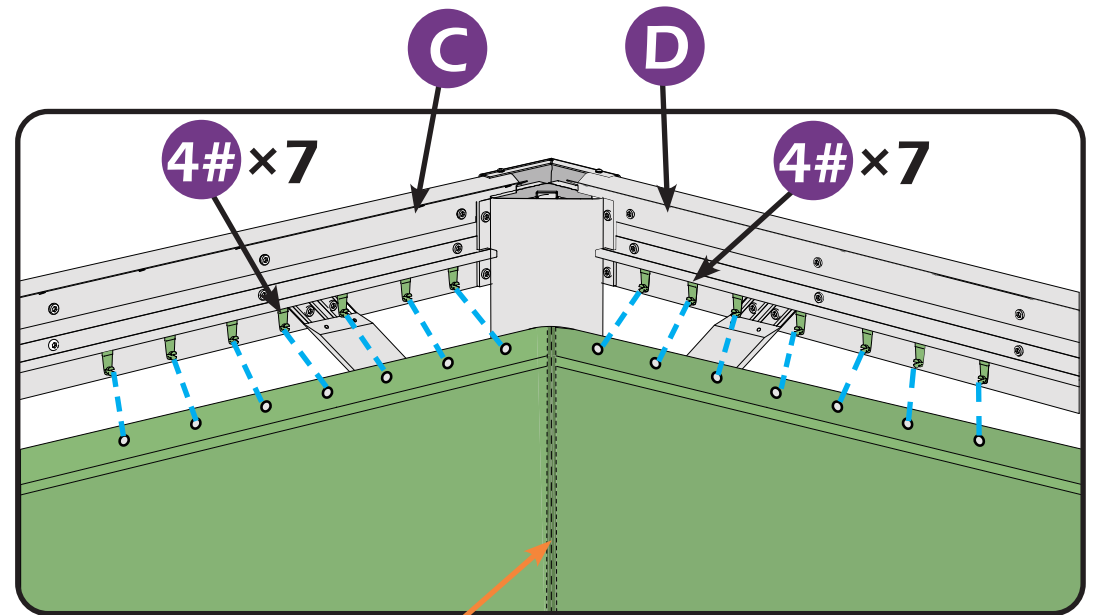
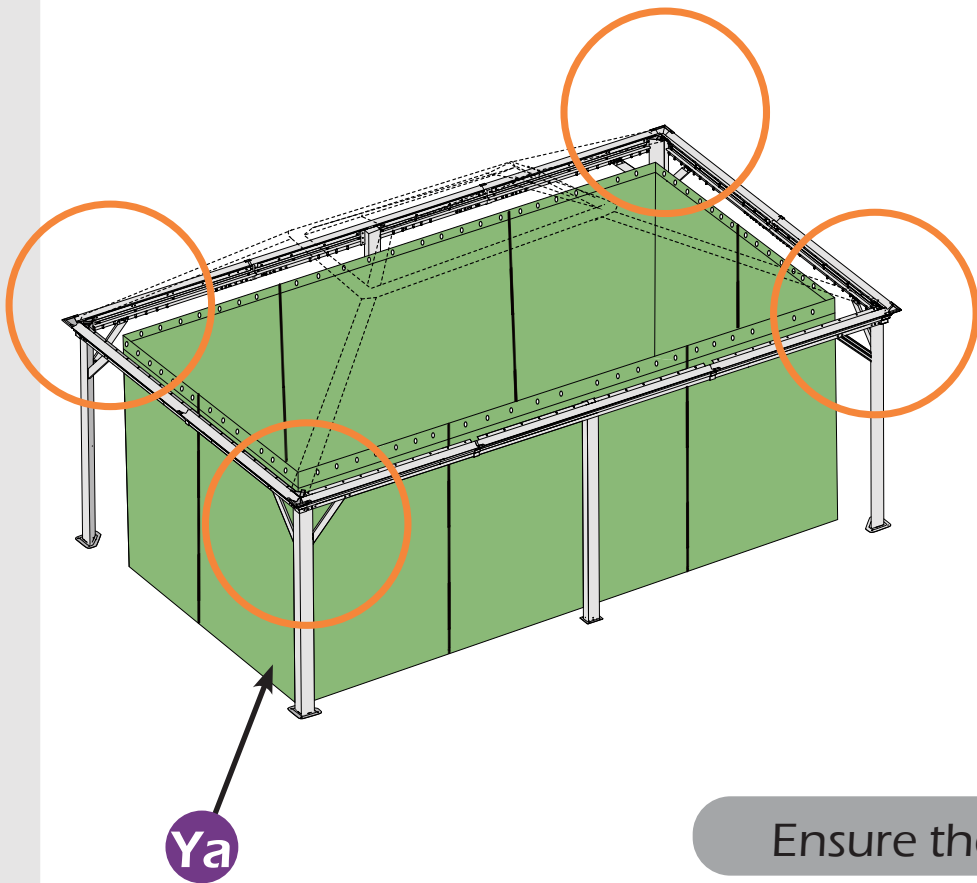

Ensure the suture line close to the pole

**STEP 4**

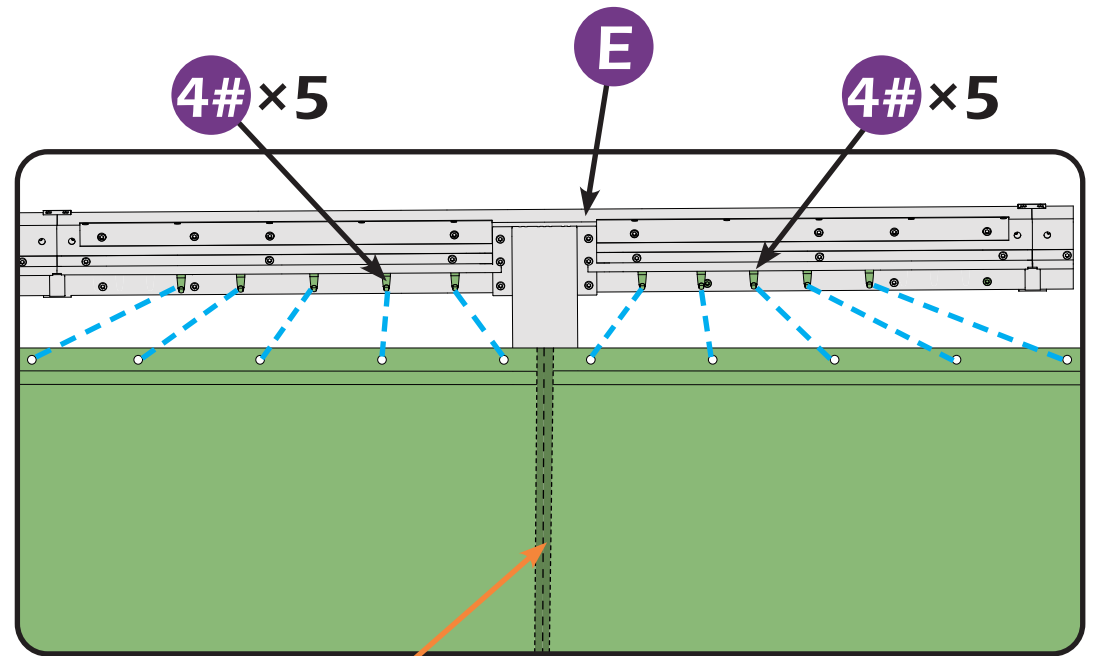
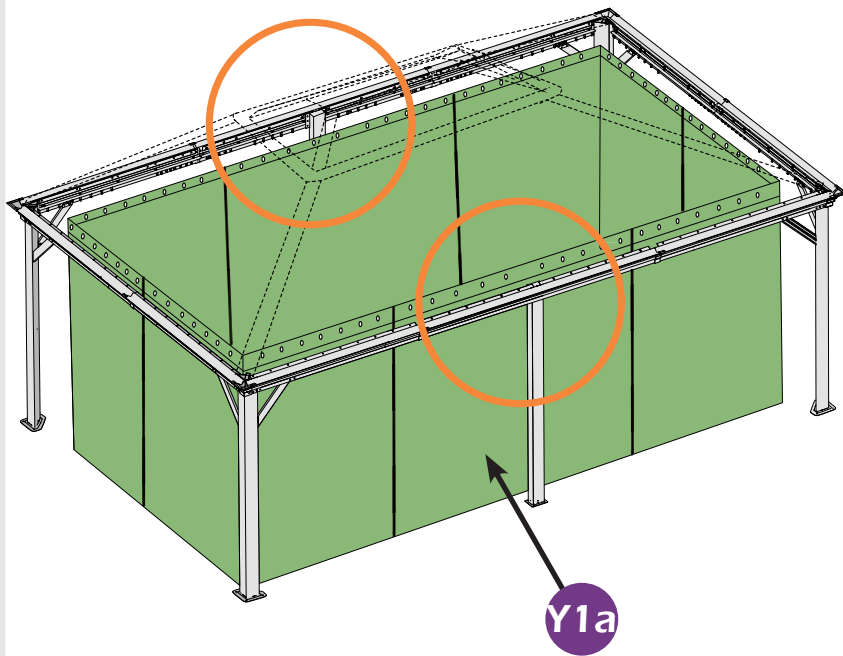

Ensure the suture line close to the pole

## STEP 4

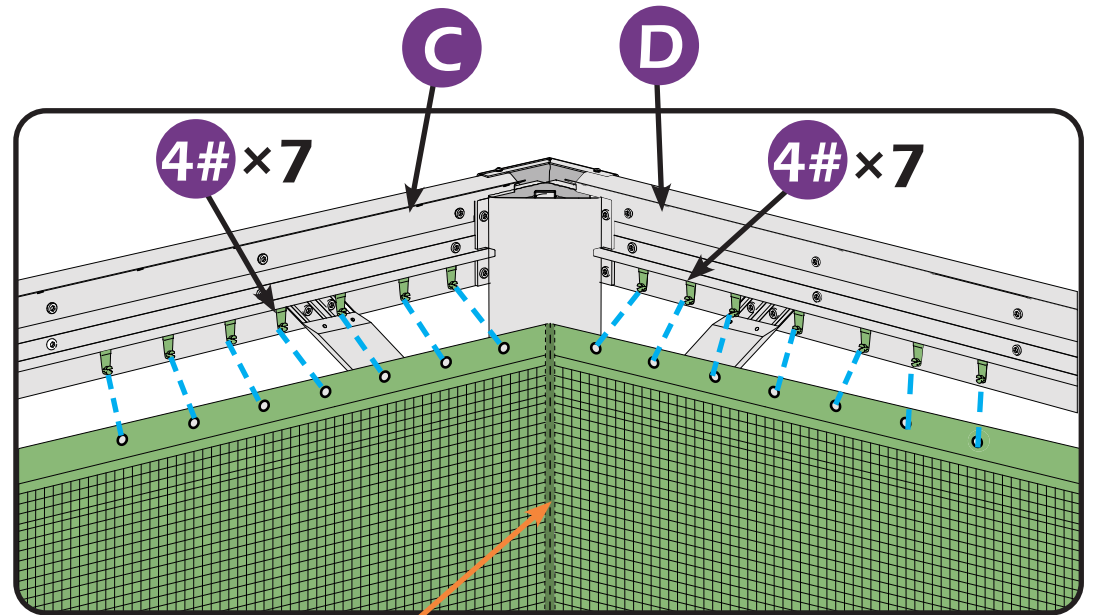
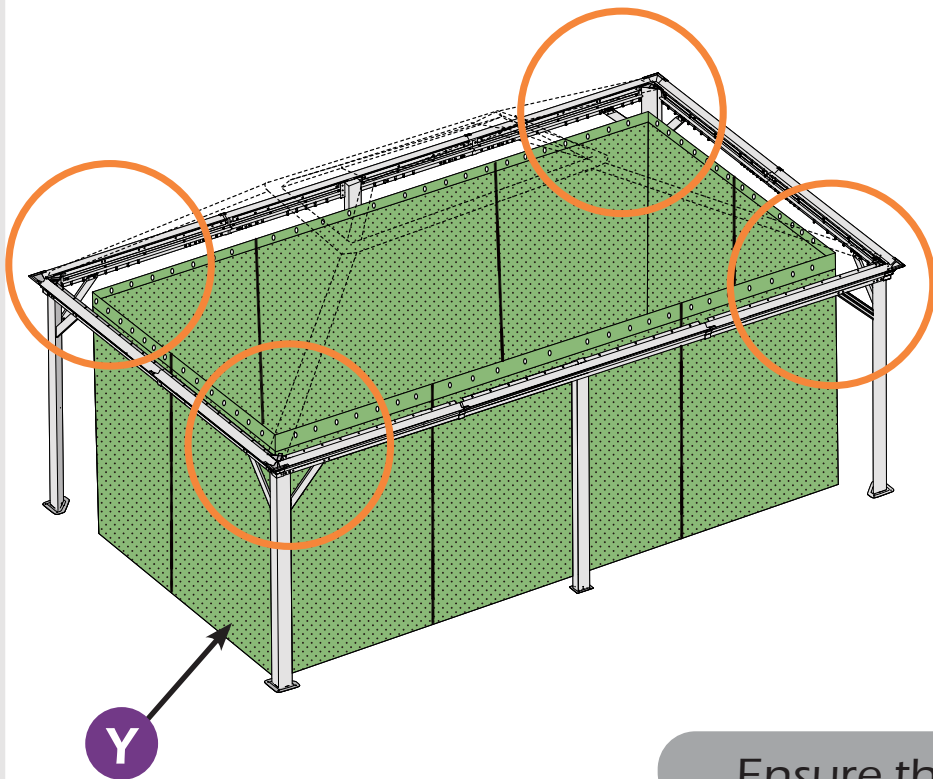

Ensure the suture line close to the pole

**STEP 4**

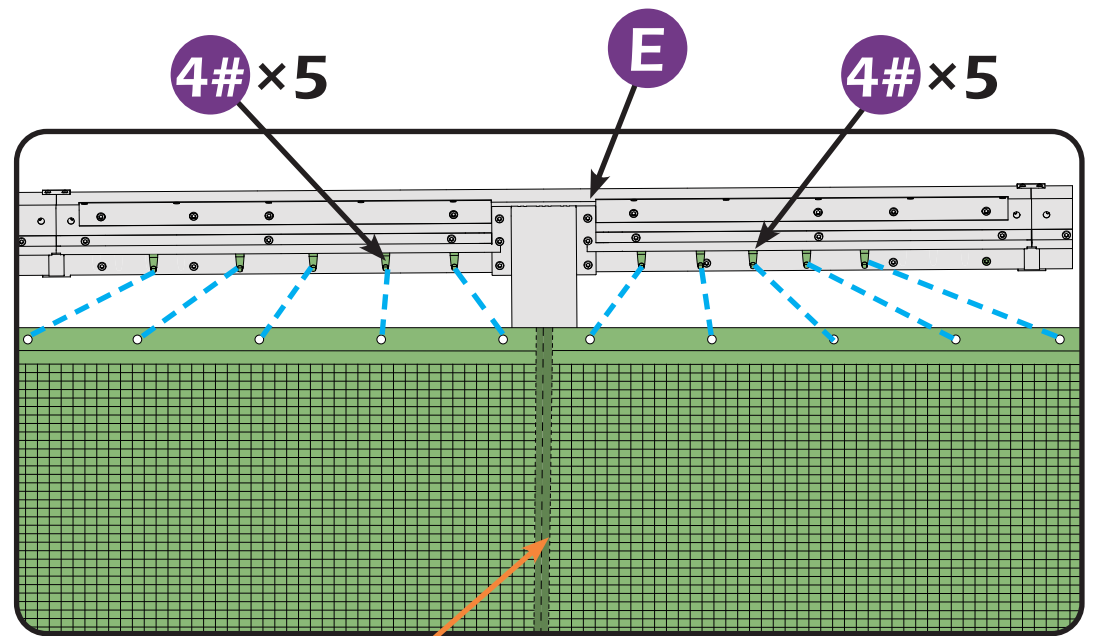
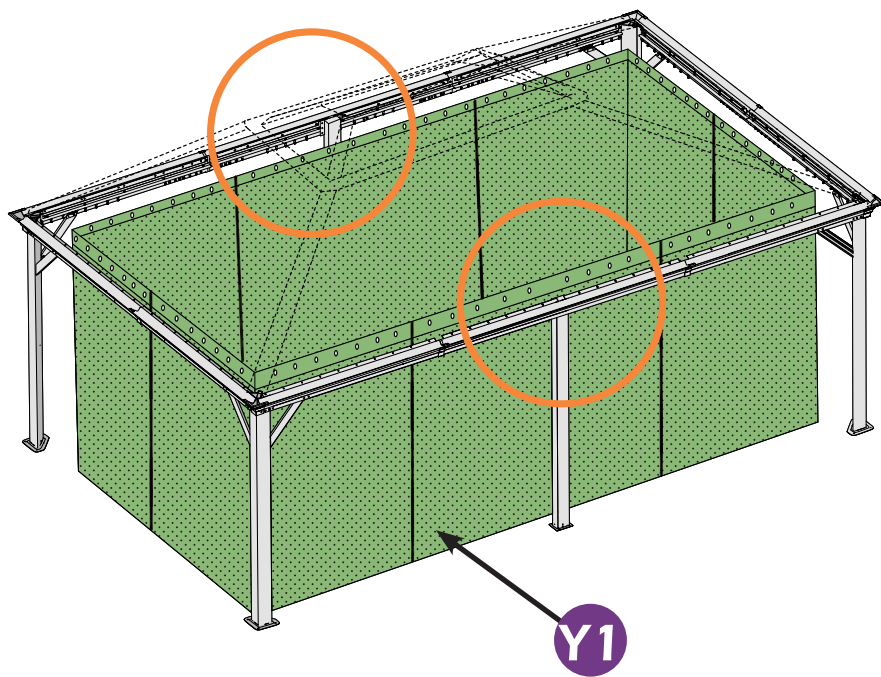

Ensure the suture line close to the pole

**STEP 4**



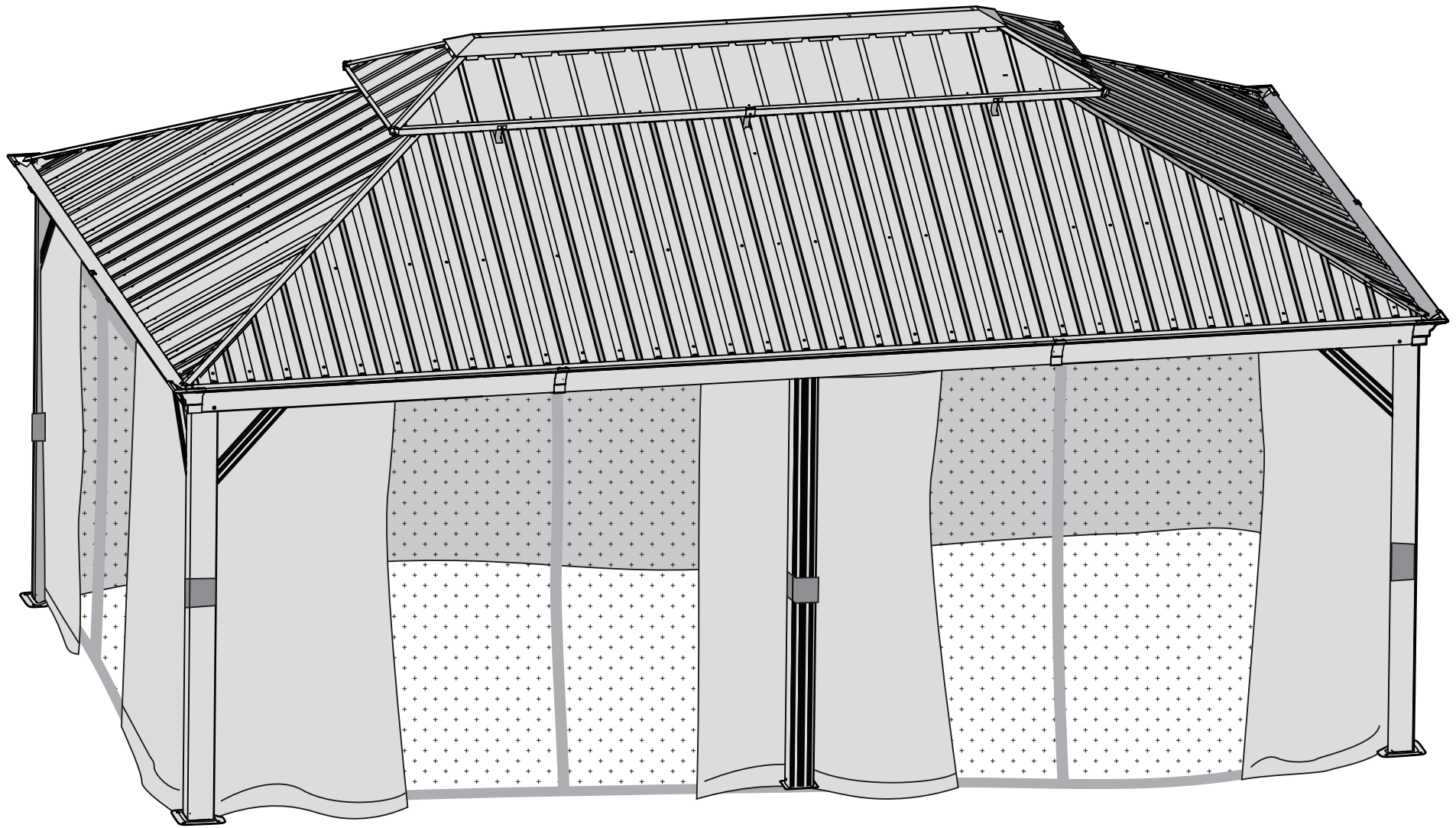

**STEP 4**

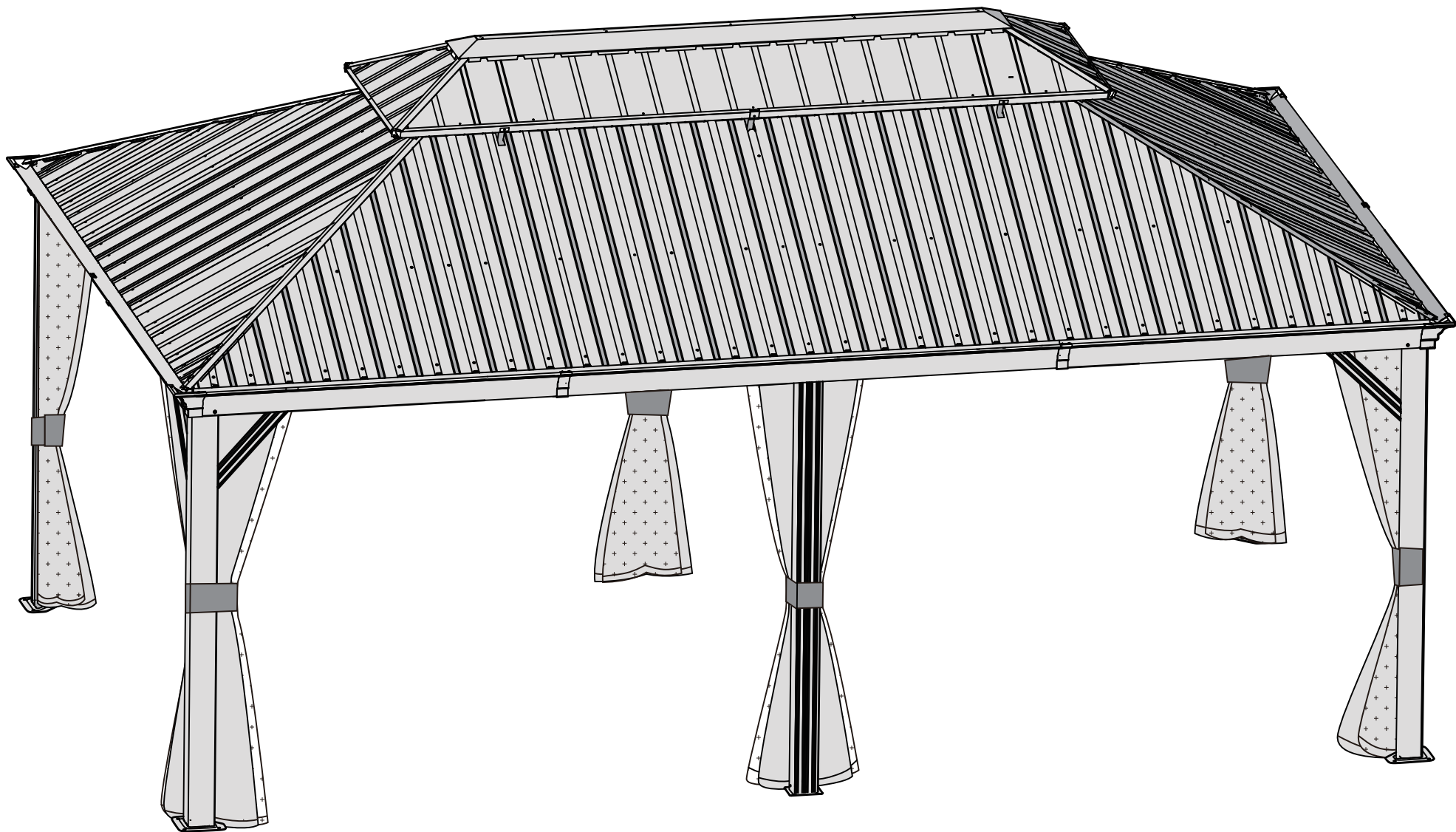

**STEP 4**

## **Care and Cleaning**

Wash frame parts and fabric with mild soap and water, rinse thoroughly.

Dry frame completely and allow the fabric to drip dry.

Do not use bleach, acid, or other solvents on the fabric or frame parts.

Please inspect and tighten all bolts or fasteners on a regular basis to ensure proper performance and safety of your gazebo.

# Warranty

## Frames

Frames constructions are warranted to be free from defects in material and workmanship for 1 year from item purchased. Damage to frame from negligence won't be covered by this warranty.

## Netting

Netting are warranted to be free from defects in material and workmanship for 1 year from item purchased. Damage from exposure to chemicals (including but not only oils ,spills, fluids) won't be covered by this warranty.

## Bolts & nuts

Bolts and nuts are warranted to be free from defects in material and workmanship for 1 year from item purchased. Damage from exposure to chemicals (including not only oils ,spills, fluids) won't be covered by this warranty.

## Warranty Limitation

This warranty is for the original purchase order only. (Order number required). This warranty is non-transferable. Domi outdoor living is responsible for the free replacement part including shipping charges for the 1 year warranty.

## Warranty Exclusion

This warranty does not cover products subject to negligence, abuse usage, inappropriate installation. Domi outdoor living reserves the right to explain warranty exclusions. When the replacement item is applied, the 1 year warranty automatically expires. Please feel free to contact us for applying warranty.



RESORT COMFORT IN YOUR  
OWN BACKYARD

**Support:**



Email: [domiservice01@outlook.com](mailto:domiservice01@outlook.com)

Please tell us your order ID when contact.

Attach photos of damaged part for instant reply.