

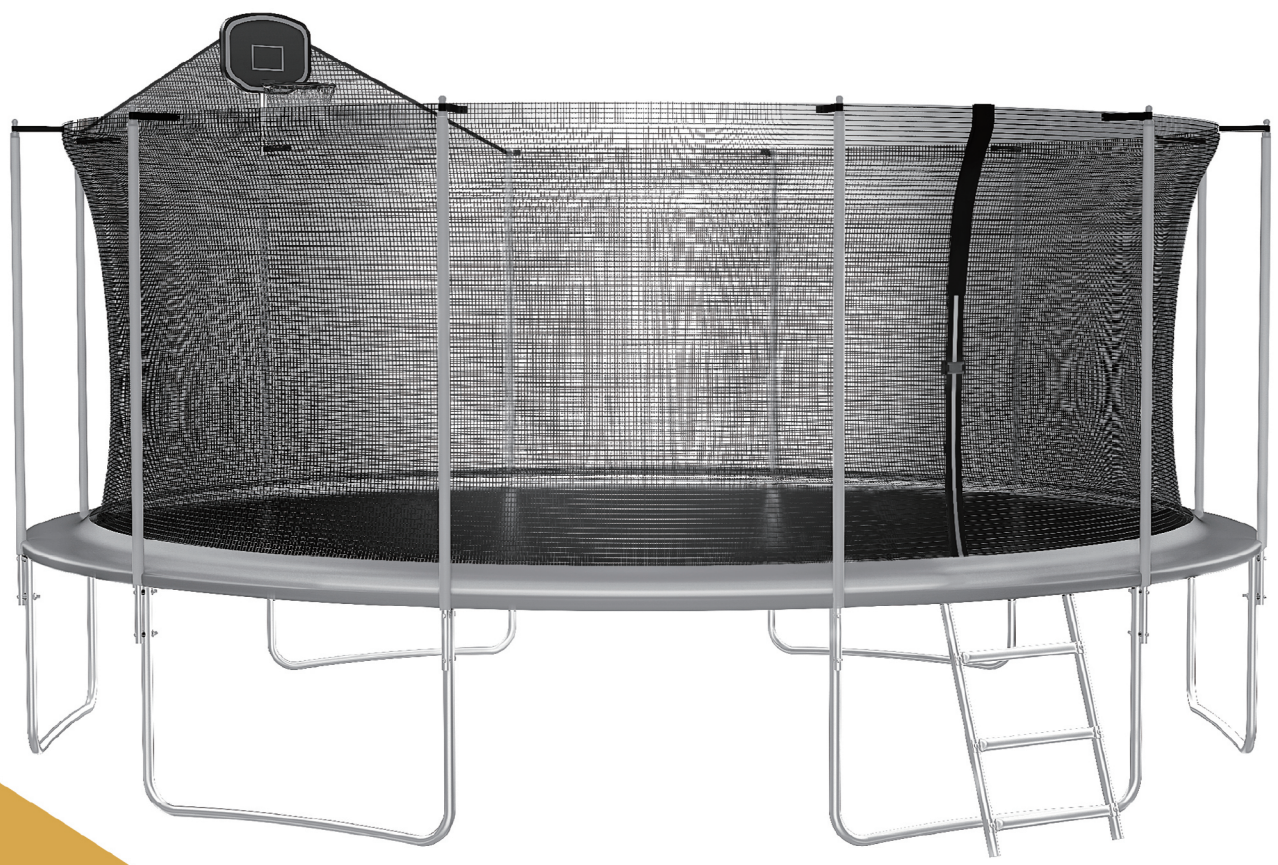

FIZITI Trampoline Assembly Instruction







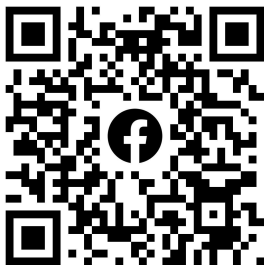





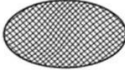

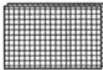
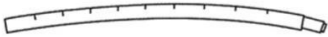

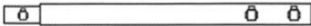
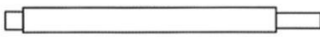
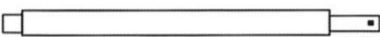
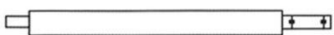

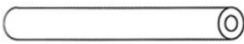

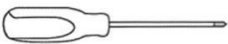
Experience Joyful Moments with FIZITI

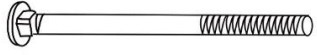
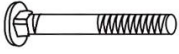

Welcome to FIZITI FAMILY ! Here, you can share fun Videos of you using FIZITI products, discover new items, and find discount coupons. It's also a great place to meet friends who share similar interests. Join us to enjoy a vibrant community where you can connect with others, explore exciting finds, and have a great time . We look forward to seeing you!

Trampoline Package List

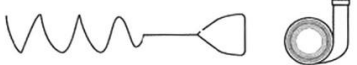









Number	Diagram	Part Name	12FT QTY	14FT QTY	15FT QTY	16FT QTY
1		Jumping Mat	1	1	1	1
2		Spring Cover Pad	1	1	1	1
3		Safety Enclosure Net	1	1	1	1
4		Top Rail	8	8	12	12
5		T-shaped Connector	8	8	12	12
6		Base Leg	4	4	6	6
7		Leg Extension	8	8	12	12
8A		Top Frame Tube	7	7	11	11
8B		Board Support Tube	1	1	1	1
9A		Bottom Frame Tube	7	7	11	11
9B		Bottom Frame Tube	1	1	1	1
10		Foam (come with #8, #9)	16	16	24	24
11		Spring	72	80	96	108
12		Loading Spring Tool	2	2	2	2
13		Screwdriver	1	1	1	1
14		Net Pole Cap	8	8	12	12

Number	Diagram	Part Name	12FT QTY	14FT QTY	15FT QTY	16FT QTY
15		Net Pole Caps Screw	2	2	2	2
16		Long Rope (Fix Enclosure Net Bottom)	1	1	1	1
17		Long Screw	16	16	24	24
18		Short Screw	8	8	12	12
19		Washer	24	24	36	36
20		Black Gap Spacer	16	16	24	24
21		Tie Down Stake Kit	4	4	4	6
22		Lock Nut	24	24	36	36



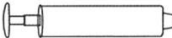

For 16ft trampoline, we added six tubes to reinforce the frame of the entire trampoline. Shows below:

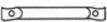

Basketball Hoop Part List

Number	Diagram	Part Name	12FT QTY	14FT QTY	15FT QTY	16FT QTY
23		Basketball Hoop Ring	1	1	1	1
24		Basketball Hoop Board	1	1	1	1
25		Basketball Hoop Net	1	1	1	1
26		Board Fix Pin B	1	1	1	1
27		Board Fix Pin C	1	1	1	1
28		Rubber Ball	1	1	1	1
29		Rubber Ball Pump	1	1	1	1
30		Allen Tool	1	1	1	1
31		Short Screws for Board	4	4	4	4
32		Long Screws for Board	4	4	4	4

Lander Part List

Number	Diagram	Part Name	12FT QTY	14FT QTY	15FT QTY	16FT QTY
33		Ladder Pole	2	2	2	2
34		Step Pole	3	3	3	3
35		Ladder Screw	6	6	6	6
36		Washer	6	6	6	6
37		Lock Nut	6	6	6	6

Before assembly, prepare by

1, Ensure a suitable assembly location: Choose a flat, spacious area without any obstacles to assemble the trampoline. Make sure the area is clear of branches, power lines, or other potential hazards.

2, Clean the assembly area: Remove debris, stones, branches, etc., from the assembly area. Ensure the ground is dry, level, and free of sharp or hard objects.



3, Check trampoline parts: Carefully inspect all parts of the trampoline to ensure they are intact and complete. If there are any damaged or missing parts, contact the supplier promptly for replacement or repair.



4, Prepare necessary tools: According to the trampoline's assembly manual, gather the required tools such as wrenches, screwdrivers, etc. (We've provided tools for assembly, but you are more than welcome to use your own.)

5, Read the installation instructions: Thoroughly read the trampoline's assembly manual and ensure understanding of each step. Follow the instructions provided in the manual to assemble the trampoline step by step.

6, Seek assistance: Trampoline assembly usually requires two or more people to work together, so find a suitable helper to ensure safety and a smooth assembly process.

Please note that the specific steps for these preparations may vary depending on the trampoline model and brand. Make sure to carefully read and follow the corresponding assembly manual.

Frame Assembly



Step 1

Arrange all the top rails(#4) into a circle.

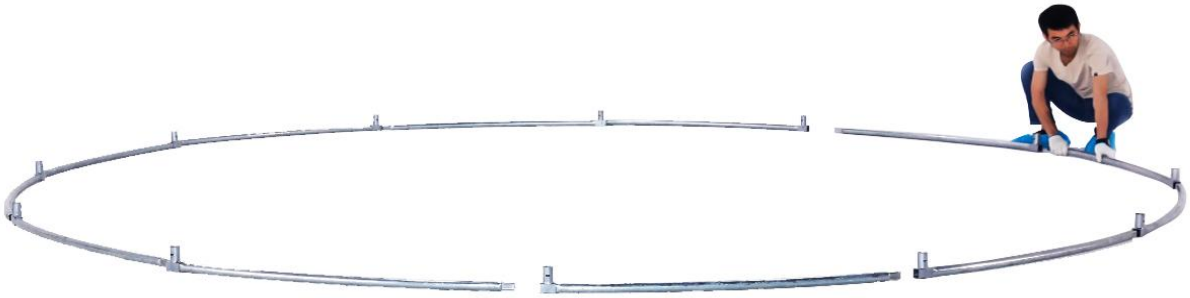

Step 2

Insert the Leg Extension (#7) into the Base Leg (#6). Make sure the holes are aligned and use the Short Screws (#18) through the locking holes, Washer (#19) and Lock Nut (#22) and tighten them. **(Make sure that the concave side of the Leg Extension (#7) faces the outer side, the side with label “OUTWARD!!!” of the Base Leg (#6) face the outer side)**







Step 3

Two people will be necessary at this point to assemble the trampoline. Lift the U-shaped leg tubes and insert into the T-shaped Connector (#5), then done the others as this. **(Make sure that the concave side of the Leg Extension (#7) faces the outer side, the side with label "OUTWARD!!!" of the Base Leg (#6) face the outer side)**

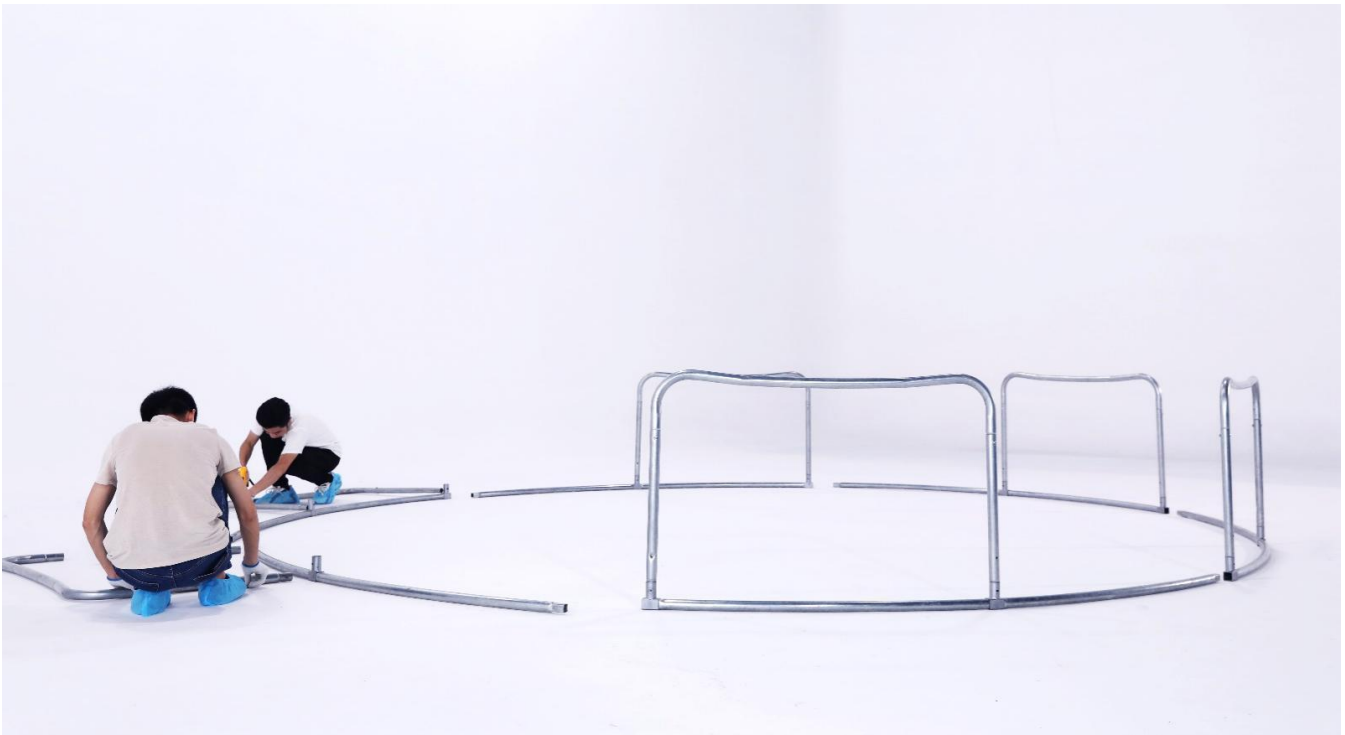



Step 4

Invert the adjacent two frames and insert the top rail into the T-shaped Connector (#5).





Step 5

Invert the frames one by one and insert all the top rails into the T-shaped Connectors (#5).



Note: After assembling the frame, temporarily insert the Long Screws (#17) into the locking holes without tightening to maintain the stability of the frame. If the T-shaped Connector (#5) holes are not aligned with the Leg Extension (#7) holes, please rotate the U-Shaped leg tube horizontally at 180 degrees (swap left and right).

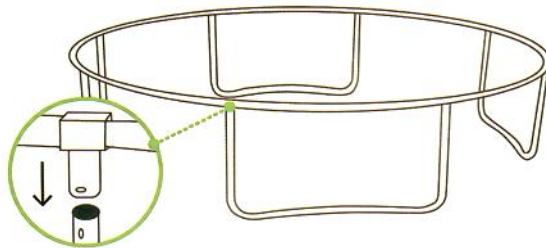



Step 6

Twist and drive the ground stakes into the soil.



Tie the black straps onto the ground stakes.



Note: This step is crucial as it enhances the stability of the trampoline, enabling it to withstand the impact of strong winds!



Step 7

Layout the Jumping Mat (#1) inside the circle frame.





Step 8

Insert one end of the Spring (#11) in the triangle ring (1st Point) of the Jumping Mat (#1) and insert the other end into the hole (1st Point) of the top rail frame.



Trampoline Spring Assembly



Step 9

Assemble the Spring (#11) in the X-shape order one by one to make sure the tension is distributed evenly for the Jumping Mat (#1). Gently tap down against the spring if the hook is not completely in the hole. Make sure the serial number of the triangular rings on the Jumping Mat (#1) and the holes on the top rail frame are the same when counting from the same direction.

Tip: Please take care not to pinch your hands and other body parts during spring assembly



X shape: 1st→37th→18th→54th→9th→45th→27th→63rd

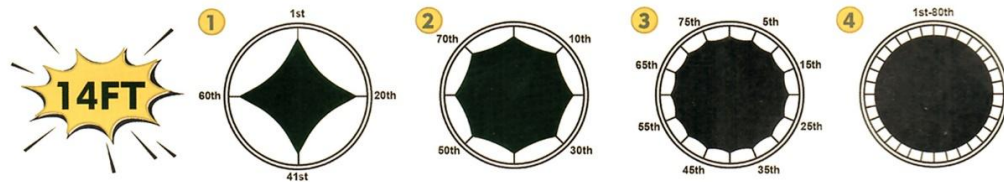

X shape: 1st→41st→20th→60th→10th→50th→30th→70th

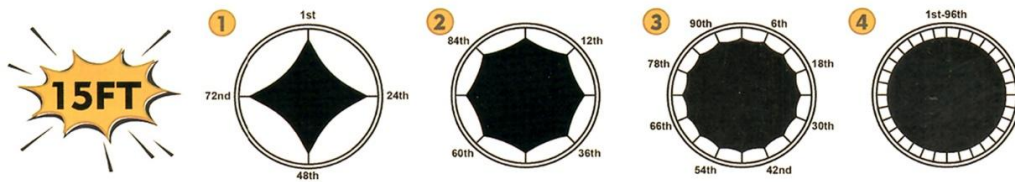

X shape: 1st→48th→24th→72nd→12th→60th→36th→84th

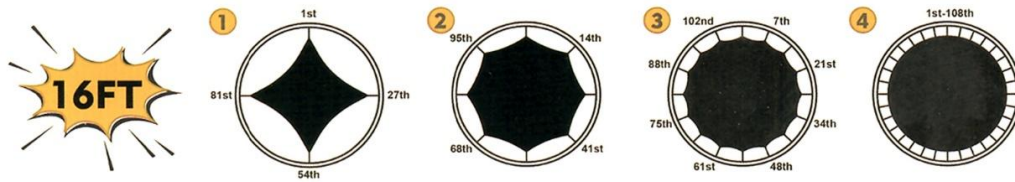

X shape: 1st→54th→27th→81st→14th→68th→41th→95th

Here we show the steps for 16ft trampoline.

1

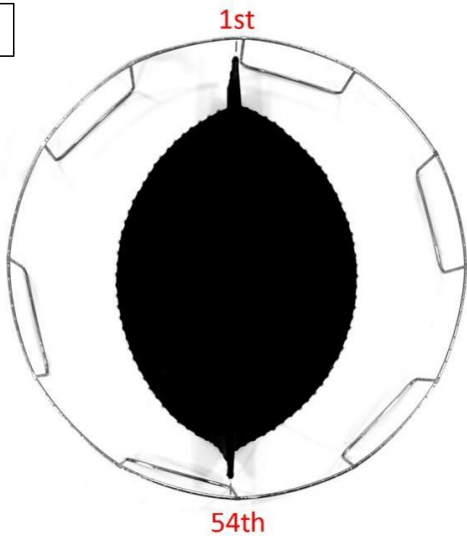

2

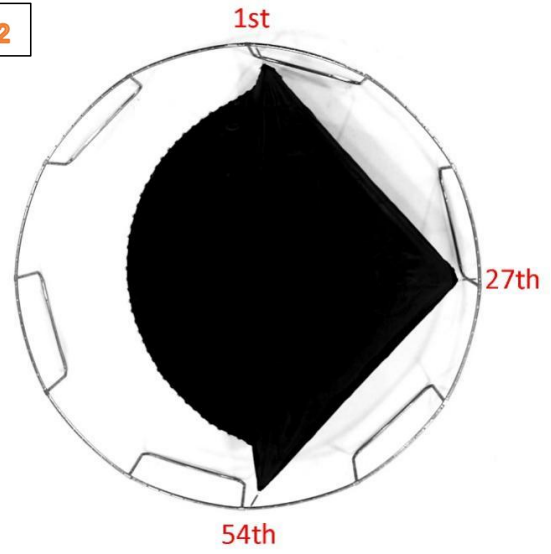

3



4



5

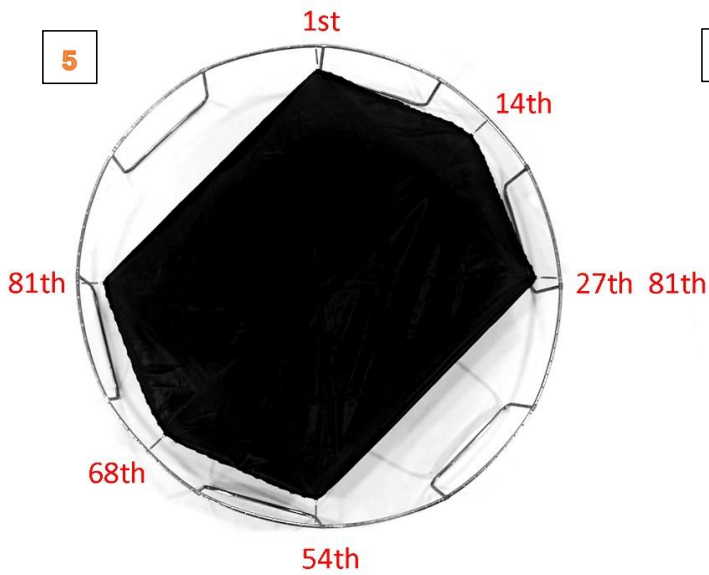

6

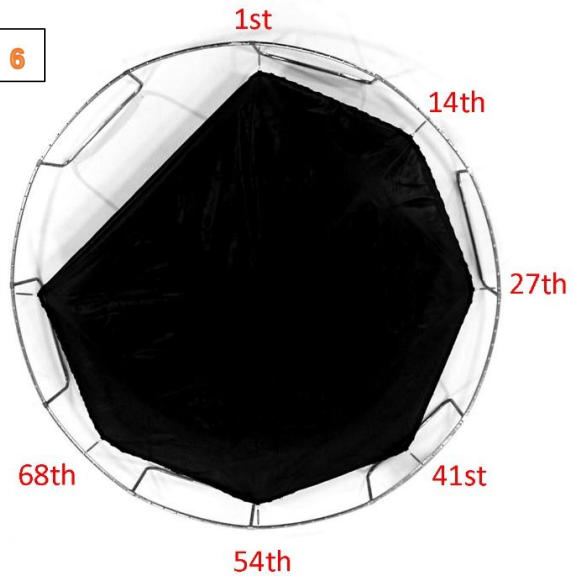

7



8



Spring Cover Pad Assembly



Step 10

Place the Spring Cover Pad (#2) on the frame and ensure it fully cover the Springs (#11) and frame. Tie the elastic strap beneath the Spring Cover Pad (#2) to the nearby Spring (#11).



Basketball Hoop Assembly



Step 11

Put the safety net (#3) on the Jumping net, and find out the T-shaped net, the side with buckle should be the outer side.





Step 12

First, Fix Basketball Hoop Ring (#23) to the Basketball Hoop Board (#24) with Board Fix Pin B (#26) and Long Screws for Board (#32).

Second, Cover the back of the Board with the T-shaped net.



Third, use two short cross screws (#15) to fix it on the assembled Back of the basketball board (#24).

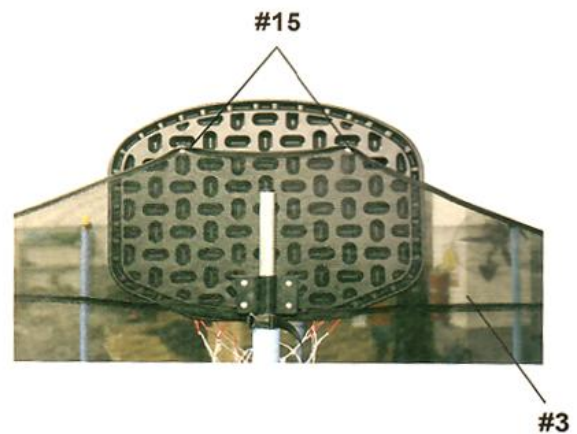

Fourth, fix Basketball Hoop Board (#24) to the Board Support Tube (#8B) with Board Fix Pin C(#27) and Short Screws for Board (#31)



Fifth, insert the Board Support Tube (#8B) into the Bottom Frame Tube (#9B)



Finally, assemble the black nylon sleeve to this whole tube.





Step 13

Insert a Long Screw (#17) through the Bottom Frame Tube (#9B), Black Gap Spacer (#20), and Leg Extension (#7) and fix them with Washer (#19) and Lock Nut (#22).

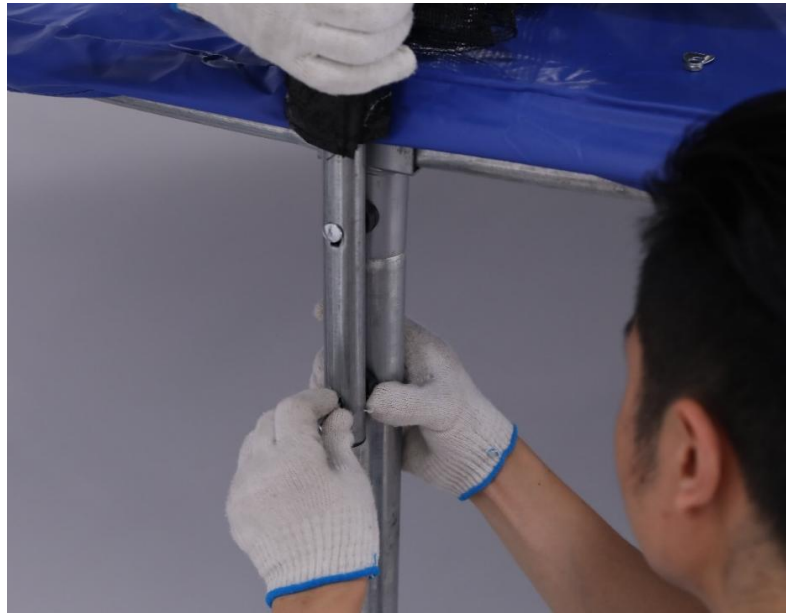
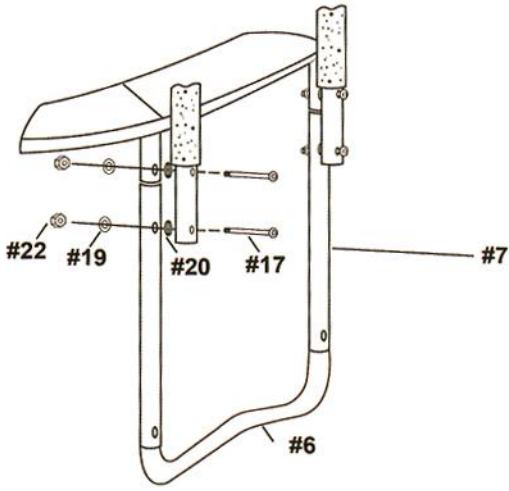

Once you have done it, it should be shown as this.





Step 14

Assemble all the Bottom Frame Tube (#9A) as Step 13.



Step 15

First, Insert the Top Frame Tube (#8A) to the Net Pole Cap (#14)



Second, ensure that the two holes are aligned, then secure it with a cone-shaped screw.



Insert all the Top Frame Tube (#8A) to all the Bottom Frame Tube (#9A)





Step 17

Assemble the black nylon sleeves to the whole tube.



Step 18

Insert the belts on the top of the safety enclosure net (#3) into the Net Pole Cap (#14) and lock the buckle, adjust the tightness of the belt as required.

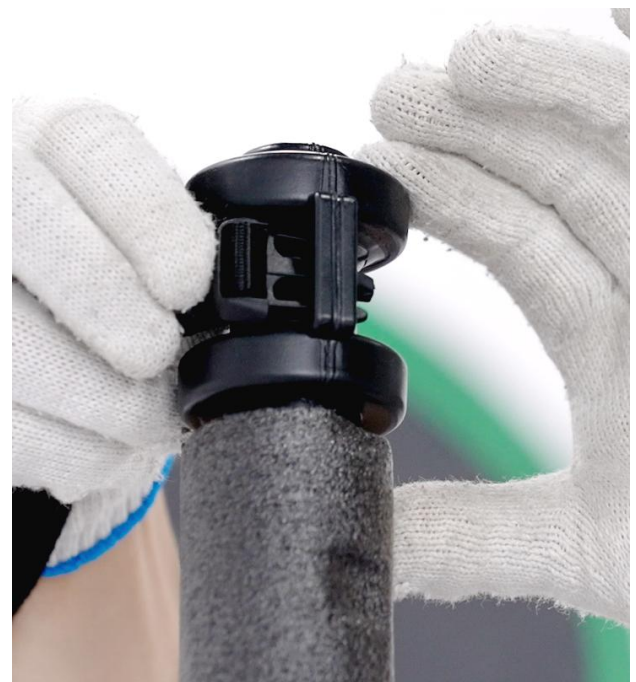

Zip up the zipper and lock the buckle of the Safety Enclosure Net (#3). Start from the point of the zipper, pull one end of the Long Rope (#16) through the bottom edge hole of the Safety Enclosure Net (#3) and the triangular ring on the Jumping Mat (#1) successively, until it meets the other end, and tie.

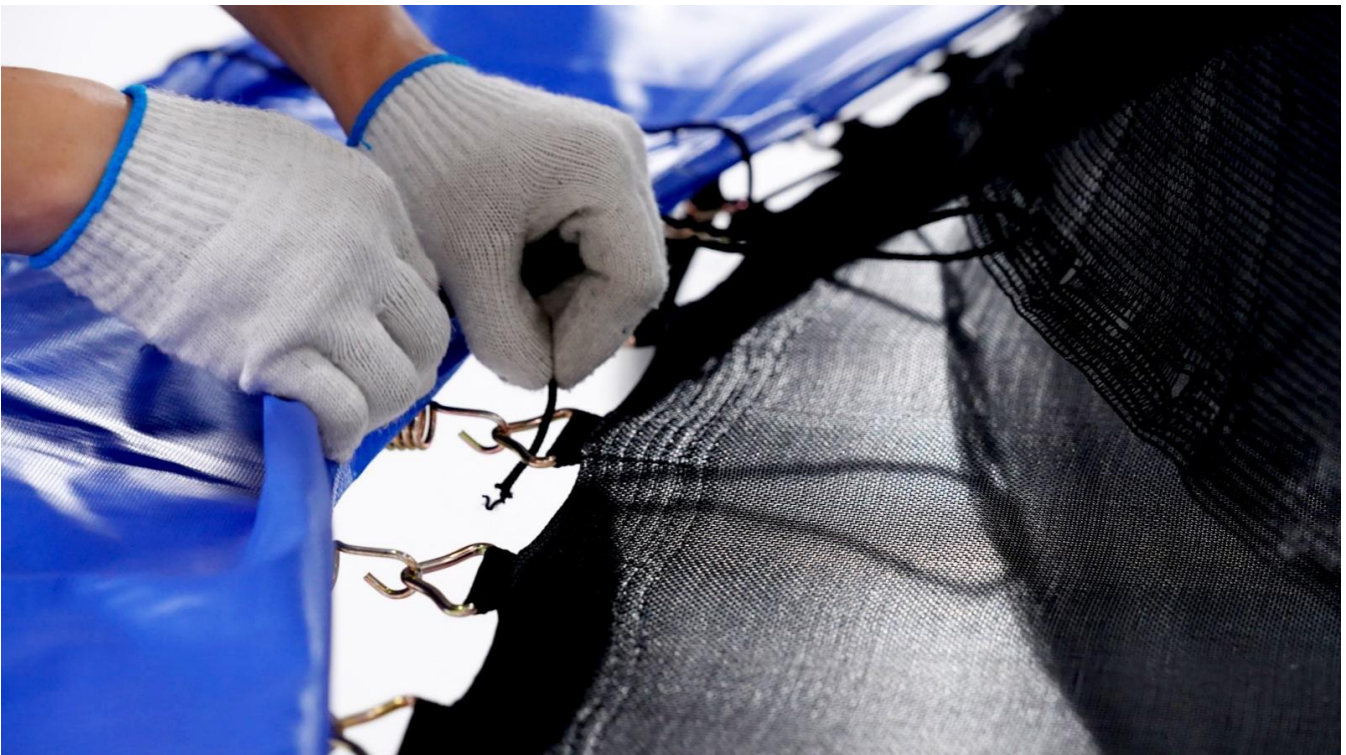



Step 19

Align the hole on Ladder Pole (#33) and Step Pole (#34) and use Ladder Screw (#35) through the locking holes, Washer (#36), Lock Nut (#37) in sequence and fix them with Allen Tool (#30).



Step 20

Hook the step ladder to the frame under the Spring Cover Pad (#2).





Step 21

Secure the hose to the top of the net with the black fastening straps.

Please note:

- 1: Pipes with holes should be placed on the inside.
- 2: In order to allow the water to flow into the hose, do not tighten the fastening strap too much.



Step 21

Use white fastening tape to secure the colored lights, water pipes, and the top of the net together.

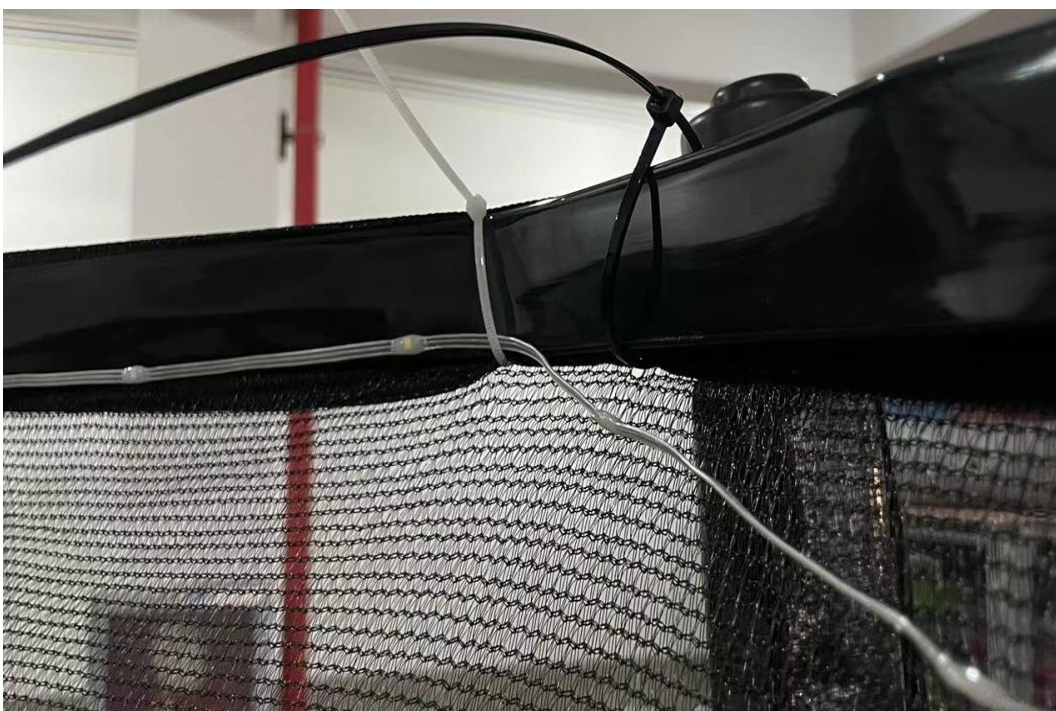

Congratulations! You have finished the assembly. Have fun with the trampoline!

The trampoline load capacity is up to 2000LBS after factory's test.

!!! NOTE: WHEN A PERSON USE THE TRAMPOLINE ALONE, THE RECOMMENDED MAXIMUM WEIGHT IS 330LBS/150KG TO AVOID INJURIES CAUSED BY A SINGLE POINT FORCE.



WARNING

Ladder helps children climb onto the trampoline. This trampoline is not recommended for children under 6 years old.

Please remove the ladder when you don't use the trampoline.



DANGER

1. Do not attempt or allow somersaults on the trampoline. It may cause serious injury, paresis or death when landing on the head or neck, even when landing in the middle of the bed.
2. Trampolines should not be used for more than 3 adults weighing more than 330lbs at a time, there is an increased likelihood of injury.
3. Children of 0-6 years old need to use the trampoline under supervision.
4. Do not use the trampoline in strong wind conditions as wind will cause unexpected movement of the trampoline. The product must be properly stored or disassembled completely in severe windy conditions.

SAFETY INSTRUCTION OF TRAMPOLINE ENCLOSURE NET



**SINGLE PERSON
WEIGHT
LIMIT: 330LBS**



**DO NOT PERFORM
SOMERSAULTS
(FLIPS) AS THIS
WILL INCREASE
YOUR CHANCES OF
LANDING ON YOUR
HEAD OR NECK!**

A. NOTICE TO SUPERVISOR

1. Supervisor is strictly to enforce the safety rules and be familiar with all the information provided in the trampoline.
2. No trampoline user shall use the trampoline without mature adult supervision, regardless of the skill or age of the trampoline user. Secure the trampoline against any unauthorized use. Keep objects away from the jumper and the trampoline that may interfere with the jumper or could be potentially hazardous.
3. The trampoline enclosure system is not recommended for use by children under the age of 6 or anyone weighing more than 330 LBS (150kg).
4. Use only when the trampoline jumping mat is clean and dry. Inspect the trampoline and enclosure before using and replacing any parts. Use only when the enclosure has no holes, pole clamps are tightly secured to the poles and the frame and the barrier is properly suspended.
5. Children must never be left unattended in the enclosure at any time.

B. NOTICE TO JUMPER

6. Do not use the trampoline and the enclosure net when one is under the influence of drugs or alcohol. Do not smoke while using the trampoline and the enclosure.
7. Avoid jumping too high or too long on the trampoline. Always control your jumping. Do not try to jump over the barrier.
8. Always have someone watch you when using the trampoline. Do not jump alone.

WARNING: MAKE SURE ALL INSTRUCTIONS ABOVE FOLLOWED

9. Do not climb on trampoline frames that are not equipped with a spring cover pad.
10. Do not wear clothing drawstrings, hooks, loops or anything that could get caught while using the trampoline/net, or it may result in entanglement or strangulation.
11. Only climb on and off the trampoline at the net door opening. Do not crawl under the trampoline frame. Do not use the trampoline as a springboard to other objects.
12. Do not jump from other objects, building or surface onto the trampoline or into the trampoline net.

⚠ WARNING

Do not jump into the enclosure netting deliberately.
Do not jump and try to hang onto the top of the netting or the enclosure pole.
Misuse of the enclosure as stated above may result in serious injury or death.
Users may become entangled in or strangled by loose cords or in gaps between trampoline and enclosure keep enclosure tightly fastened to the trampoline in accordance with the manufacturer's instructions. Failure to properly assemble and maintain a tight, secure trampoline/enclosure boundary may result in serious injury, strangulation or death.

⚠ WARNING

Your trampoline enclosure netting is manufactured with UV-resistant material. The netting is exposed to outdoor elements including sunlight, wind, rain and wildfire for a long time, so the enclosure netting must be checked before each use for wear or tear by pinching a section of fabric between fingers and pulling, stretching.
Please see the diagram below.

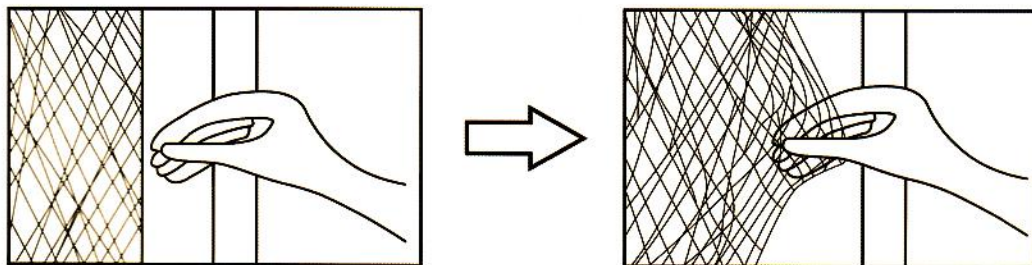

If it produces a tear or if it produces a continuous ripping sound, then the net is unsafe and must be taken down immediately. STOP USING THE TRAMPOLINE IF YOU FIND ANY SIGNS OF WEAKNESS. RESTRICT ACCESS BY USERS UNTIL A NEW AUTHORIZED REPLACEMENT NETTING IS INSTALLED OR STORE THE TRAMPOLINE.



FIZITI's design philosophy: Trampolines must be safer. FIZITI trampolines comply with ASTM F381-16 Standard Safety Specification for Components, Assembly, Use, and Labeling of Consumer Trampolines. You can rest assured that our safety materials are among the best on the market for your family.

website: <https://www.fiziti.com>

Email: service@fiziti.com



Welcome to FIZITI FAMILY! Here, you can share fun videos of you using FIZITI products, discover new items, and find discount coupons. It's also a great place to meet friends who share similar interests. Join us to enjoy a vibrant community where you can connect with others, explore exciting finds, and have a great time. We look forward to seeing you!

